

EPA-600/2-77-240  
December 1977

Environmental Protection Technology Series

# AN INTRODUCTION TO THE TECHNOLOGY OF SUBSURFACE WASTEWATER INJECTION



Robert S. Kerr Environmental Research Laboratory  
Office of Research and Development  
U.S. Environmental Protection Agency  
Ada, Oklahoma 74820

## ACKNOWLEDGMENTS

It is important that the views of the State and Federal government and industry be reflected in this document. It is imperative that it stand the critical review of those whose profession is in some way associated with subsurface wastewater injection. To that end an advisory review panel was selected to guide the development of this manual from its conception through the final manuscript. The panel was composed of the following men:

Mr. Robert R. Balmer  
E.I. DuPont DeMours & Co.

Mr. Phillip E. Lamoureux  
Geological Survey of Alabama

Mr. Robert E. Bergstrom  
Illinois State Geological  
Survey

Mr. L. E. Mannion  
Stauffer Chemical Company

Mr. Jerry Calvert  
Dowell Division  
The Dow Chemical Company

Mr. Jerry W. Mulligan  
Texas Water Quality Board

Mr. Jack Garrett  
Monsanto Company

Mr. Dwight Smith  
Halliburton Services

Mr. Allan Kerr  
Department of the Environment  
CANADA

Mr. Jack S. Talbot  
The Dow Chemical Company

Mr. Leonard A. Wood  
U.S. Geological Survey

These individuals, all expert in some facet of this text's subject matter made a continuing and comprehensive effort to insure that a significant and practical contribution was hereby made to the literature of subsurface emplacement of liquid waste.

Worthy of special mention is the contribution made by Mr. Michael D. Campbell, Consulting Geologist of Houston, Texas, who served as a consultant to the authors throughout the project. His tangible contribution is most apparent in the writing of Chapters 6 (Pre-Injection Wastewater Treatment and Surface Facility Design), 7 (Injection Well Design and Construction), 8 (Pre-Injection Preparation and Start-Up Operations), and 10 (Injection Well Abandonment).

AN INTRODUCTION TO THE TECHNOLOGY OF  
SUBSURFACE WASTEWATER INJECTION

by

Don L. Warner  
University of Missouri--Rolla  
Rolla, Missouri 65401

and

Jay H. Lehr  
National Water Well Association  
Worthington, Ohio 43085

Grant No. R-803889

Project Officer

Jack W. Keeley  
Ground Water Research Branch  
Robert S. Kerr Environmental Research Laboratory  
Ada, Oklahoma 74820

ROBERT S. KERR ENVIRONMENTAL RESEARCH LABORATORY  
OFFICE OF RESEARCH AND DEVELOPMENT  
U.S. ENVIRONMENTAL PROTECTION AGENCY  
ADA, OKLAHOMA 74820

MUNICIPAL ENVIRONMENTAL RESEARCH LABORATORY  
OFFICE OF RESEARCH AND DEVELOPMENT  
U.S. ENVIRONMENTAL PROTECTION AGENCY  
COLUMBIANA, MISSISSIPPI 39232

## DISCLAIMER

This report has been reviewed by the Robert S. Kerr Environmental Research Laboratory, U.S. Environmental Protection Agency, and approved for publication. Approval does not signify that the contents necessarily reflect the views and policies of the U.S. Environmental Protection Agency, nor does mention of trade names or commercial products constitute endorsement or recommendation for use.

## FOREWORD

The Environmental Protection Agency was established to coordinate administration of the major Federal programs designed to protect the quality of our environment.

An important part of the Agency's effort involves the search for information about environmental problems, management techniques, and new technologies through which optimum use of the Nation's land and water resources can be assured and the threat pollution poses to the welfare of the American people can be minimized.

EPA's Office of Research and Development conducts this search through a nationwide network of research facilities.

As one of these facilities, the Robert S. Kerr Environmental Research Laboratory is responsible for the management of programs to: (a) investigate the nature, transport, fate, and management of pollutants in ground water; (b) develop and demonstrate methods for treating wastewaters with soil and other natural systems; (c) develop and demonstrate pollution control technologies for irrigation return flows; (d) develop and demonstrate pollution control technologies for animal production wastes; (e) develop and demonstrate technologies to prevent, control or abate pollution from the petroleum refining and petrochemical industries; and (f) develop and demonstrate technologies to manage pollution resulting from combinations of industrial wastewaters or industrial/municipal wastewaters.

This report contributes to that knowledge which is essential in order for EPA to establish and enforce pollution control standards which are reasonable, cost effective, and provide adequate environmental protection for the American public.

*William C. Galegar*

William C. Galegar  
Director

## PREFACE

An Introduction to the Technology of Subsurface Wastewater Injection has been developed by the National Water Well Association, in conjunction with the U.S. Environmental Protection Agency for use by all those involved in the planning, design, construction, operation and abandonment of injection wells. It is hoped that this text will serve as both a guide to and a standard for injection well construction and maintenance.

For those concerned with the regulatory aspects of subsurface wastewater injection, it will provide the minimum criteria necessary to protect underground water from degradation. Industries may use this manual to evaluate injection as an alternate to other means of waste disposal and it will serve as a constant reference source for those who design, construct, and operate these systems. Finally, this manual fulfills that mandate contained in the Safe Drinking Water Act (P.L. 93-523) requiring that the Administrator of the Environmental Protection Agency ". . . carry out a study of methods of underground injection which do not result in the degradation of underground drinking water sources."

## ABSTRACT

When wastewater is injected into deep wells for disposal, it can pose a serious environmental threat unless the injection process is carefully planned and executed from start to finish.

Local geologic and hydrologic conditions must be thoroughly investigated including such characteristics as structure, stratigraphy, composition and engineering properties of the underlying formations. The nature of injection and confining intervals will determine the conditions that the injection wells must meet, or whether such wells are even feasible. Specific information acquired through the use of cores, probes, and other tests, will help to pinpoint areas of potential difficulty, and should suggest ways to avoid these problems.

Once an injection site has been selected, the injection interval must be tested to insure that it is physically, biologically, and chemically compatible with the wastewater to be injected. Both the injection interval and the wastewater must be examined to guarantee that each will remain stable over an extended period of time. If problems exist, the wastewater can be treated to make it more compatible with the injection interval. Failure to bring the wastewater and injection interval into compatibility can lead to excessive corrosion, clogging, well and plant damage, and may necessitate well abandonment.

The injection well itself must be carefully designed and constructed to guarantee the safety and integrity of the injected wastewater as well as of the surrounding formations, and natural resources. When construction of the injection well is completed, the well should undergo final testing to establish records of baseline conditions for future reference and comparison. At this time, operating procedures and emergency precautions should be established and approval should be obtained from the necessary regulatory agencies. Only then can full-scale wastewater injection begin.

An operating injection well should be monitored throughout its working life for any changes in injection conditions that may lead to system failure. An injection well operator has the responsibility of knowing what and where the injected wastewater is and for keeping adequate operating records. When an injection well system permanently ceases operating, the well must be properly sealed and a record, describing the method and date of sealing and the precise location of the well should be filed with the proper authorities. When the guidelines for injection well operation set forth here are followed the safety and success of this method of wastewater disposal will be insured.

This report was submitted in fulfillment of Grant No. R-803889 by the National Water Well Association under the sponsorship of the Robert S. Kerr Environmental Research Laboratory, Ada, Oklahoma, and the Municipal Environmental Research Laboratory, Cincinnati, Ohio, U.S. Environmental Protection Agency. This report covers a period from July 21, 1976 to July 20, 1977, and the work was completed at August 15, 1977.





## CONTENTS

Foreword . . . . .	iii
Preface . . . . .	iv
Abstract . . . . .	v
List of Abbreviations . . . . .	viii
Acknowledgments . . . . .	ix
1. Introduction . . . . .	1
Objectives and Scope . . . . .	1
Historical Review of Injection Well Use . . . . .	2
Dimensions and Units of Measurement . . . . .	8
References . . . . .	14
Appendix . . . . .	16
2. The Geologic and Hydrologic Environment . . . . .	21
Injection and Confining Intervals . . . . .	21
Rock Types . . . . .	22
Stratigraphic Geology . . . . .	22
Structural Geology . . . . .	30
Engineering Properties of Rocks . . . . .	36
References . . . . .	61
3. Acquisition and Use of Geologic and Hydrologic Data for Injection Well Site Evaluation . . . . .	64
Data Obtainable from Existing Sources Prior to Drilling . . . . .	64
Data Obtainable During Well Construction and Testing . . . . .	66
References . . . . .	120
4. Criteria for Injection Well Site Evaluation . . . . .	124
Regional Evaluation . . . . .	124
Local Site Evaluation . . . . .	140
References . . . . .	154

5.	Wastewater Characteristics . . . . .	157
	Volume . . . . .	157
	Physical Characteristics . . . . .	159
	Chemical Characteristics . . . . .	162
	Biological Characteristics . . . . .	176
	Wastewater Sampling and Analysis . . . . .	178
	Wastewater Classification . . . . .	178
	References . . . . .	182
6.	Pre-Injection Wastewater Treatment and Surface Facility Design . . . . .	188
	Plant Process Control . . . . .	188
	Treatment Processes . . . . .	190
	Injection Pumps . . . . .	218
	Examples of Integrated Treatment Facility Design . . . . .	220
	References . . . . .	230
7.	Injection Well Design and Construction . . . . .	234
	Planning a Well . . . . .	234
	Tubing and Casing Design . . . . .	243
	Packer Selection . . . . .	250
	Drilling the Well . . . . .	251
	Cementing . . . . .	265
	Casing Landing . . . . .	271
	Well Stimulation . . . . .	275
	Completion Reports . . . . .	276
	Design Examples . . . . .	277
	References . . . . .	278
8.	Pre-Injection Preparation and Start-Up Operations . . . . .	283
	Pre-Injection Testing . . . . .	283
	Operating Program . . . . .	285
	Problems Encountered During Start-Up . . . . .	286
	State Requirements for Approval of Operations . . . . .	288
	References . . . . .	292
9.	Injection Well Monitoring . . . . .	293
	Periodic Inspection and Testing . . . . .	299
	Monitoring Wells . . . . .	310
	Other Monitoring Methods . . . . .	314
	References . . . . .	317
10.	Injection Well Abandonment . . . . .	320
	References . . . . .	328
	Glossary . . . . .	329

## LIST OF ABBREVIATIONS

C	-- Centigrade
cm	-- Centimeter
cp	-- Centipoise
cu	-- Cubic
Ctgs	-- Cuttings
F	-- Fahrenheit
ft	-- Foot
gal	-- Gallons
gpm	-- Gallons per Minute
g or gr	-- Grams
in	-- Inch
ipy	-- Inches per Year
kg	-- Kilogram
m	-- Meter
mg	-- Milligrams
mg/l	-- Milligrams per Liter
mdd	-- Milligrams per Square Decimeter per Day
mgd	-- Million Gallons per Day
mpy	-- Mills per Year
min	-- Minutes
OD	-- Outside Diameter
ppm	-- Parts per Million
lb	-- Pound
psi	-- Pounds per Square Inch
psig	-- Pounds per Square Inch Gage
SpGr	-- Specific Gravity
sq	-- Square
TDS	-- Total Dissolved Solids
T	-- Transmissivity
yr	-- Year

## ACKNOWLEDGMENTS

It is important that the views of the State and Federal government and industry be reflected in this document. It is imperative that it stand the critical review of those whose profession is in some way associated with subsurface wastewater injection. To that end an advisory review panel was selected to guide the development of this manual from its conception through the final manuscript. The panel was composed of the following men:

Mr. Robert R. Balmer E.I. DuPont DeNemours & Co.	Mr. Phillip E. Lamoureaux Geological Survey of Alabama
Mr. Robert E. Bergstrom Illinois State Geological Survey	Mr. L. E. Mannion Stauffer Chemical Company
Mr. Jerry Calvert Dowell Division The Dow Chemical Company	Mr. Jerry W. Mullican Texas Water Quality Board
Mr. Jack Garrett Monsanto Company	Mr. Dwight Smith Halliburton Services
Mr. Allan Kerr Department of the Environment CANADA	Mr. Jack S. Talbot The Dow Chemical Company
	Mr. Leonard A. Wood U.S. Geological Survey

These individuals, all expert in some facet of this text's subject matter made a continuing and comprehensive effort to insure that a significant and practical contribution was hereby made to the literature of subsurface emplacement of liquid waste.

Worthy of special mention is the contribution made by Mr. Michael D. Campbell, Consulting Geologist of Houston, Texas, who served as a consultant to the authors throughout the project. His tangible contribution is most apparent in the writing of Chapters 6 (Pre-Injection Wastewater Treatment and Surface Facility Design), 7 (Injection Well Design and Construction), 8 (Pre-Injection Preparation and Start-Up Operations), and 10 (Injection Well Abandonment).

## CHAPTER 1

### INTRODUCTION

#### OBJECTIVES AND SCOPE

An Introduction to the Technology of Subsurface Wastewater Injection has been prepared to assist engineers, geologists, and others in the tasks of planning, designing, constructing, operating, and regulating industrial and municipal wastewater injection well systems. It is apparent to anyone reviewing the literature that a great deal has been written about this subject in the past twenty-five and particularly the past ten years. Also, there is an extensive literature in the related fields of petroleum engineering and ground water hydrology that can be applied to injection well technology. One purpose of this publication is, therefore, to provide a summary of selected information in a form convenient for use by well operators, engineering consultants, and regulatory authorities in performing their respective tasks, so that injection wells may be used, where desirable, more efficiently and with a minimal potential for environmental damage.

Impetus for development of An Introduction to the Technology of Subsurface Wastewater Injection was provided by passage of Public Law 92-500, the Federal Water Pollution Control Act Amendments of 1972 and Public Law 93-523, the Safe Drinking Water Act of 1974. Both of these laws contain specific provisions concerning wastewater injection wells. Public Law 92-500 requires that, in order to qualify for participation in the National Pollution Discharge Elimination System permitting program, states must have adequate authority to issue permits which control the disposal of pollutants into wells. Therefore, it is only technically necessary that a state have the authority to issue or deny permits to qualify. However, to do this it is necessary to have a program for permit evaluation. The Safe Drinking Water Act requires that EPA develop regulations for state underground injection control programs. The objective of the law is to insure that underground injection does not endanger drinking water sources. This guide is a technical document intended to complement the required EPA regulations.

Included in the technical guide are chapters concerning the units of measurement used in injection well engineering, the nature of the subsurface geologic and hydrologic environment, the means of acquiring subsurface geologic and hydrologic data, the criteria used for injection well site evaluation, the physical and chemical properties of wastewater, wastewater classification, pre-injection wastewater treatment, injection well design and construction, the procedures preparatory to injection, well operation and monitoring and system abandonment. The flow of these chapters is approximately in the order that the material is used during the planning, constructing, operating, and

abandoning an injection system. References used in the text are listed and appendices included at the end of each individual chapter.

Until the mid-1960's, the subject of the technical guide was described as deep-well disposal. Some still use this terminology. However, the majority now seem to prefer the terminology subsurface or underground injection of wastewater or waste liquid. In any case, what is being discussed here is the introduction of liquid industrial and municipal wastes into the subsurface through drilled deep-wells.

When used in this context, the word deep cannot be given any specific value, but refers to the depth required to reach a porous, permeable, saline-water-bearing rock stratum that is vertically confined by relatively impermeable beds. As will be covered later, the minimum depth of burial, the necessary thickness of confining strata, and the minimum salinity of water in the injection interval must be determined in each individual case.

Unregulated disposal of municipal and industrial wastes through shallow wells into strata containing potable ground water has been and still is practiced (TEMPO, 1973, p. 2-42 to 2-58), in spite of its obvious undesirability. In contrast to this practice, the subject here is the controlled emplacement of wastewater into the subsurface in such a manner that hazard to drinking water sources and other resources is minimized. Although much of the technology described in the engineering guide is applicable to oilfield brine disposal, oilfield brine injection is excluded from consideration because of differences in regulation and practice that make it impractical to treat it simultaneously with other industrial and municipal wastewater injection.

## HISTORICAL REVIEW OF INJECTION WELL USE

The following section provides a perspective on the historical development and recent status of wastewater injection.

It is not certain where controlled wastewater injection was first practiced outside of the oilfield, but Harlow, in an article published in 1939 (Harlow, 1939) described problems encountered by Dow Chemical Company in disposing of waste brines from chemical manufacturing by subsurface injection. Inventories by various individuals and groups have succeeded in locating no more than four such wells constructed prior to 1950. A 1963 inventory by Donaldson (1964) listed only 30 wells. Subsequent inventories published in 1967 (Warner, 1967), 1968 (Ives and Eddy, 1968), 1972 (Warner, 1972), and 1974 (U.S. EPA, 1974) listed 110, 118, 246, and 278 wells respectively. The most recent inventory (Reeder, et al, 1975) showed that a total of 322 industrial and municipal injection wells had been drilled up to January, 1975, and 209 of those were reportedly operating at that time.

Examination of some of the characteristics of the disposal systems that have been constructed will assist in developing a view of the nature of injection well practice to date. First, it is of interest to know the geographic distribution of these wells and their operating status. This information is shown in Table 1-1. It is apparent that a large percentage of the

TABLE 1-1. DISTRIBUTION AND OPERATING STATUS OF INJECTION WELLS  
IN THE UNITED STATES (REEDER, ET AL., 1975).

AREA	TOTAL NO. WELLS	O	NOP	NOUP	DN	PND	PC	SNA
REGION II								
NEW YORK	4	1			3			
REGION III								
PENNSYLVANIA	9	0	9					
WEST VIRGINIA	7	6			1			
REGION IV								
ALABAMA	5	2			3			
FLORIDA	10	4	1	1	1	3		
KENTUCKY	3	2	1					
MISSISSIPPI	2	1				1		
NORTH CAROLINA	4		1		3			
TENNESSEE	4	2		1	1			
REGION V								
ILLINOIS	8	4		1	1	1		1
INDIANA	13	11		1	1			
MICHIGAN	34	21	4	3	5	1		
OHIO	10	6	1		3			
REGION VI								
ARKANSAS	1	1						
LOUISIANA	85	52	8		5	19	1	
NEW MEXICO	1	1						
OKLAHOMA	15	10		1	4			
TEXAS	124	57	12	6	16	8	18	7
REGION VII								
IOWA	1				1			
KANSAS	30	21		2	7			
REGION VIII								
COLORADO	2		1	1				
WYOMING	1	1						
REGION IX								
CALIFORNIA	5	4		1				
HAWAII	4	1			2	1		
NEVADA	1	1						
TOTAL	383	209	38	18	57	34	19	8

KEY:

O     Operating  
 NOP   Not Operating, Plugged  
 NOUP   Not Operating, Unplugged  
 DN     Drilled, Never Used  
 PND    Permitted, Not Drilled  
 PC     Permit Cancelled, Never Drilled  
 SNA    Status Unknown

wells constructed by January, 1975 were located in Texas (91) and Louisiana (65). Most of the remainder were located in the industrialized north and east central states (Regions II, III, and V - 73 wells), Kansas (30), and Oklahoma (15), leaving only 48 wells scattered throughout the remaining states.

The distribution by industry of the 268 wells for which information was available in 1973 is shown in Table 1-2. The largest number of wells (131) had been constructed by the chemical industry, which includes petrochemical and pharmaceutical plants. Fifty-one wells had been constructed at petroleum refineries and 17 at natural gas plants. Steel mills were another major user of injection wells (16). Among the other industries that have constructed wells are a photo-processing facility, an airline maintenance shop, a paper mill, a uranium mill, a uranium processing plant, a petroleum service company, an automobile plant, a laundromat, two food-processing plants, an acid-leach mining operation, a coal mine, several solution mining operations, and an electronic components plant. In Oklahoma and Texas, several wells are operated by contractors that are collecting and injecting a variety of wastes from contracting industries. The 1973 survey listed 23 wells constructed for injection of municipal wastewater, which may also include industrial wastes discharged into sanitary sewers.

As will be discussed later in detail, nearly all types of rocks can, under favorable circumstances, have sufficient porosity and permeability to accept large quantities of injected wastewater. However, in practice, most wells have been constructed to inject into sand or sandstone (62 percent) and limestone or dolomite (33.8 percent). A very few wells have injected into other types of rocks, including shale, salt and other evaporites, igneous and metamorphic rocks, and various other combinations (Table 1-3). The ages of these rocks range from Quaternary to Precambrian (Table 1-3). One hundred and six (106) wells were completed in strata of Tertiary or Quaternary age, 93 in sand and sandstone and 13 in limestone or evaporite. Only 20 wells were completed in Mesozoic age strata, primarily sandstone. Paleozoic age strata have received the most use (143 wells). Three groups of rocks stand out as having received major use for injections: Quaternary and Tertiary age sands of the Gulf Coast geologic province of Texas, Louisiana, and Alabama; the Cambrian-Ordovician Arbuckle Group (carbonate) in Kansas and Oklahoma; and the Cambrian Mt. Simon Sandstone and its equivalents in the north-central states.

Of the injection wells that have been constructed, few are shallower than 1,000 ft. (Table 1-4). This is principally because injection intervals are selected so that they are sufficiently deep to provide adequate separation from potable subsurface water, which usually occurs at shallower depths. On the other hand, few wells deeper than 6,000 ft. have been constructed because of cost and because satisfactory intervals have usually been found at lesser depths.

Using data from the 1973 survey, Warner and Orcutt (1973) estimated that 60 percent of the wells that had operated up to that time had injected less than 100 gallons per minute (computed as if the wells were operated continuously 24 hours per day 365 days per year) and 95 percent were injecting



TABLE 1-2. STANDARD INDUSTRIAL CLASSIFICATION OF 268 INJECTION WELLS -  
1973 (U.S. ENVIRONMENTAL PROTECTION AGENCY, 1974).

	<u>WELLS</u>	<u>PERCENTAGE</u>
<u>MINING (9.3%)</u>		
10 METAL MINING	2	.7
12 COAL	1	.4
13 OIL & GAS EXTRACTION	17	6.4
14 NON-METALLIC MINING	5	1.9
<u>MANUFACTURING (80.6%)</u>		
20 FOOD	6	2.2
26 PAPER	3	1.1
28 CHEMICAL & ALLIED PRODUCTS	131	48.9
29 PETROLEUM REFINING	51	19.0
32 STONE & CONCRETE	1	.4
33 PRIMARY METALS	16	5.9
34 FABRICATED METALS	3	1.1
35 MACHINERY - EXCEPT ELECTRONICS	1	.4
36 ELECTRONICS	1	.4
38 PHOTOGRAPHICS	3	1.1
<u>TRANSPORTATION, GAS, AND SANITARY SERVICES (9.8%)</u>		
47 TRANSPORTATION SERVICE	1	.4
49 SANITARY SERVICE	23	8.6
50 WHOLESALE TRADE - DURABLE	1	.4
55 AUTO DEALERS & SERVICE	1	.4
<u>OTHER (.4%)</u>		
72 PERSONAL SERVICE	1	.4

TABLE 1-3. RESERVOIR ROCK TYPE AND AGE OF 269 WELLS  
(U.S. ENVIRONMENTAL PROTECTION AGENCY, 1974).

	(%)	SAND & SANDSTONE	CARBONATE	EVAPORITE	SHALE	OTHER
TERTIARY & QUATERNARY	39.4	93	11	2		
CRETACEOUS		19				
JURASSIC	7.4					
TRIASSIC		1				
PERMIAN		12	14	2		
PENNSYLVANIAN		5	2			
MISSISSIPPIAN		4	1			
DEVONIAN	58.2	10	21		1	
SILURIAN		1	3	4		
ORDOVICIAN		2	20			
CAMBRIAN		20	19		1	
pre-CAMBRIAN	.4					1
TOTAL (269)		167	91	8	2	1
%		62.1	33.8	3	.7	.4

TABLE 1-4. WELL COMPLETION DEPTHS OF 259 WELLS (MODIFIED AFTER  
U.S. ENVIRONMENTAL PROTECTION AGENCY, 1974).

DEPTH	NO. WELLS	PERCENTAGE
0 - 1000	20	7.7
1001 - 2000	56	21.6
2001 - 3000	33	12.7
3001 - 4000	34	13.1
4001 - 5000	39	15.1
5001 - 6000	44	17.0
6001 - 7000	18	6.9
7001 - 8000	12	4.6
8001 +	3	1.2

less than 400 gallons per minute. Warner and Orcutt (1973) also found that virtually all wells had injected at less than 1,500 psi and that 78 percent had injected at less than 600 psi.

## DIMENSIONS AND UNITS OF MEASUREMENT

In many fields of engineering and science, specialized units of measurement have been developed either for an express purpose or by circumstance without a purpose.

Such units become familiar to those using them, but can be an irritation to workers from other fields who may have neither the time nor patience to adjust to them. This has long been an obstruction to exchange of information between workers in petroleum engineering and groundwater hydrology. Since these are the two fields most closely allied to subsurface wastewater injection, the literature concerning wastewater injection contains a heterogeneous mix of terms and units from both, as well as from such other allied fields as civil and chemical engineering.

Upon examination, it can be ascertained that most of the troublesome units of measurement are composed of one or more of three primary quantities, length [L], mass [M] and time [t]. These quantities or dimensions are expressed, for example, in metric units--centimeters, grams, seconds, or English units--feet, pounds, seconds, or multiples and subdivisions of these. Other primary quantities (e.g. temperature -[T]) also exist, but are less frequently encountered. It would not be too troublesome to convert from the primary quantities in one system of units to those in another, but, unfortunately, the primary quantities are used in such mixtures and so obscured in "practical" units that it can be very difficult to work out the conversions. However, if it is understood that only the three primary quantities of length, mass, and time are involved, then the relationship between practical units in different systems can be appreciated and transfer can be confidently made from one system to another, when necessary, by using conversion factors that are given, or by working out the needed factors.

As an elementary example of the above discussion, consider the measurement of flow rates. Flow rates (Q) are commonly in barrels/day in petroleum engineering and in gallons/minute or gallons/day in groundwater. Obviously, flow rate has the dimensions of volume/time [L<sup>3</sup>/t], but this is well hidden in the practical units, barrels and gallons. Both barrels and gallons can be converted to cubic meters or cubic feet, then equated, or one can go directly from barrels to gallons, if it is known that one barrel equals 42 gallons.

As a more complex example, the conversion from units of hydraulic conductivity to those of intrinsic permeability will be analyzed. Darcy's law, as it is written for units of hydraulic conductivity is:

$$Q = AK \frac{dh}{dL} \quad (1-1)$$

where:

$$Q = \text{flow rate } [L^3/t]$$

$$A = \text{area through which flow occurs } [L^2]$$

$$K = \text{hydraulic conductivity}$$

$$h = \text{hydraulic head } [L]$$

$$L = \text{length of flow path } [L]$$

by analyzing the dimensions in Equation 1-1, the dimensions of hydraulic conductivity are found to be:

$$[K] = \frac{L^3/t}{L^2} \times \frac{L}{L} = \frac{L}{t}$$

Placement of the left hand side of an equation in brackets is a conventional means of stating that the bracketed quantity has the dimensions given on the right hand side, in this case length divided by time.

Similarly, Darcy's law written for intrinsic permeability is:

$$Q = A \bar{K} \frac{\rho g}{\mu} \frac{dh}{dL} \quad (1-2)$$

where:

$$\bar{K} = \text{intrinsic permeability}$$

$$\rho = \text{density } [M/L^3]$$

$$g = \text{acceleration of gravity } [L/t^2]$$

$$\mu = \text{viscosity } [M/Lt]$$

by analysis of the dimensions for the quantities in Equation 1-2

$$[K] = \frac{L^3/t}{L^2} \times \frac{M/Lt}{M/L^3 \cdot L/t^2} \times L = L^2$$

From examination of Equations 1-1 and 1-2, it is apparent that:

$$K = K \frac{\rho g}{\mu} \quad (1-3)$$

and

$$[K] = \frac{L/t}{M/L^3 \cdot L/t^2} = L^2$$

Using equation 1-3, the conversion from hydraulic conductivity in cm/sec to intrinsic permeability in  $\text{cm}^2$  at  $20^\circ\text{C}$  is:

$$\bar{K} = \frac{1 \text{ cm/sec} \times 1.005 \times 10^{-2} \text{ gm/cm} \cdot \text{sec}}{0.998 \text{ gm/cm}^3 \times 980.7 \text{ cm/sec}^2}$$

$$\bar{K} = 1.027 \times 10^{-5} \text{ cm}^2$$

Conversion from U.S. Geological Survey hydraulic conductivity units in gallons/day  $\times \text{ft}^2$  or ft/day to oilfield units of intrinsic permeability in darcys is made in the same way, but is more complicated because the darcy is defined by an inconsistent mixture of values and at  $20^\circ\text{C}$ , whereas the U.S.G.S. units are defined at  $60^\circ\text{F}$ . However, realizing that the conversion is basically similar to the one shown above, one can accept the conversion values that have been worked out and are contained in tables such as Table 1-5.

Because it cannot be anticipated what system of units will be provided in any particular case, most of the equations in the remaining chapters have been left in nonunitized form. That is, the equations include the correct group of symbols, but no set of units has been chosen, so that any set appropriate to the data available can be used. This does, however, require that the user understand how to accomplish the unitization, as has been explained. To assist the reader, an appendix of units and conversion factors is given at the end of this chapter.

As one example of such unitization, the equation for increase of hydraulic head in the vicinity of an injection well, which is introduced in Chapter 4, will be used. The equation is:

$$\Delta h = \frac{2.30Q}{4 \pi T} \log \frac{2.25 Tt}{r^2 S} \quad [L] \quad (1-4)$$

where

$\Delta h$  = hydraulic head change at radius  $r$  and time  $t$  [L]

$Q$  = injection rate [ $L^3/t$ ]

$T$  = transmissivity [ $L^2/t$ ]

$S$  = storage coefficient [dimensionless]

$t$  = time since injection began [t]

$r$  = distance from well bore to point of interest [L]

Any set of consistent units can be entered into this equation. For example, if  $Q = \text{ft}^3/t$ ,  $T = \text{ft}^2/\text{day}$ ,  $t = \text{days}$ , and  $r = \text{ft}$ , then  $\Delta h$  will be in ft. However, if  $Q = \text{gpm}$ ,  $T = \text{gpd/ft}$ ,  $t = \text{days}$ , and  $r = \text{ft}$ , then the appropriate conversions must be entered to obtain consistent units. In this case, the conversions are:

TABLE 1-5. CONVERSION TABLE FOR HYDRAULIC CONDUCTIVITY UNITS

	cm/sec	m/sec	m/day	ft/sec	ft/day	gpm/ft <sup>2</sup>	gpd/ft <sup>2</sup>
1 cm/sec	1.000	$1.000 \times 10^{-2}$	864.0	$3.281 \times 10^{-2}$	$2.835 \times 10^3$	14.72	$2.121 \times 10^4$
1 m/sec	$1.000 \times 10^2$	1.000	$8.640 \times 10^4$	3.281	$2.835 \times 10^5$	$1.472 \times 10^3$	$2.121 \times 10^6$
1 m/day	$1.157 \times 10^{-3}$	$1.157 \times 10^{-5}$	1.000	$3.797 \times 10^{-5}$	3.281	$1.704 \times 10^{-2}$	24.54
1 ft/sec	30.48	$30.48 \times 10^{-2}$	$2.633 \times 10^4$	1.000	$8.640 \times 10^4$	$4.488 \times 10^2$	$6.464 \times 10^5$
1 ft/day	$3.528 \times 10^{-4}$	$3.528 \times 10^{-6}$	$3.048 \times 10^{-1}$	$1.157 \times 10^{-5}$	1.000	$5.194 \times 10^{-3}$	7.480
1 gpm/ft <sup>2</sup>	$6.791 \times 10^{-2}$	$6.791 \times 10^{-4}$	58.67	$2.228 \times 10^{-3}$	$1.925 \times 10^2$	1.000	$1.440 \times 10^3$
1 gpd/ft <sup>2</sup>	$4.716 \times 10^{-5}$	$4.716 \times 10^{-7}$	$4.075 \times 10^{-2}$	$1.547 \times 10^{-6}$	$1.337 \times 10^{-1}$	$6.944 \times 10^{-4}$	1.000

CONVERSION TABLE FOR TRANSMISSIVITY UNITS

	m <sup>2</sup> /sec	m <sup>2</sup> /day	ft <sup>2</sup> /min	ft <sup>2</sup> /day	gpm/ft	gpd/ft	darcy · ft/cp
1 m <sup>2</sup> /sec	1.000	$8.64 \times 10^4$	$6.459 \times 10^2$	$9.301 \times 10^5$	$4.831 \times 10^3$	$6.957 \times 10^6$	$3.413 \times 10^5$
1 m <sup>2</sup> /day	$1.157 \times 10^{-5}$	1.000	$7.476 \times 10^{-3}$	10.76	$5.592 \times 10^{-2}$	80.52	3.950
1 ft <sup>2</sup> /min	$1.548 \times 10^{-3}$	$1.338 \times 10^2$	1.000	$1.440 \times 10^3$	7.480	$1.077 \times 10^4$	$5.284 \times 10^2$
1 ft <sup>2</sup> /day	$1.075 \times 10^{-6}$	$9.289 \times 10^{-2}$	$6.944 \times 10^{-4}$	1.000	$5.194 \times 10^{-3}$	7.480	$3.669 \times 10^{-1}$
1 gpm/ft	$2.070 \times 10^{-4}$	17.88	$1.337 \times 10^{-1}$	$1.925 \times 10^2$	1.000	$1.440 \times 10^3$	70.64
1 gpd/ft	$1.437 \times 10^{-7}$	$1.242 \times 10^{-2}$	$9.284 \times 10^{-5}$	$1.337 \times 10^{-1}$	$6.944 \times 10^{-4}$	1.000	$4.906 \times 10^{-2}$
1 darcy · ft/cp	$2.930 \times 10^{-6}$	$2.532 \times 10^{-1}$	$1.892 \times 10^{-3}$	2.725	$1.416 \times 10^{-2}$	20.38	1.000

TABLE 1-5. (Continued)

CONVERSION TABLE FOR HYDRAULIC CONDUCTIVITY &  
INTRINSIC PERMEABILITY UNITS FOR WATER AT 20° C

	cm/sec	ft/day	gpd/ft <sup>2</sup>	cm <sup>2</sup>	darcy
1 cm/sec	1.000	2.835 X 10 <sup>3</sup>	2.121 X 10 <sup>4</sup>	1.027 X 10 <sup>-5</sup>	1.040 X 10 <sup>3</sup>
1 ft/day	3.528 X 10 <sup>-4</sup>	1.000	7.480	3.623 X 10 <sup>-9</sup>	3.669 X 10 <sup>-1</sup>
1 gpd/ft <sup>2</sup>	4.716 X 10 <sup>-5</sup>	1.337 X 10 <sup>-1</sup>	1.000	4.842 X 10 <sup>-10</sup>	4.906 X 10 <sup>-2</sup>
1 cm <sup>2</sup>	9.740 X 10 <sup>4</sup>	2.761 X 10 <sup>8</sup>	2.065 X 10 <sup>9</sup>	1.000	1.013 X 10 <sup>8</sup>
1 darcy	9.613 X 10 <sup>-4</sup>	2.725	20.38	9.870 X 10 <sup>-9</sup>	1.000



$$1 \text{ gpm} = \frac{1 \times 1440 \text{ min/day}}{7.48 \text{ gal/ft}^3}$$

$$= 192.49 \text{ ft}^3/\text{day}$$

$$1 \text{ gpd/ft} = \frac{1}{7.48 \text{ gal/ft}^3} = 0.1337 \text{ ft}^2/\text{day}$$

Equation 1-4 would then be:

$$\Delta h = \frac{(2.30) (192.49) Q}{(4 \pi) (0.1337) T} \log \frac{(2.25 \times 0.1337) T t}{r^2 S}$$

$$= \frac{264 Q}{T} \log \frac{0.30 T t}{r^2 S}$$

where

$\Delta h$  = hydraulic head change at radius  $r$  and time  $t$  [ft]

$Q$  = injection rate [gpm]

$T$  = transmissivity [gpd/ft]

$S$  = storage coefficient [dimensionless]

$t$  = time since injection began [days]

$r$  = radial distance from well bore to point of interest [ft]

A reader interested in a more extensive discussion of units and dimensions can consult one of numerous available texts on the subject, for example, Taylor (1974), Pankhurst (1964), Ipsen (1960), Sedov (1959), and Murphy (1950).

## REFERENCES - CHAPTER 1

- Donaldson, E. C. Subsurface Disposal of Industrial Wastes in the United States. U.S. Bureau of Mines Information Circular 8212. 1964. 34 pp.
- Harlow, I. F. "Waste Problem of a Chemical Company." Indus. Eng. Chemistry. Vol. 31. 1939. pp. 1345-1349.
- Ipsen, D. C. Units, Dimensions, and Dimensionless Numbers. McGraw-Hill Book Company, New York. 1960.
- Ives, R. E., and Eddy, G. E. Subsurface Disposal of Industrial Wastes. Interstate Oil Compact Commission, Oklahoma City, Oklahoma. 1968. 109 pp.
- Murphy, Glenn. Similitude in Engineering. The Ronald Press Co., New York. 1950.
- Pankhurst, R. C. Dimensional Analysis and Scale Factors. Reinhold Publishing Corporation, New York. 1964.
- Reeder, Louis, et. al. Review and Assessment of Deep-Well Injection of Hazardous Waste. Final Report for EPA Contract No. 68-03-2013, Program Element No. 1DB063, Solid and Hazardous Waste Research Laboratory, Cincinnati, Ohio.
- Sedov, L. I. Similarity and Dimensional Methods in Mechanics. Academic Press, New York. 1959.
- Taylor, E. S. Dimensional Analysis for Engineers. Clarendon Press, Oxford University, London. 1974.
- TEMPO. Polluted Groundwater: Some Causes, Effects, Controls, and Monitoring. U.S. Environmental Protection Agency Publication EPA-600/4-73-001b, prepared by General Electric TEMPO, Santa Barbara, California, for the U.S. EPA, Washington, D.C. 1973.
- U.S. Environmental Protection Agency. Compilation of Industrial and Municipal Injection Wells in the United States. EPA-520/9-74-020, Office of Water Program Operations, Washington, D.C. 2 Vols. October, 1974.
- Warner, D. L. Deep-Well for Industrial Waste Injection in the United States - Summary of Data. Federal Water Pollution Control Research Series Publication No. WP-20-10. 1967. 45 pp.

Warner, D. L. Survey of Industrial Waste Injection Wells. 3 Vols. Final Report, U.S. Geological Survey Contract No. 14-08-0001-12280. University of Missouri, Rolla, Missouri. 1972.

Warner, D. L., and Orcutt, D. H. "Industrial Wastewater - Injection Wells in the United States - Status of Use and Regulation, 1973." in Underground Waste Management and Artificial Recharge. Jules Braunstein, Ed. Am. Assoc. Petroleum Geologists, Tulsa, Oklahoma. 1973. pp. 552-564.

APPENDIX - CHAPTER 1

UNITS AND CONVERSION FACTORS

LENGTH

Unit	Equivalents of First Column						
	Centi- meters	Meters	Kilo- meters	Inches	Feet	Yards	Miles
1 Centimeter	1	.01	.00001	.3937	.0328	.0109	.0000062
1 Meter	100	1	.001	39.37	3.2808	1.0936	.000621
1 Kilometer	100,000	1,000	1	39,370	3,280.8	1,093.6	.621
1 Inch	2.54	.0254	.0000254	1	.0833	.0278	.000016
1 Foot	30.48	.3048	.000305	12	1	.3333	.000189
1 Yard	91.44	.9144	.000914	36	3	1	.000568
1 Mile	160,935	1,609.3	1.6093	63,360	5,280	1,760	1

AREA

Unit	Equivalents of First Column						
	Square Centimeters	Square Meters	Square Inches	Square Feet	Square Yards	Acres	Square Miles
1 Sq. cen- timeter	1	.0001	.155	.00108	.00012	--	--
1 Sq. meter	10,000	1	1,550	10.76	1.196	.000247	--
1 Sq. inch	6.452	.000645	1	.00694	.000772	--	--
1 Sq. foot	929	.0929	144	1	.111	.000023	--
1 Sq. yard	8,361	.836	1,296	9	1	.000207	--
1 Acre	40,465,284	4,047	6,272,640	43,560	4,840	1	.00156
1 Sq. Mile	--	2,589,998	--	27,878,400	3,097,600	640	1

APPENDIX -- Continued

VOLUME

Unit	Equivalents of First Column						
	Cubic Centimeters	Cubic Meters	Liters	U.S. Gallons	Imperial Gallons	Cubic Inches	Cubic Feet
1 Cu. Centimeter	1	.000001	.001	.000264	.00022	.061	.0000353
1 Cu. Meter	1,000,000	1	1,000	264.17	220.083	61,023	35.314
1 Liter	1,000	.001	1	.264	.220	61.023	.0353
1 U.S. Gallon	3,785.4	.00379	3.785	1	.833	231	.134
1 Imperial Gallon	4,542.5	.00454	4.542	1.2	1	277.274	.160
1 Cu. Inch	16.39	.0000164	.0164	.00433	.00361	1	.000579
1 Cu. Foot	28,317	.0283	28.317	7.48	6.232	1,728	1

FLOW

Unit	Equivalents of First Column						
	Cubic Feet Per Second	Cubic Feet Per Day	U.S. Gallons Per Minute	Imp. Gallons Per Minute	U.S. Gallons Per Day	Imp. Gallons Per Day	Acre Feet Per Day
1 Cu. Foot per Sec.	1	86,400	448.83	374.03	346,323	538,860	1.983
1 Cu. Foot per Day	.0000116	1	.00519	.00433	7.48	6.233	.000023
1 U.S. Gallon per Min.	.00223	192.50	1	.833	1,440	1,200	.00442
1 Imp. Gallon per Min.	.00267	231.12	1.2	1	1,728	1,440	.0053
1 U.S. Gallon per Day	.00000186	.134	.000694	.000579	1	.833	.00000307
1 Imp. Gallon per Day	.00000186	.160	.000833	.000694	1.2	1	.00000368
1 Acre Foot per Day	.504	43,560	226.28	188.57	325,850	271,542	1

## APPENDIX -- Continued

## WEIGHT

Unit	Equivalents of First Column					
	Grams	Kilograms	Ounces (Avoir- dupois)	Pounds (Avoir- dupois)	Tons (Short)	Tons (Long)
1 Gram	1	.001	.0353	.0022	.0000011	.00000098
1 Kilogram	1000	1	35.274	2.205	.0011	.000984
1 Ounce (Avoirdupois)	28.349	.0283	1	.0625	.0000312	.0000279
1 Pound (Avoirdupois)	453.592	.454	16	1	.0005	.000446
1 Ton (Short)	907.184.8	907.185	32,000	2,000	1	.893
1 Ton (Long)	1,016,046.98	1,016.047	35,840	2,240	1.12	1

## CONVERSION TABLE

(Gallons per Minute--Gallons per Day--Cubic Feet per Second)

G.P.M.*	G.P.D.*	Sec. Ft.*	G.P.D.*	G.P.M.*	Sec. Ft.*
10	14,400	0.022	10,000	6.9	0.015
20	28,800	0.045	20,000	13.9	0.031
30	43,200	0.067	30,000	20.8	0.045
40	57,600	0.089	40,000	27.8	0.062
50	72,000	0.111	50,000	34.7	0.077
75	108,000	0.167	75,000	52.1	0.116
100	144,000	0.223	100,000	69.4	0.155
125	180,000	0.279	120,000	83.3	0.186
150	216,000	0.334	140,000	97.2	0.217
175	252,000	0.390	160,000	111.1	0.248

(Continued)

APPENDIX - Continued

CONVERSION TABLE -- Continued

G.P.M.*	G.P.D.*	Sec. Ft.*	G.P.D.*	G.P.M.*	Sec. Ft.*
200	288,000	0.446	180,000	125.0	0.015
250	360,000	0.557	200,000	138.9	0.309
300	432,000	0.668	300,000	208.3	0.464
350	504,000	0.780	400,000	277.8	0.619
400	576,000	0.391	500,000	347.2	0.774
450	648,000	1.00	600,000	416.7	0.928
500	720,000	1.11	700,000	486.1	1.08
550	792,000	1.23	800,000	555.6	1.24
600	864,000	1.34	900,000	625.0	1.39
650	936,000	1.45	1,000,000	694.4	1.55
700	1,008,000	1.56	1,200,000	833.3	1.86
750	1,080,000	1.67	1,400,000	972.2	2.17
800	1,152,000	1.78	1,600,000	1111.1	2.48
850	1,224,000	1.89	1,800,000	1250.0	2.79
900	1,296,000	2.01	2,000,000	1368.9	3.09
950	1,368,000	2.12	2,500,000	1736.1	3.87
1000	1,440,000	2.23	3,000,000	2083.3	4.64
1200	1,728,000	2.67	3,500,000	2430.6	5.42
1400	2,016,000	3.12	4,000,000	2777.8	6.19
1600	2,304,000	3.57	4,500,000	3125.0	6.96
1800	2,592,000	4.01	5,000,000	3472.2	7.74
2000	2,880,000	4.46	10,000,000	6944.4	15.5

\* - G.P.M.: U.S. Gallons per Minute  
 G.P.D.: U.S. Gallons per 24-Hour Day  
 Sec. Ft.: Cubic Feet per Second

APPENDIX - Continued

COMPARISON OF UNITS USED IN PETROLEUM INDUSTRY WITH  
UNITS USED BY GROUND WATER INDUSTRY

<u>Ground-Water Industry Unit</u>	<u>Equivalent Petroleum Industry Unit</u>
Gallon (gal.) (42 Gallons). . . . . 9,702 cu. inches 5.615 cu. feet.	1/42 Barrel (bbl.). . 1 Barrel
Q-gallons per minute (gpm) . . . . .	34.29 Barrels per day (B/D)
Drawdown in feet (s) pumping level minus static water level (SWL) ( $s_a$ ) - actual drawdown ( $s_t$ ) - theoretical drawdown of 100% efficient well	Differential pressure = 0.433 psi/ft of drawdown for water with a specific gravity of 1.0
Specific capacity (S) . . . . . gpm per foot of drawdown	Productivity index (P.I.) 79.91 B/D per psi
Permeability: . . . . .	Permeability:
meinzer - gallons per day of water at 60°F per square foot at 100% hydraulic gradient	$\frac{1}{18.24}$ darcy - cubic centimeters per second per square centimeter at one dyne per square centimeter length and viscosity of one centipoise.  54.82 millidarcy
18.24 gallons/day/sq. foot (60°F)	1 darcy
(0.01824 gals/day/sq. foot)	1 millidarcy
Transmissibility: . . . . .	Transmissibility:
gpd - ft. at prevailing temperature at 100% hydraulic gradient	$\frac{1}{20.38}$ darcy-ft. per centipoise  49.07 millidarcy-ft. per centipoise



## CHAPTER 2

### THE GEOLOGIC AND HYDROLOGIC ENVIRONMENT

Knowledge of the geologic and hydrologic characteristics of the subsurface environment at an injection well site and in the surrounding region is fundamental to the evaluation of the suitability of the site for wastewater injection and to the design, construction, operation and monitoring of injection wells. In defining the geologic environment, the subsurface rock units that are present are described in terms of their lithology, thickness, areal distribution, structural configuration and engineering properties. The chemical and physical properties of subsurface fluids and the nature of the local and regional subsurface flow system comprise the hydrologic environment. In addition, resources of present or potential value are identified to avoid endangering them through wastewater injection. The characteristics of the geologic and hydrologic environment are defined and discussed in this chapter with reference to wastewater injection.

#### INJECTION AND CONFINING INTERVALS

Vertical sequences of rocks that occur in the subsurface are conventionally subdivided by geologists into groups, formations, and members, in descending hierarchy. That is, members are subdivisions of formations and formations subdivisions of groups. Use of these terms implies mappable (traceable) rock subdivisions, based on mineralogy, fossil content, or other recognizable characteristics. However, such subdivisions may or may not be entirely suitable when discussing subsurface flow systems, because the engineering properties of porosity and permeability often do not respect geologic boundaries. This problem was long ago recognized by ground water hydrologists who developed the terms aquifer, aquiclude, aquitard, and aquifuge to describe rock subdivisions in terms of their capacity to hold and transmit water. An aquifer is defined as a formation, group of formations, or part of a formation that contains sufficient saturated permeable material to yield significant quantities of water to wells and springs. Conversely, an aquiclude stores water, but does not transmit significant amounts. An aquitard lies between the two previously defined types in that it transmits enough water to be regionally significant, but not enough to supply a well. An aquifuge neither contains nor transmits water (Davis and DeWiest, 1966; Walton, 1970). These same terms could be applied in discussing wastewater injection, and sometimes are; but other terms are more commonly used. Actual or potential receiving aquifers are commonly called the injection intervals, zones, units, or reservoirs and the intervening strata are referred to as confining intervals (aquicludes) or semi-confining intervals (aquitards). The basement sequence of igneous or metamorphic rock that lies beneath the sedimentary rock cover is generally non-porous and impermeable (aquifuge). In the

remainder of this text, injection interval will be used to describe the total vertical interval into which wastewater is being injected and injection zone will mean a subdivision of the injection interval. Other terminology, as defined above, will also be used where appropriate.

## ROCK TYPES

Rocks are described in terms of their origin and their lithology, the latter characteristic being defined by their composition and texture. By origin, the three broad rock types are classified as igneous, metamorphic, and sedimentary. While nearly all rock types can, under favorable circumstances, be capable of acting as injection intervals, sedimentary rocks, particularly those deposited in a marine environment, are most likely to have suitable geologic and engineering characteristics. These characteristics are sufficient porosity, permeability, thickness, and areal extent to permit the rock to act as a liquid-storage reservoir at safe injection pressures.

Sandstone, limestone, and dolomite are types of sedimentary rock commonly porous and permeable enough in the unfractured state to be suitable injection reservoirs. Naturally fractured limestone, dolomite, shale, and other rocks may also be satisfactory.

Unfractured shale, clay, siltstone, anhydrite, gypsum, and salt have been found to provide good seals against upward or downward flow of fluids. Limestone and dolomite may also be satisfactory confining beds; but these rocks commonly contain fractures or solution channels, and their adequacy must be determined in each case.

## STRATIGRAPHIC GEOLOGY

Study of the composition, sequence, thickness, age and correlation of the rocks in a region is stratigraphic geology or stratigraphy. The basic means of display of data used in stratigraphic studies is the columnar section, which is a graphic representation of the rock units present at a location or in a region. Figure 2-1 is a generalized columnar section for north-eastern Illinois. This particular example was selected because it shows a variety of rock types, is typical of the east-central states, and is easily interpreted and discussed. Some possible injection intervals in Figure 2-1 are indicated by the fact that they are being used for natural gas storage. One of these possible injection reservoirs, the Mt. Simon Formation, is the deepest and is overlain by the Eau Claire Formation, which may contain shale confining beds. On the other hand, the St. Peter Formation is the shallowest and is overlain by limestones and dolomites, which are less dependable for confinement. Therefore, the St. Peter has a lesser potential for wastewater injection. The Mt. Simon Formation has, in fact, been widely used for wastewater injection in Illinois, Indiana, Ohio, and adjacent states, whereas no injection wells have yet been constructed for disposal into the St. Peter Formation. In areas where there are sandstones in the Eau Claire Formation, immediately above the Mt. Simon, these can be considered along with the Mt. Simon Formation as a single injection interval (aquifer). This interval has been referred to as the Mt. Simon aquifer (Suter and others, 1959) or the "basal sandstone" (Ohio River Valley Water Sanitation Commission, 1976).

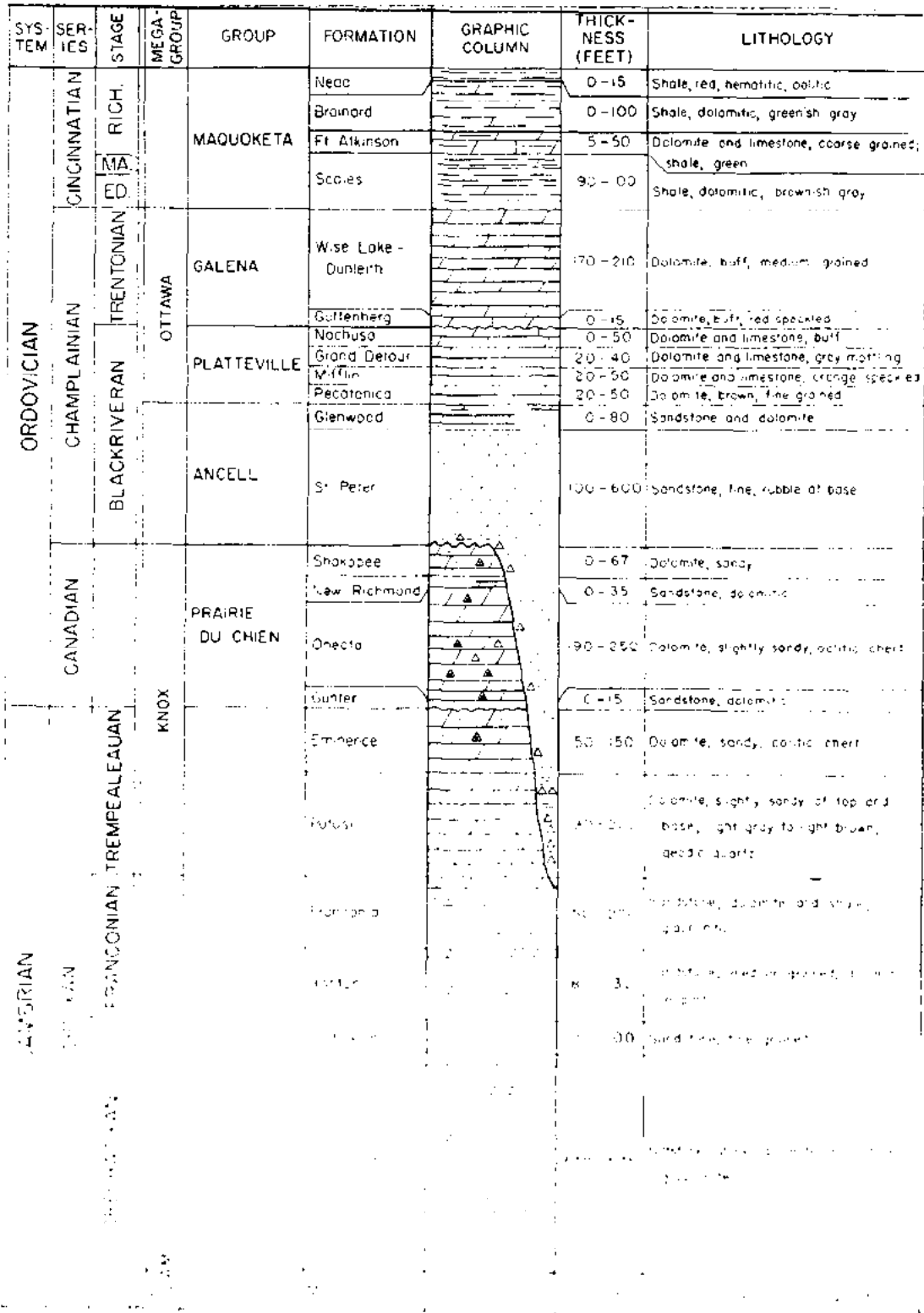

FIGURE 2-1. GENERALIZED COLUMNAR SECTION OF CAMBRIAN AND PROTEROZOIC STRATA IN NORTHEASTERN ILLINOIS. SCALE INDICATES STRATIGRAPHIC AND CHRONOLOGICAL CORRELATION.

Another means of displaying stratigraphic information is the cross section. Figure 2-2 is a west-east cross section of southeast Kansas, which has been constructed from the stratigraphic columns of 15 deep wells. This cross section was selected to show a typical stratigraphic sequence from the Kansas-Oklahoma area. In this case, the most promising injection interval is the Arbuckle Formation, which is widely used for industrial wastewater and oilfield brine disposal in Kansas and Oklahoma. The Arbuckle is composed principally of dolomite interbedded with sandstone, as is indicated by the patterns used in the cross section.

Cross sections show the thickness of rock units along a selected line, but thickness (isopach) maps are used to show this characteristic over an area. Figure 2-3 is a map showing the thickness of the Mt. Simon aquifer or basal sandstone interval in the Ohio River Basin area. As previously discussed, this basal interval includes the Mt. Simon Formation and sandstones immediately above it in the Eau Claire Formation. As can be seen in Figure 2-3, the basal sandstone of the Ohio Valley area is more than 2,500 feet thick in northeastern Illinois but disappears entirely in northern New York. Figure 2-4 shows the thickness of the confining beds in the Eau Claire Formation that overlie the basal sandstone. Thicknesses range from about 200 feet to over 600 feet. The confining interval is only shown as being present where the strata are dominantly shale and siltstone. Elsewhere the basal sandstone is overlain by sandstone, dolomite, or limestone and the effectiveness and upper boundary of the confining interval become less well defined. Other factors being equal, the thicker an injection or a confining interval, the better it will serve its purpose. However, there is no lower limit of thickness that can be established for either an injection or confining interval in general. Judgement is based on engineering as well as geologic factors and must be made for each individual case. Examples of such an evaluation will be given later.

Rock units commonly vary in their composition as they are traced laterally. Such variations are referred to as facies changes, facies being a geologic term that means appearance or aspect. For example, Figure 2-5 is a schematic west-east cross section that shows the lower Eau Claire Formation changing from a mixture of lithologies in eastern Indiana and western Ohio to sandstone in central Ohio and to dolomite in eastern Ohio. In this case, formation names also change as the lithology changes. Facies maps show such variations over an area. Some types of facies maps are ratio maps, percentage maps, and isolith maps. These would show with patterns or contours, respectively, ratios or percentages of the constituents or the aggregate thickness of one selected constituent.

Figure 2-6 shows the ratios of shale-siltstones, sandstones, and carbonates in the Eau Claire confining interval that overlies the basal sandstone (Mt. Simon aquifer) in the Ohio River basin area. Ratios are only shown where this interval is more than 50 percent shale-siltstone because, as previously explained, the effectiveness of confinement and upper boundary of the interval are less certain as the amounts of sandstone and carbonates in the confining unit increase. Comparison between Figures 2-5 and 2-6 shows that both indicate a rapid change in the lithology of the Eau Claire Formation from

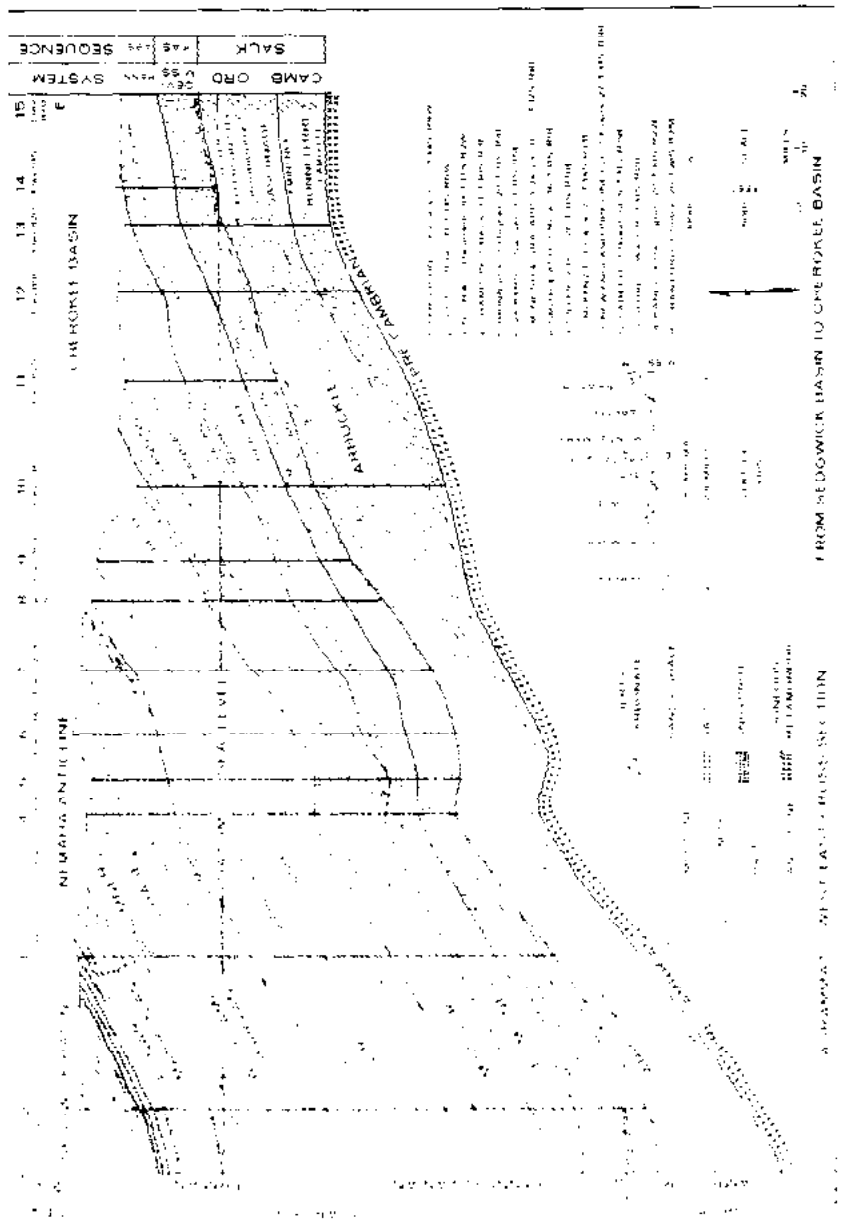

FIGURE 2-2. DIAGRAMMATIC WEST-EAST CROSS SECTION OF SOUTHEAST KANSAS SHOWING STRUCTURAL CONFIGURATION AND STRATIGRAPHY (ADAPTED BY GOBEL, 1971, FROM LEE AND MERRIAM, 1954).

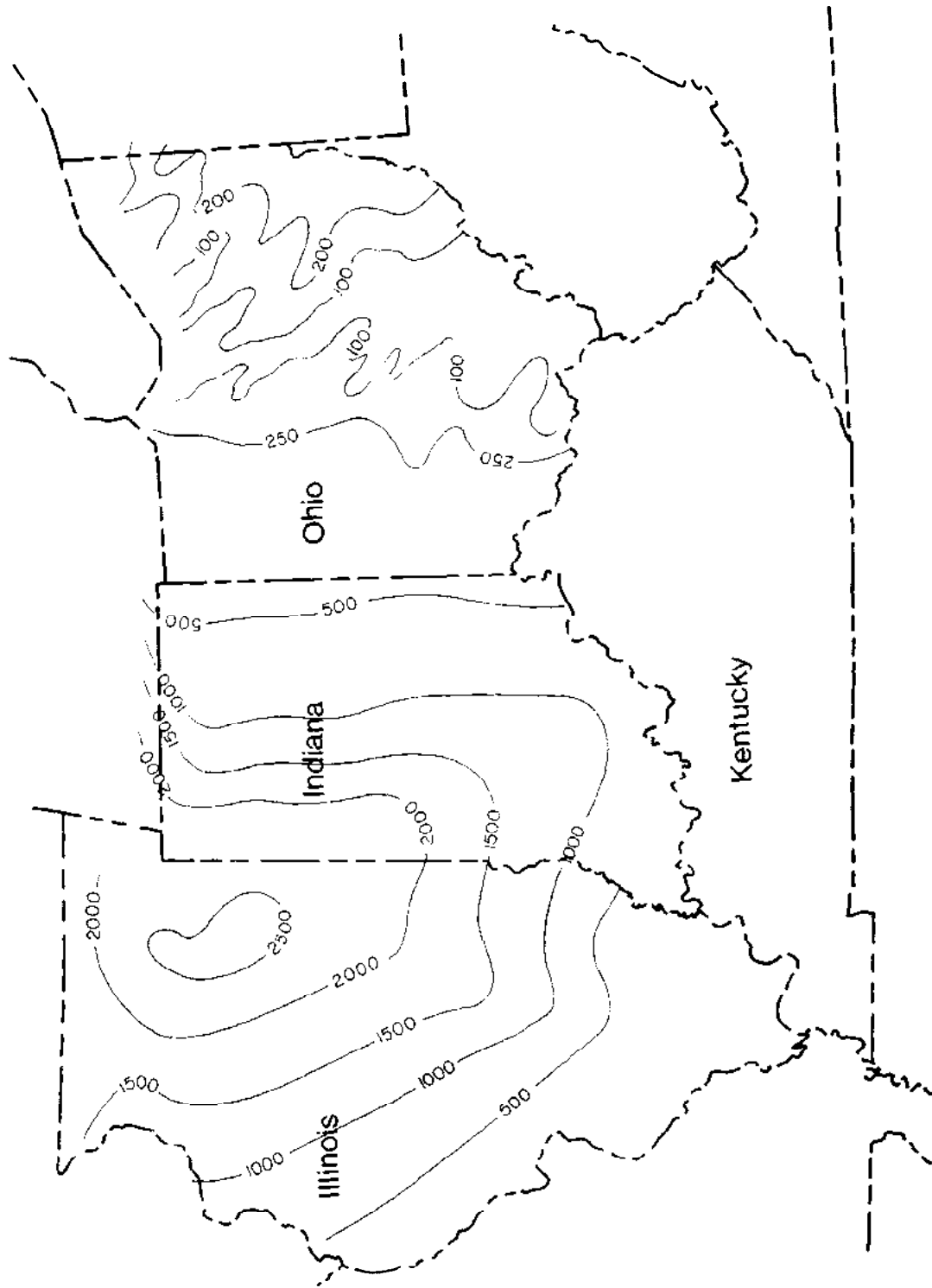

FIGURE 2-3. THICKNESS OF THE BASAL SANDSTONE OHIO RIVER BASIN AND VICINITY (OHIO RIVER VALLEY WATER SANITATION COMMISSION 1976).

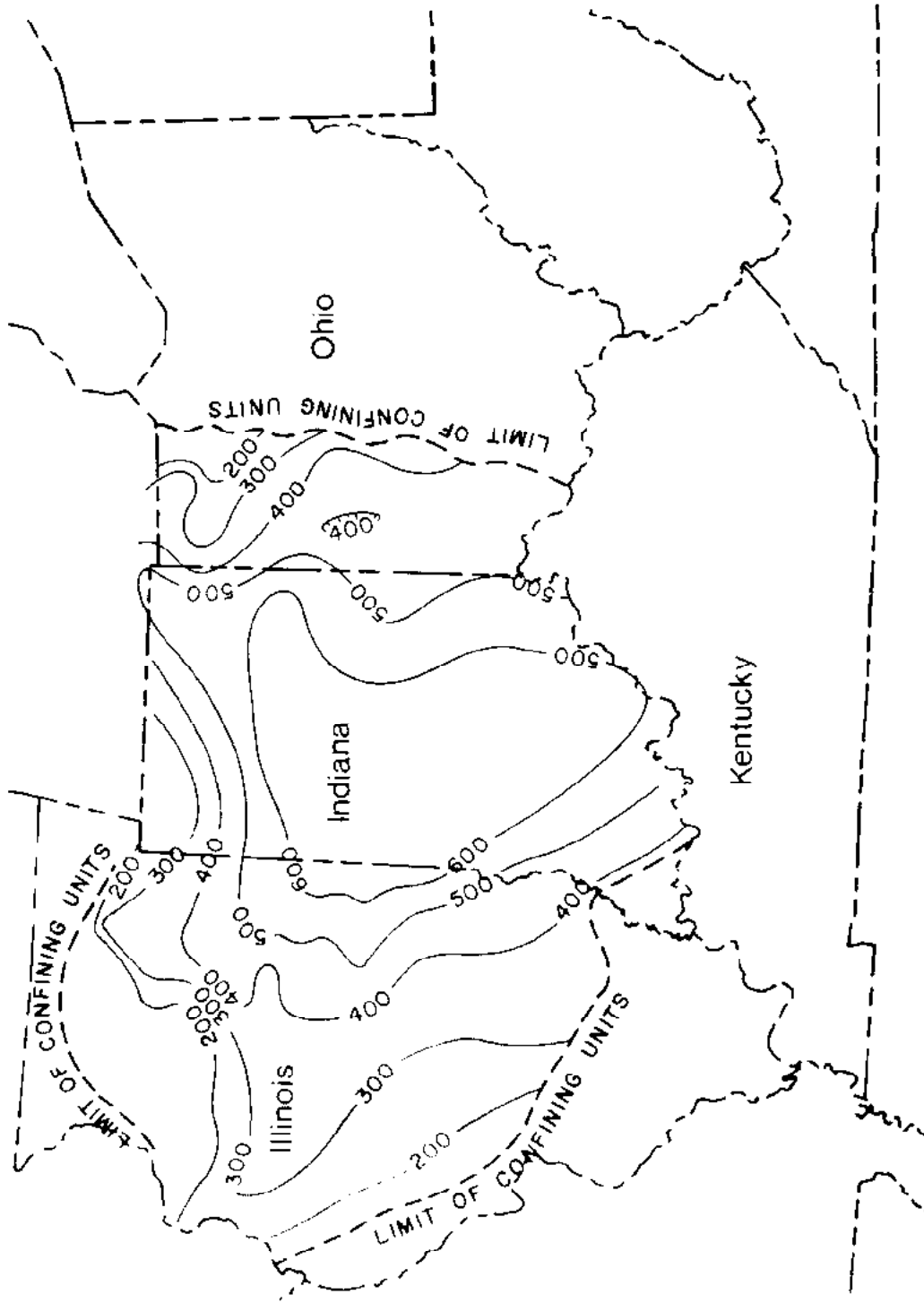

FIGURE 2-4. THICKNESS OF THE EAU CLAIRE CONFINING INTERVAL OHIO RIVER BASIN AND VICINITY (OHIO RIVER VALLEY WATER SANITATION COMMISSION 1976).

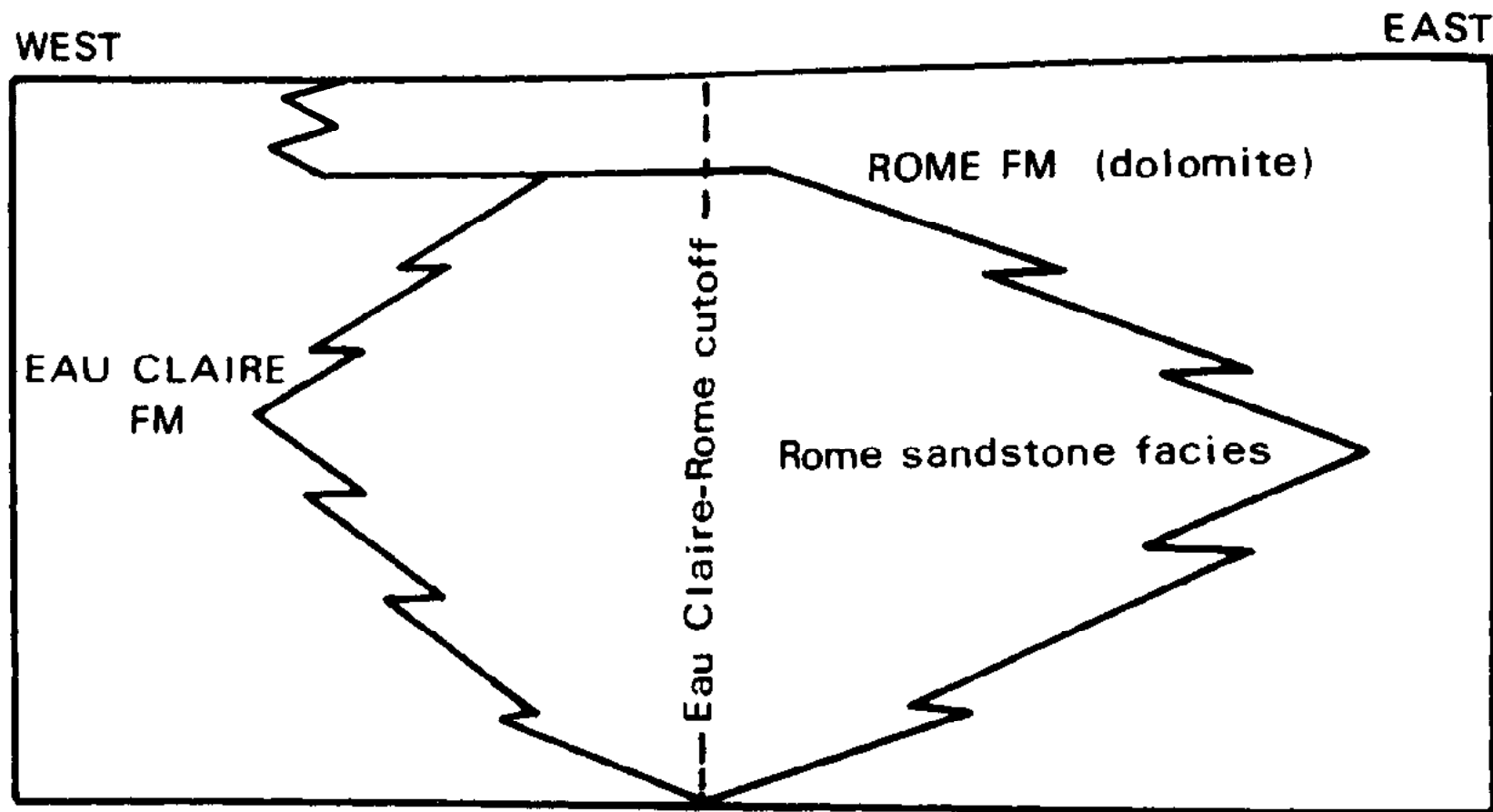

FIGURE 2-5. SCHEMATIC WEST-EAST SECTION OF THE EAU CLAIRE AND EQUIVALENT ROME STRATA (JANSSENS, 1973, P. 10).



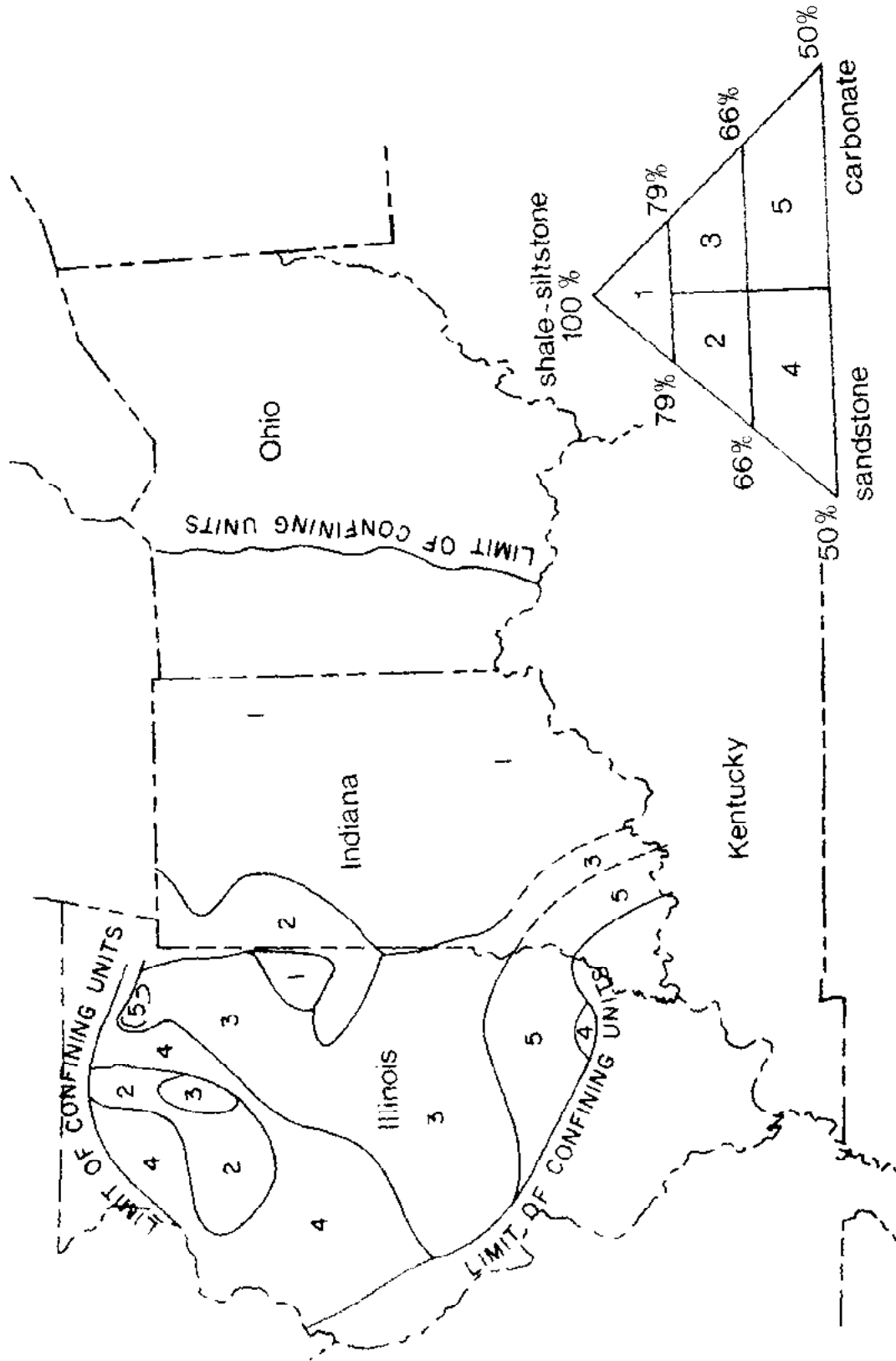

FIGURE 2-6. RATIO OF LITHOLOGIES IN THE EAU CLAIRE CONFINING INTERVAL OHIO RIVER BASIN (OHIO RIVER VALLEY WATER SANITATION COMMISSION 1976).

west to east across Ohio. Facies maps of injection intervals can, similarly, be useful in showing changes that affect their quality for injection purposes.

## STRUCTURAL GEOLOGY

Structural geology is concerned with the folding and fracturing of rocks and the geographic distribution of these features.

Structural geologic characteristics of a region and, on a smaller scale, of a particular site are significant because of their role in influencing subsurface fluid flow, the engineering properties of rocks, and the localization of mineral deposits and earthquakes. Sedimentary rocks may be folded into synclines (downward or trough-like folds) or anticlines (upward folds). Synclinal basins of a regional scale (hundreds of miles) are viewed as particularly favorable for wastewater injection as discussed in Chapter 5. On a smaller scale, petroleum occurs naturally in closed anticlinal folds. Anticlines are also used for temporary underground storage of natural gas. Therefore, many anticlinal areas in petroleum-producing states and in regions where gas storage is practiced are not available for wastewater injection. On the other hand, it has been suggested that wastes less dense than the water in the injection interval could be stored in anticlines, as is natural gas (Figure 2-7), if the anticlines were not otherwise used. Injection of wastes denser than water into closed synclinal areas might also be good practice because the wastes would tend to remain trapped there. This concept has not been employed to date, but may merit consideration in the future.

Faults are fractures in the rock sequence along which there has been displacement of the two sides relative to one another. Such fractures may range from inches to miles in length, and displacements are of comparable magnitudes. Faults may occur singly or in systems so complex that it is not possible to completely define them.

It is known, through experience, that faults may act either as barriers to fluid movement or as channels for fluid movement. However, little is known in detail about how and why some faults are barriers and others are flow channels. In theory, no fault in a sedimentary rock sequence will be an absolute barrier, but a fault may be of so much lower permeability than the aquifer it cuts that it is, for practical purposes, a barrier. Since it will seldom be possible for a geologist to initially state whether a fault is a barrier or a flow path, it would be appropriate to consider any significant fault to be a flow path for purposes of preliminary evaluation of its importance. If, as a consequence of this initial assumption, the fault would be an environmental hazard it would then be necessary to either abandon the project or to test the fault directly by methods that will be described later. A significant fault might be defined as one that is of sufficient length, displacement, and vertical persistence to provide a means of travel for injected wastewater to an undesirable location. This question is one that will have to be answered by qualified geologists and engineers on the basis of their best judgement, after a review of the data for a particular site.

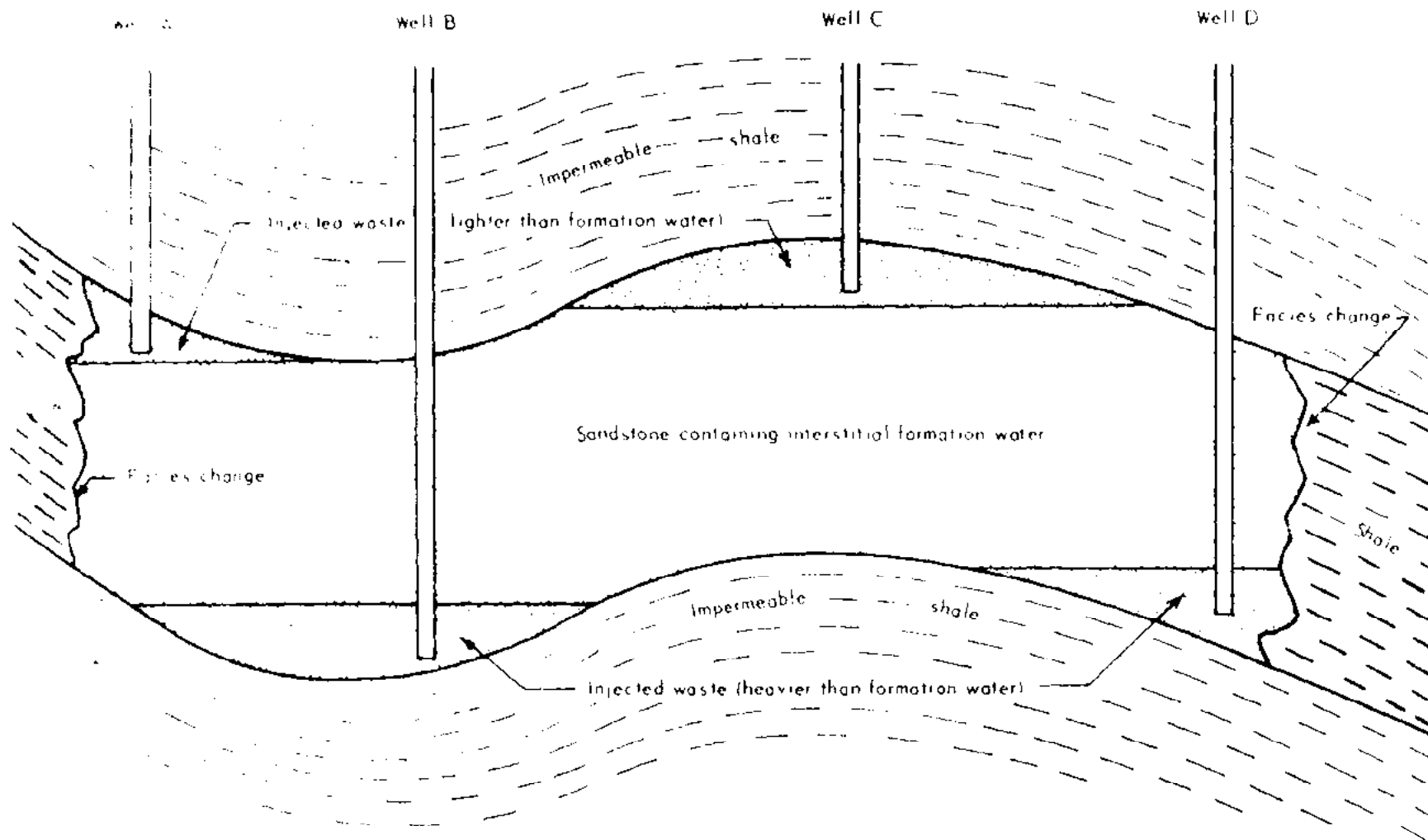

FIGURE 2-7. SCHEMATIC ILLUSTRATION OF THE CONCEPT OF STORING LIGHT WASTES IN ANTICLINES AND DENSE WASTES IN SYNCLINES (ALVERSON, 1970).

Empirical observations and considerable research have, within the past decade, led many earth scientists and engineers to the conclusion that, under the proper circumstances, subsurface fluid injection can stimulate movement along some faults. When movement occurs, stored seismic energy is released; that is, an earthquake occurs. Although much remains to be learned about this subject, it appears that the circumstances favorable to earthquake generation are relatively rare. The mechanism of earthquake generation and means of anticipating such an occurrence will be expanded upon in later sections.

Fractures also exist along which there has been no movement. This type of fracture may be referred to as a crack or joint to distinguish it from a fault. Cracks and joints are important sources of porosity and permeability in some aquifers but can be undesirable when they channel fluids rapidly away from an injection well in a single direction or where they provide flow paths through confining strata. The presence and nature of fractures is determined by examination of rock cores obtained during drilling, by well logging and testing methods, and from experience with other deep wells drilled in the same region.

Structural geologic data are displayed in maps, cross sections, and other types of figures. Major structural features are displayed in tectonic maps (regional scale) or structural geologic maps (subregional or local scale). Figure 2-8 shows the location of prominent structural geologic features in southwest Alabama, which include the Hatchetigbee anticline, the Jackson fault-Klepac dome<sup>1</sup>, the Mobile graben<sup>2</sup>, and the Gilbertown, Coffeeville-West Bend, Walker Springs, Pollard, and Bethel fault zones. Other significant structures are domal anticlines near Chatom, Citronelle, South Carlton, and the salt dome at McIntosh. Industrial disposal wells have been drilled in the Mobile graben (T. 1 S., R. 1 E., Mobile County) and on the north flank of the McIntosh salt dome (T. 4 N., R. 1 E., Washington County), which is also in the Mobile graben (see Tucker and Kidd, 1973 for further details). Figure 2-9 is a west-east structural cross section across the Mobile graben and the Klepac dome, illustrating the nature of faulting associated with the graben.

Maps that show the elevation of a particular stratigraphic horizon relative to a selected datum are structure contour maps. Structure contour maps allow an estimate of the approximate depth to the mapped unit, the direction and magnitude of dip of the unit, and also show the location of faults and folds that may influence decisions concerning the location and monitoring of a well. Figure 2-10 is a map of the configuration or structure of the top

---

<sup>1</sup>A dome is a symmetrical anticline, with the strata dipping more or less equally in all directions from the center. Salt domes, which are common in the Gulf Coast Region have been formed by the upward movement of a core of salt.

<sup>2</sup>A graben is a block of strata that has been downdropped between two faults, as is illustrated in Figure 2-9.

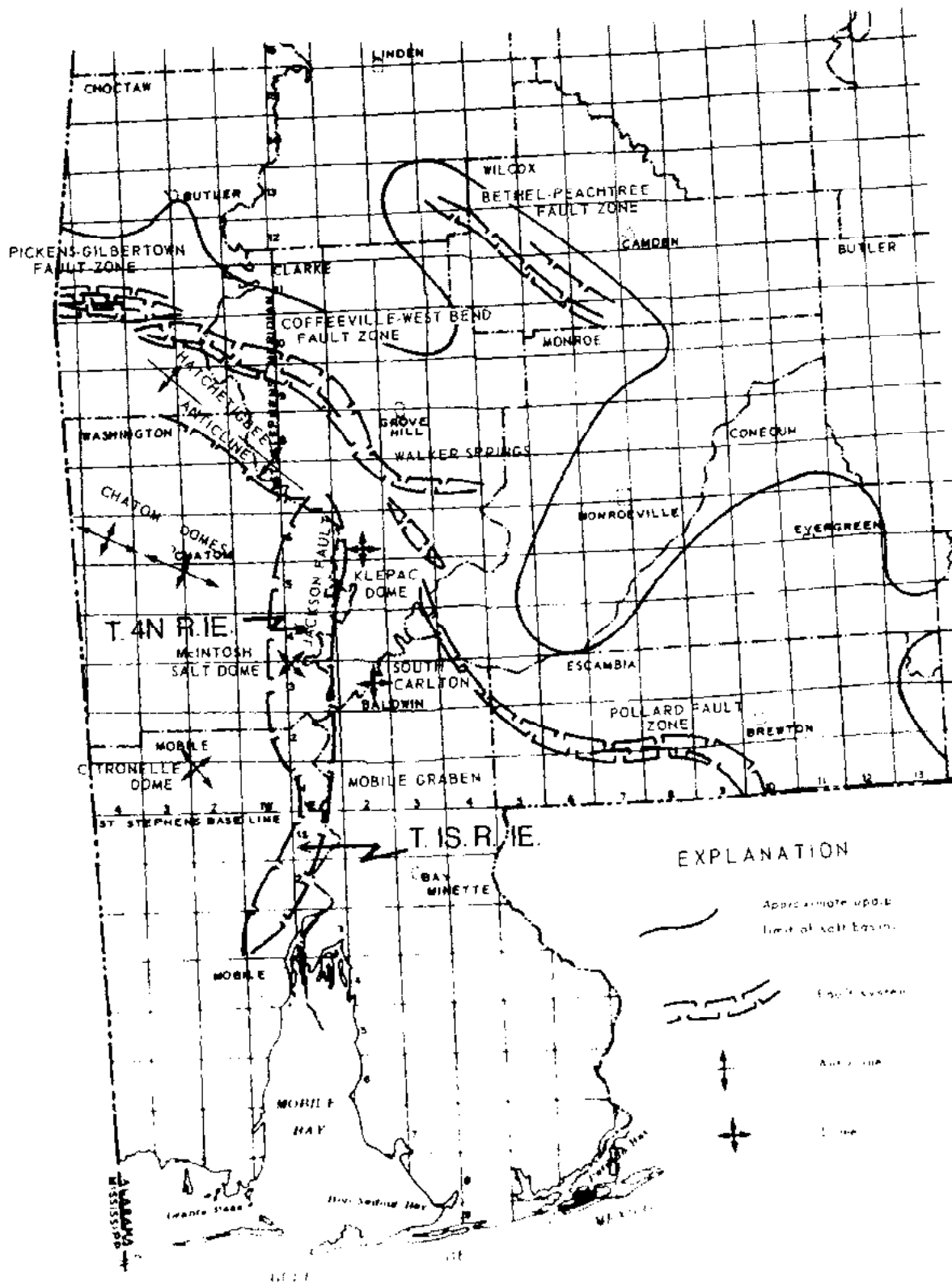

FIGURE 7-5. LOCATION OF PROMINENT STRUCTURAL FEATURES IN GULF COAST ALABAMA (CHAP. AND FIG. 7-5).

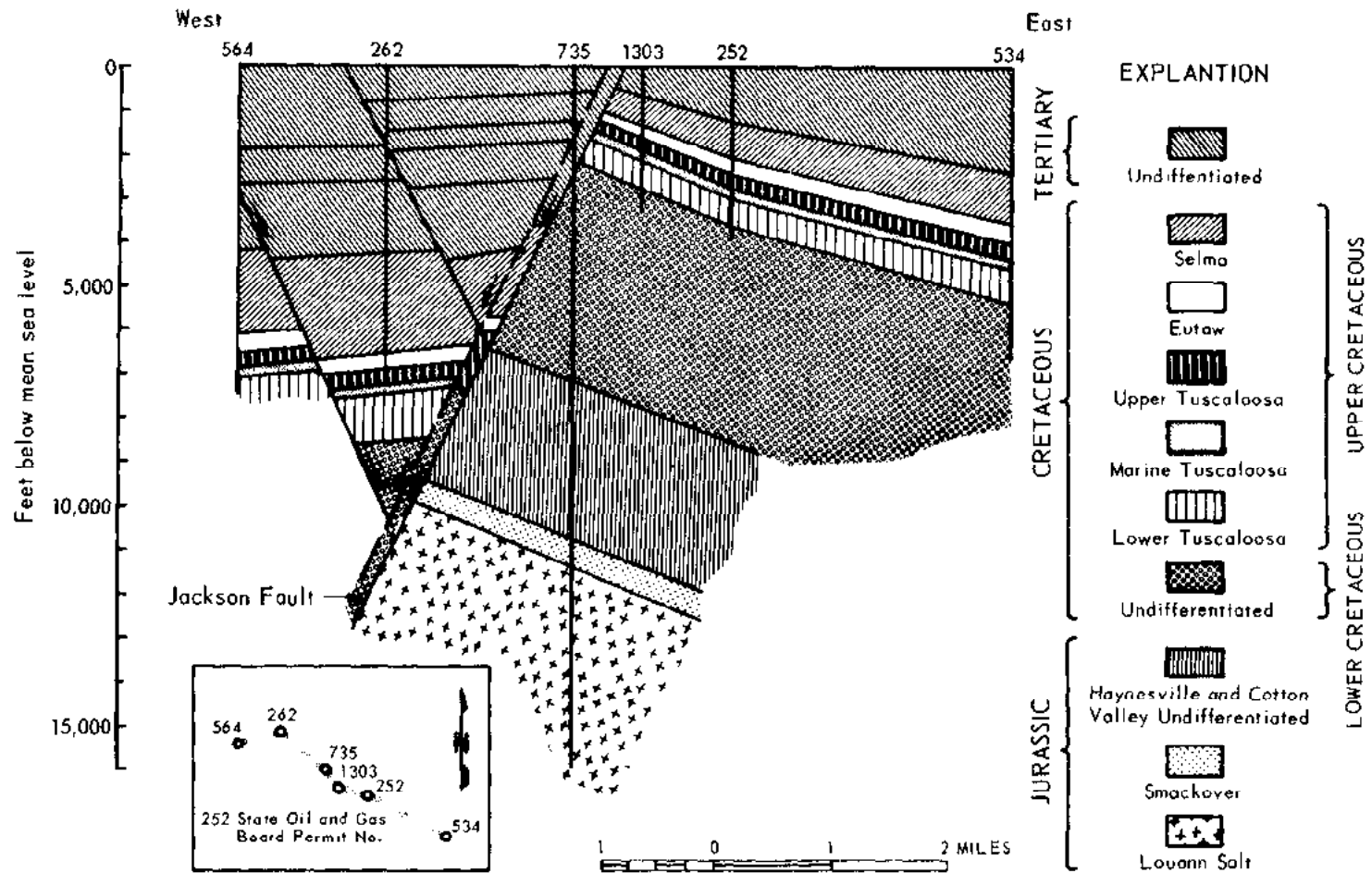

FIGURE 2-9. WEST-EAST CROSS SECTION ACROSS THE MOBILE GRABEN AND KLEPAC DOME (TUCKER AND KIDD, 1973).

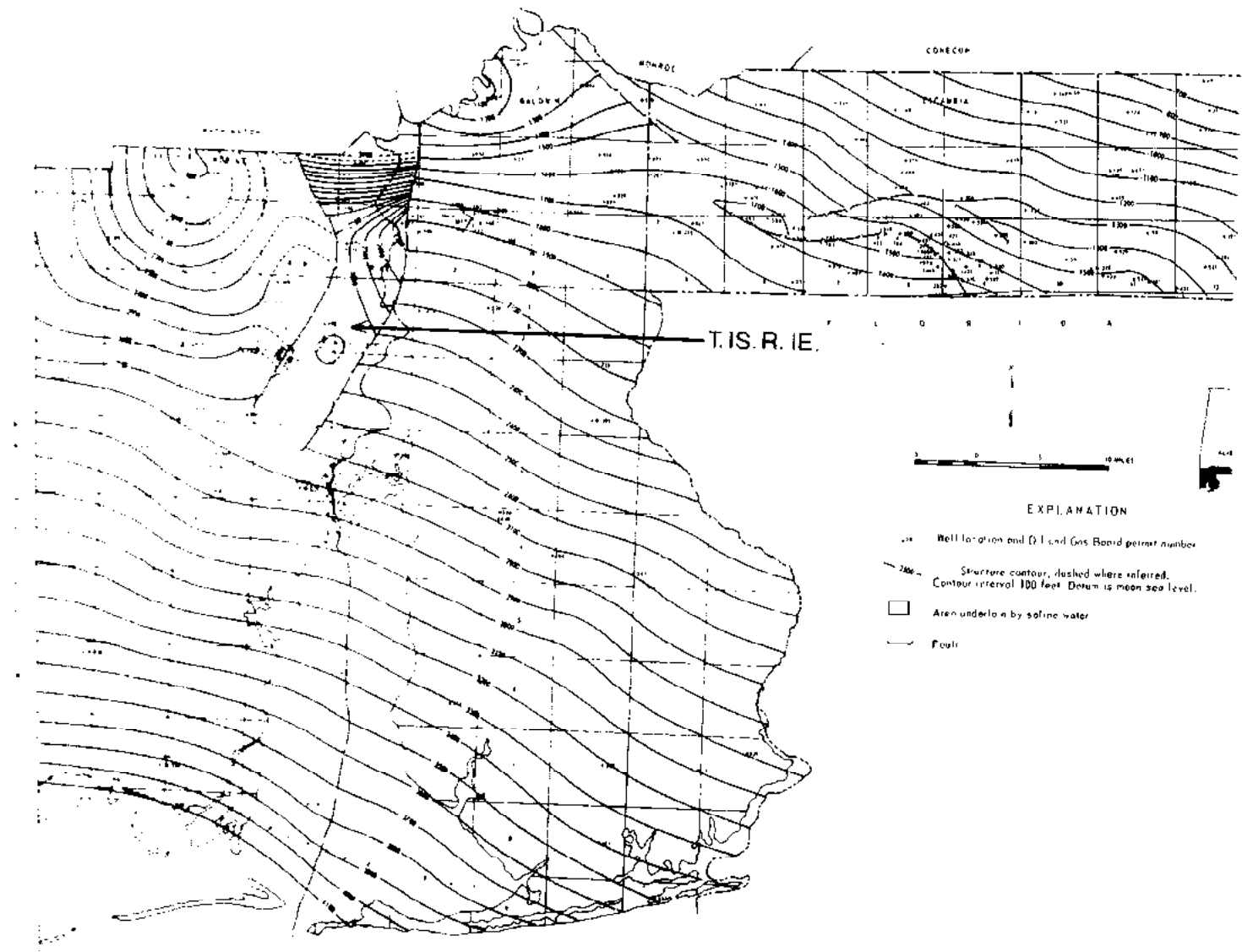

FIGURE 2-10. STRUCTURAL CONFIGURATION ON THE TOP OF THE WILCOX GROUP IN A PORTION OF SOUTH-WESTERN ALABAMA (ALVERSON, 1970).

of the Wilcox Group in southwestern Alabama. The datum for the map is sea level. A wastewater injection well present in T. 1 S., R. 1 E., is injecting into a sand bed in the Wilcox Group. It can be seen that the depth to the top of the Wilcox Group is about 2,600 feet in the center of the township (elevation of the Wilcox is about -2,600 feet and the ground elevation in that area is less than +50 feet). The general regional dip of the top of the Wilcox Group is roughly 40 feet per mile to the southwest, but the dip is steeper and more westward in the center of the township in which the well is located. It can also be seen that the well is between two major faults that enclose a downdropped block, previously identified as the Mobile graben.

## ENGINEERING PROPERTIES OF ROCKS

In order to make a quantitative evaluation of the mechanical response of the subsurface environment to wastewater injection, the engineering properties of the reservoir rocks must be determined or estimated. Properties classed here as engineering include porosity, permeability, compressibility, temperature, and state of stress. Each of these is described in detail below.

### Porosity

Porosity is defined as:

$$\phi = \frac{V_v}{V_t} \quad (\text{dimensionless}) \quad (2-1)$$

where  $\phi$  = porosity, expressed as a decimal fraction

$V_v$  = volume of voids

$V_t$  = total volume of rock sample.

Porosity is also commonly expressed as a percentage. Porosity may be a total porosity or effective porosity. Total porosity is a measure of all void space; effective porosity is based on the volume of interconnected voids. Effective porosity better defines the hydraulic properties of a rock unit, since only interconnected porosity is available to fluids flowing through the rock. The difference between total and effective porosity is often not known, or it may be small, but the distinction should be kept in mind.

Porosity may also be classified as primary or secondary. Primary porosity includes original intergranular or intercrystalline pores and the porosity associated with fossils, bedding planes, and so forth. Secondary porosity results from fractures, solution channels, and from recrystallization and dolomitization. Intergranular porosity occurs principally in unconsolidated sands and in sandstones. Intergranular porosity in a sandstone depends on the size distribution, shape, angularity, packing arrangement, mineral composition, and degree of natural cementation of the grains. It can be measured in the laboratory on consolidated rock cores taken during drilling. Core analysis of unconsolidated sands is difficult, but techniques have recently been developed by which it is possible to obtain cores from such



formations and to perform laboratory analyses upon them with some assurance that the results are representative of the in situ formation properties (Mattax and Colthier, 1974). Porosity contributed by fractures and solution channels is also difficult to measure in the laboratory. A major deficiency of core analysis is the fact that the samples being measured comprise only a small fraction of the interval of interest and may not be representative of the rock in place. To determine the porosity of strata in place, various borehole geophysical methods that will be discussed later can be used.

Porosities in sedimentary rocks range from over 35 percent in newly deposited sands to less than 5 percent in lithified sandstones. Dense limestones and dolomites may have almost no porosity. Porosity is not a direct measure of the overall reservoir quality of a rock unit, but a reservoir with high porosity is better than one with low porosity. This is because the greater the amount of pore space, the smaller will be the area into which the waste will spread. Also, although there is no universal relation between porosity and permeability, an increase in porosity often correlates with increased permeability in a particular aquifer or injection interval. Figure 2-11 is a contour map of the average porosity of the basal sandstone (Mt. Simon aquifer) in the Ohio River basin area. Average porosities range from over 20 percent to less than 5 percent. A porosity of over 20 percent is high for a lithified sandstone and a porosity of less than 5 percent is very low.

The average porosity multiplied by the total thickness of reservoir rock yields the pore volume per unit area. This number provides a means of readily comparing the storage capacity of a formation at various locations. Contour maps of pore volume have been called isoval maps. The data in Figures 2-3 and 2-11 could be combined to obtain an isoval map.

No criteria have been developed for classification of the quality of a reservoir based on its pore volume, and this may not be possible. A thick sandstone with a low porosity can have the same pore volume as a thinner sandstone with a high pore volume, yet the reservoirs will not be of equal quality for injection purposes. However, in general, a reservoir with a high pore volume will be better than a reservoir with a low pore volume.

### Permeability

The permeability of a rock is a measure of its capacity to transmit a fluid under an applied potential gradient. As with porosity, intergranular permeability is influenced by the grain properties of rocks that are composed of grains (sands, sandstones, siltstones, shales, etc.). However, whereas porosity is not theoretically dependent on grain size, permeability is strongly dependent on this property. The smaller the grains, the larger will be the surface area exposed to the flowing fluid. Since it is the frictional resistance of the surface area that lowers the flow rate, the smaller the grain size the lower the permeability. Shales, which are formed from extremely small grains, have almost no permeability. This is why shales are selected as confining intervals. As with effective porosity, permeability also results from interconnected solution channels and fractures as well as from interconnected intergranular spaces.

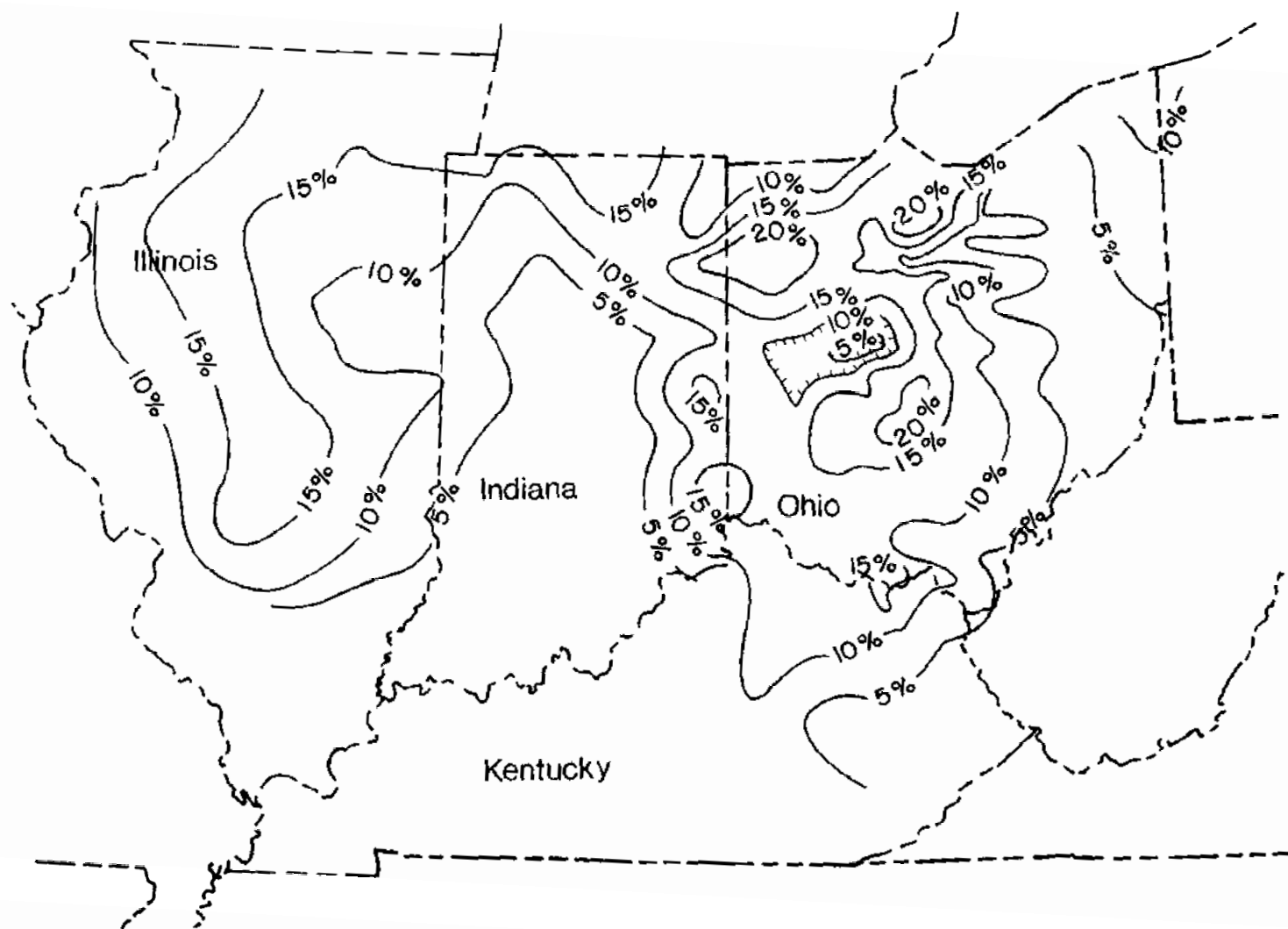

FIGURE 2-11. AVERAGE POROSITY OF THE BASAL SANDSTONE OHIO RIVER BASIN AND VICINITY (OHIO RIVER VALLEY WATER SANITATION COMMISSION 1976).

Quantitatively, permeability is expressed by Darcy's law, one form of which is:

$$\bar{K} = \frac{Q\mu}{A\rho g} \frac{dL}{dh} \quad [L^2] \quad (2-2)$$

where  $Q$  = flow rate through porous medium  
 $A$  = cross-sectional area through which flow occurs  
 $\mu$  = fluid viscosity  
 $\rho$  = fluid density  
 $L$  = length of porous medium through which flow occurs  
 $h$  = fluid head loss along  $L$   
 $g$  = acceleration of gravity  
 $\bar{K}$  = coefficient of permeability

When the properties of fluid density and viscosity appear in the Darcy equation, as in Equation 2-2, the flow capacity of the medium alone is measured and is referred to as the coefficient of permeability. If cgs units are used,  $\bar{K}$  will be expressed in  $cm^2$ . The unit of permeability used in oil-field work is the darcy or the millidarcy, which is one-thousandth of a darcy. The darcy is defined by:

$$\bar{K} = \frac{Q\mu}{A} \frac{dL}{dp} \quad [L^2] \quad (2-3)$$

where  $p = \rho gh$  = pressure and the specified conditions are:

$$1 \text{ darcy} = \frac{1 \text{ cm}^3/\text{sec} \times 1 \text{ centipoise} \times 1 \text{ cm}}{1 \text{ cm}^2 \times 1 \text{ atmosphere}}$$

A simpler form of Darcy's law used in shallow ground water studies is:

$$K = \frac{Q}{A} \frac{dL}{dh} \quad [L/T] \quad (2-4)$$

where  $K$  = hydraulic conductivity, and other symbols are as previously defined.

The density and viscosity of the aquifer fluids do not appear in Equation 2-4 because they are incorporated as part of the hydraulic conductivity value. In cgs units, hydraulic conductivity is in  $cm/sec$ . The U.S. Geological Survey unit for hydraulic conductivity is feet/day and formerly was gallons/day  $\times ft^2$  (meinzers). Because permeabilities may be found expressed in any of the units mentioned, Table 1-5 is provided to allow conversions to be made.

Permeability values from core samples of units used for wastewater injection or petroleum production range from several darcys to less than one millidarcy, but an average value of less than 10 millidarcys for an overall interval would be considered to be very low, whereas a value of 100-1,000 millidarcys would be good to very good. Shales, which are considered to be suitable confining strata, have permeabilities in the order of  $10^{-3}$  to  $10^{-6}$  millidarcys, or thousands of times less than an adequate injection interval.

In evaluating the suitability of an injection or confining unit, reservoir thickness is as important as permeability. Saturated reservoir thickness multiplied by hydraulic conductivity is the transmissivity, which can be interpreted as the rate at which fluid at the existing fluid viscosity and density is transmitted through a unit width of aquifer at a unit hydraulic gradient. The unit of transmissivity (T) is darcy-feet/centipoise or millidarcy-feet/centipoise. A suitable injection interval will usually require transmissivities measured in thousands of millidarcy-feet/centipoise. As with porosity, permeability can be measured on core samples in the laboratory or by tests performed in boreholes.

It should be mentioned that permeability may be dependent on the chemistry of the permeating fluid. Reservoirs that contain clay minerals may have a lower permeability to water than to air. The degree of permeability reduction to water as compared with air is termed the water sensitivity of a reservoir (Baptist and Sweeney, 1955). It is also important to note that the permeability of a reservoir to two or more fluids of differing capillary properties is not the same as the permeability to a single fluid as has been discussed above. When two fluids, for example, water and air or water and oil, are flowing simultaneously through a rock, the permeability to either is lower than it would be if the rock were fully saturated with the one fluid. This is one reason why oils or entrained gas should be removed from a wastewater before it is injected.

### Compressibility

The compressibility of an elastic medium is defined as:

$$\beta = \frac{-\partial V}{V \partial \rho} \quad [F/L^2]^{-1} \quad (2-5)$$

where  $\beta$  = compressibility of medium [ pressure<sup>-1</sup>]

V = volume

$\rho$  = pressure

The compressibility of an aquifer includes the compressibility of the aquifer skeleton and that of the contained fluids. (See also Compressibility, under Properties of Subsurface Fluids.) To account for the compressibility of both the fluid and the aquifer, petroleum engineers often arbitrarily use a compressibility (c), which ranges from  $5 \times 10^{-6}$  to  $10 \times 10^{-6}$  psi<sup>-1</sup> as compared with the compressibility of water alone which is about  $3 \times 10^{-6}$  psi<sup>-1</sup> (Amax, Bass, and Whiting, 1960). Van Everdingen (1968) uses this procedure

in arbitrarily selecting a fluid and rock compressibility of  $6 \times 10^{-6} \text{ psi}^{-1}$  for the example calculations that he presents.

A parameter related to compressibility is the storage coefficient, which is defined by Lohman (1972):

$$S = \phi \gamma b \left( \beta + \frac{\alpha}{\phi} \right) \quad [\text{dimensionless}] \quad (2-6)$$

where

$S$  = storage coefficient

$\phi$  = porosity

$\gamma = \rho g$  = specific weight of water per unit area or hydrostatic pressure per foot of aquifer thickness

$b$  = aquifer thickness

$\beta$  = compressibility of water

$\alpha$  = compressibility of aquifer skeleton.

The storage coefficient is the volume of water an aquifer releases or takes into storage per unit surface area per unit change in hydraulic head. Values of  $S$  are dimensionless and normally range from  $5 \times 10^{-5}$  to  $5 \times 10^{-3}$  for confined aquifers. The storage coefficient may be estimated from the equation above, or may be determined from aquifer tests that will be described.

Unfortunately, it is seldom possible to accurately calculate the storage coefficient using Equation 2-6, because the compressibility of the aquifer skeleton is only rarely known. However, Equation 2-6 is often employed to estimate a value, which is usable if no other information is available, and which can also be used to check values obtained from field tests. If the compressibility of water alone is used in Equation 2-6, then a storage coefficient will be obtained that is unreasonably low, because it does not account for any of the compressibility of the aquifer skeleton. The number does, however, serve to establish a lower limit for possible values of the storage coefficient. As discussed above, it is common practice in petroleum engineering to estimate the compressibility of subsurface reservoirs to be about two to three times that of the contained water alone. In effect, that would be equivalent to computing the storage coefficient for water alone using Equation 2-6 and then doubling or tripling the value. Such numbers might be regarded as average for deep confined aquifers. Lohman (1972) suggests that a value of  $10^{-6}$  per foot of aquifer thickness is representative of confined aquifers.

As an example, consider the storage coefficient resulting from the compressibility of water alone in a 100-foot-thick aquifer with a porosity of 0.2. From Equation 2-6,  $S = \phi \gamma b \left( \beta + \frac{\alpha}{\phi} \right) = (0.2) (62.4) (100) (10^{-6}) (1.0) = 1.24 \times 10^{-3}$ .

$10^{-6}$  psi $^{-1}$ ) =  $2.7 \times 10^{-5}$ . Since this value must be too low, it will arbitrarily be multiplied by 2.5 to obtain a more reasonable value of  $7.4 \times 10^{-5}$ . In comparison with this, Lohman's suggested value of  $10^{-6}$  per foot of aquifer thickness gives a storage coefficient of  $1 \times 10^{-4}$ . None of these procedures yields an accurate value, but they all help to determine the order of magnitude within which the storage coefficient should lie.

### Temperature

The temperature of the aquifer and its contained fluids is important because of the effect that temperature has on fluid properties. The temperature of shallow ground water is generally about 2° to 3° greater than the mean annual air temperature. Figure 2-12 shows the approximate temperature of ground water in the United States. Below the shallow ground water interval, the temperature increases at an average rate of about 2°F per 100 feet of depth, but the rate of increase is quite variable and may be from as much as 5°F to less than 1°F per 100 feet of depth (Levorsen, 1967). This rate of temperature increase with increasing depth is termed the geothermal gradient. The geothermal gradient is obtained from temperature measurements made in deep wells and is calculated by dividing the difference between the temperature at a point in the subsurface and the mean annual surface temperature by the depth to the observation point. Figure 2-13 is an example of a geothermal gradient map. Geothermal gradient maps for the United States have been prepared by the American Association of Petroleum Geologists, Tulsa, Oklahoma, and can be obtained from the organization.

Using data such as that in Figure 2-12 and 2-13, the temperature at a specific location and depth can be estimated. For example, at a site where the mean annual surface temperature is 60°F and the gradient is 1.5° per 100 feet of depth, the estimated temperature at a depth of 3,000 feet would be about 105°F.

### State of Stress

In a sedimentary rock sequence, the total normal vertical stress increases with depth of burial, under increasing thicknesses of rock and fluid. It is commonly assumed, and the validity of the assumption can easily be verified, that the normal vertical stress increases at an average of about 1 psi/ft of depth. The lateral stresses may be greater or less than the vertical stress, depending on geologic conditions. In areas where crustal rocks are being actively compressed, lateral stresses may exceed vertical ones. In areas where crustal rocks are not in active compression, lateral stresses should be less than the vertical stress. The basis of estimating lateral stress prior to drilling of a well is hydraulic fracturing data from nearby wells and/or knowledge of the tectonic state of the region in which the well is located. The tectonic state of various regions is only now being determined. For example, Kehle (1964) concluded, as a result of hydraulic fracturing data from four wells, that the stresses at the well locations in Oklahoma and Texas were representative of an area that was tectonically in a relaxed state. In contrast, Sbar and Sykes (1973) characterized much of the eastern and north-central United States as being in a state of active tectonic compression.

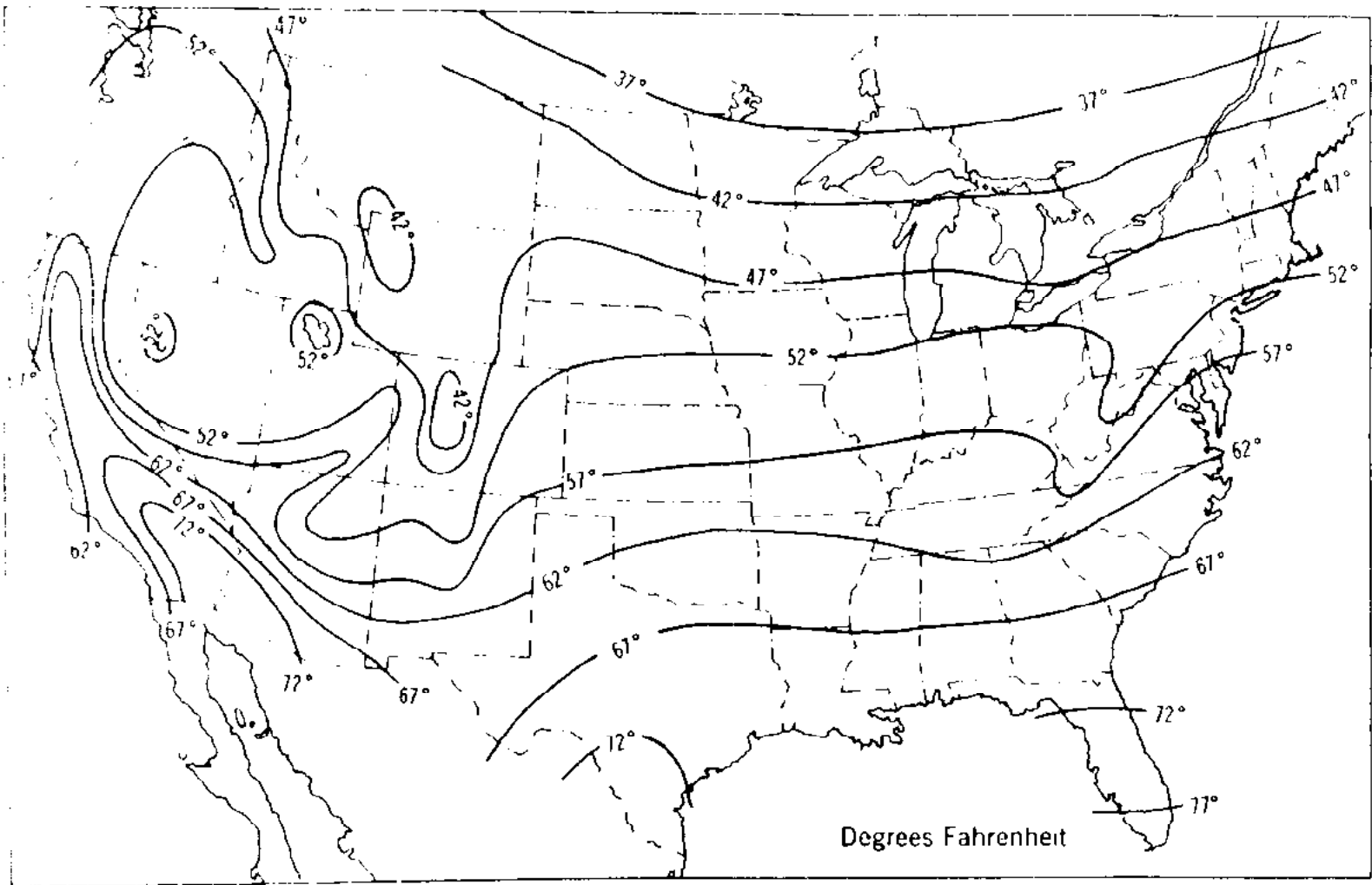

FIGURE 2-12. APPROXIMATE TEMPERATURE OF GROUND WATER IN THE UNITED STATES AT DEPTHS OF 30 TO 60 FEET (COLLINS, 1925).

# CONTOUR MAP OF GEOTHERMAL GRADIENTS IN SW. U.S.

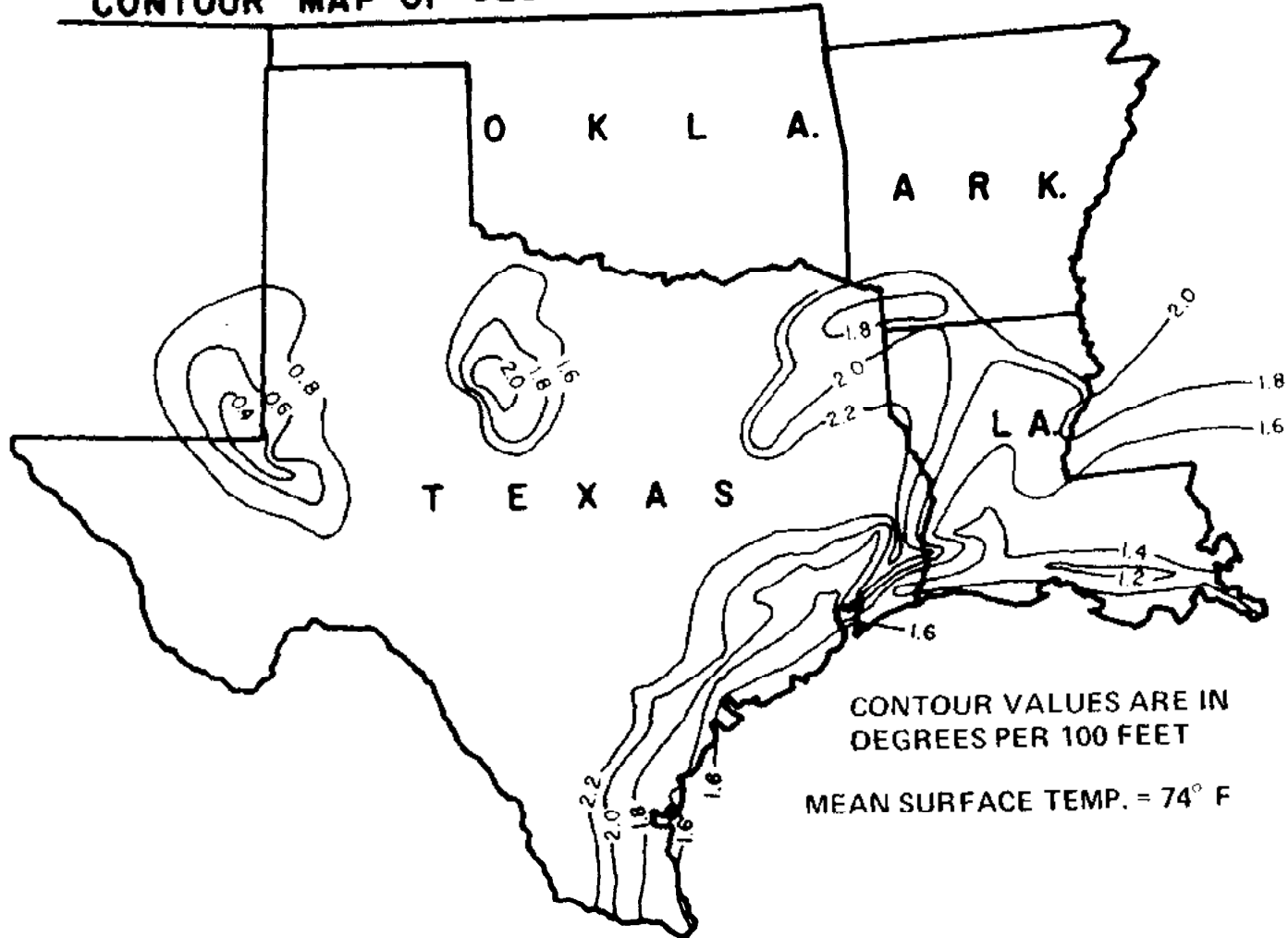

FIGURE 2-13. GEOTHERMAL GRADIENT CONTOURS IN PARTS OF TEXAS, LOUISIANA, AND ADJACENT STATES. CONTOUR VALUES ARE IN DEGREES FARENHEIT PER 100 FEET OF DEPTH (WELEX, UNDATED).



In order to predict the pressure at which hydraulic fracturing or fault movement would be expected to occur, it is necessary to estimate the state of stress at the depth of the injection horizon. On the other hand, determination of the actual fracturing pressure allows computation of the state of stress (Kehle, 1964).

The general equation for total normal stress across an arbitrary plane in a porous medium is (Hubbert and Willis, 1972):

$$S = p + \sigma \quad [F/L^2] \quad (2-7)$$

where  $S$  = total stress

$p$  = fluid pressure

$\sigma$  = effective or intergranular normal stress.

Effective stress, as defined by Equation 2-7, is the stress available to resist hydraulic fracturing or the stress across a fault plane that acts to prevent movement on that fault. The equation shows that, if total stress remains constant, an increase in fluid pressure reduces the effective stress and a decrease in fluid pressure increases effective stress. When the effective stress is reduced to zero by fluid injection, hydraulic fracturing occurs. In the presence of a fault, along which shear stress already exists, fault movement will occur before normal stresses across the fault plane are reduced to zero.

Further discussion concerning the state of stress and hydraulic fracturing will be presented in the section on hydraulic fracturing.

### Properties of Subsurface Fluids

#### Chemistry --

Judgement as to whether wastewater may or may not be permitted to be injected into a rock unit depends, in part, on the chemistry of the contained water. Chemical analyses of subsurface water are also useful for correlation of stratigraphic units, interpretation of subsurface flow systems, and calibration of borehole logs. In wastewater injection, the chemistry of contained water is important because of the possibility of reaction with injected wastewater. This latter topic is discussed in detail in Chapter 6.

In order to evaluate the chemistry of aquifer water, it is necessary to obtain samples after a well is drilled; samples from previously drilled wells may provide a good indication of what will be found. Geophysical logs are also useful for estimating the dissolved solids content of aquifer water in intervals that are not sampled. The range of dissolved ions that may be present in a subsurface water is so great that a complete chemical analysis is seldom performed. In most instances, analysis will be made for the principal ions and others on a selected basis. Table 2-1 lists the chemical and physical determinations that may be performed for the naturally occurring water in an injection interval. The routine determinations characterize the

TABLE 2-1. COMMON WATER ANALYSES PERFORMED  
ON SUBSURFACE WATER SAMPLES

DETERMINATION	ROUTINE ANALYSIS	INJECTION INTERVAL WATER
Alkalinity	X	X
Aluminum		X
Barium		X
Calcium	X	X
Chloride	X	X
Conductivity	X	X
Hydrogen ion (pH)	X	X
Hydrogen sulfide		X
Iron	X	X
Magnesium	X	X
Manganese		X
Potassium	X	X
Sodium	X	X
Specific gravity	X	X
Sulfate	X	X
Total Dissolved Solids	X	X

general geochemical nature of the water. The additional analyses suggested for an injection interval water are for the purpose of predicting the reactivity of that water with injected water. They would be selected on the basis of reactions that are suggested by the chemistry of the wastewater. Samples of water taken from shallow fresh-water aquifers should be analyzed more completely for minor elements so that their baseline quality is well established and the presence of any later-introduced contaminants can be detected.

One means of illustrating the quality of water in a subsurface reservoir is by use of a map in which the concentration of dissolved solids or another selected measurement is shown with contours (isocon map). Figure 2-14 shows the chloride concentrations of Arbuckle Formation water in Kansas and Oklahoma. The map shows that water in the Arbuckle is less saline around outcrop areas where it has been diluted by fresh water entering the outcrop. Away from the outcrop, water in the Arbuckle is very saline, which is one reason that the formation has been widely used as an injection interval in those two states.

#### Viscosity --

Viscosity is the ability of a fluid to resist flow, and is an important property in determining the rate of flow of a fluid through a porous medium. The common unit of viscosity is the poise, or the centipoise, which is one one-hundredth of a poise. Figure 2-15 shows the variation in viscosity of water with temperature and salinity. Both temperature and dissolved solids content can have a significant effect. In most cases, the effects will tend to be offsetting in subsurface waters, since temperature and dissolved solids content both commonly increase with increasing depth.

#### Density --

The density of a fluid is its mass per unit volume. Liquid density increases with increased pressure and decreases with increased temperature. However, that water changes very little within the range of pressures and temperatures of interest. For example, the density of water decreases only  $0.04 \text{ gm/cm}^3$  between  $60^\circ\text{F}$  and  $210^\circ\text{F}$  (Figure 2-16), and increases only about  $0.04 \text{ gm/cm}^3$  from 0 to 14,000 psi (Figure 2-17). A more important influence on water density is the total dissolved solids content. Figure 2-18 shows the effect of various amounts of sodium chloride on specific gravity (or density).<sup>1</sup> Since natural brines may differ significantly from sodium chloride solutions, it may be desirable to develop empirical relationships between density and dissolved solids as was done by Bond (1972) for the Illinois basin (Figure 2-19).

<sup>1</sup>Specific gravity is the ratio of the mass of a body to that of an equal volume of pure water, so for practical purposes, in the metric system, the numerical values of density and specific gravity are equal. Specific gravity, however, is dimensionless.

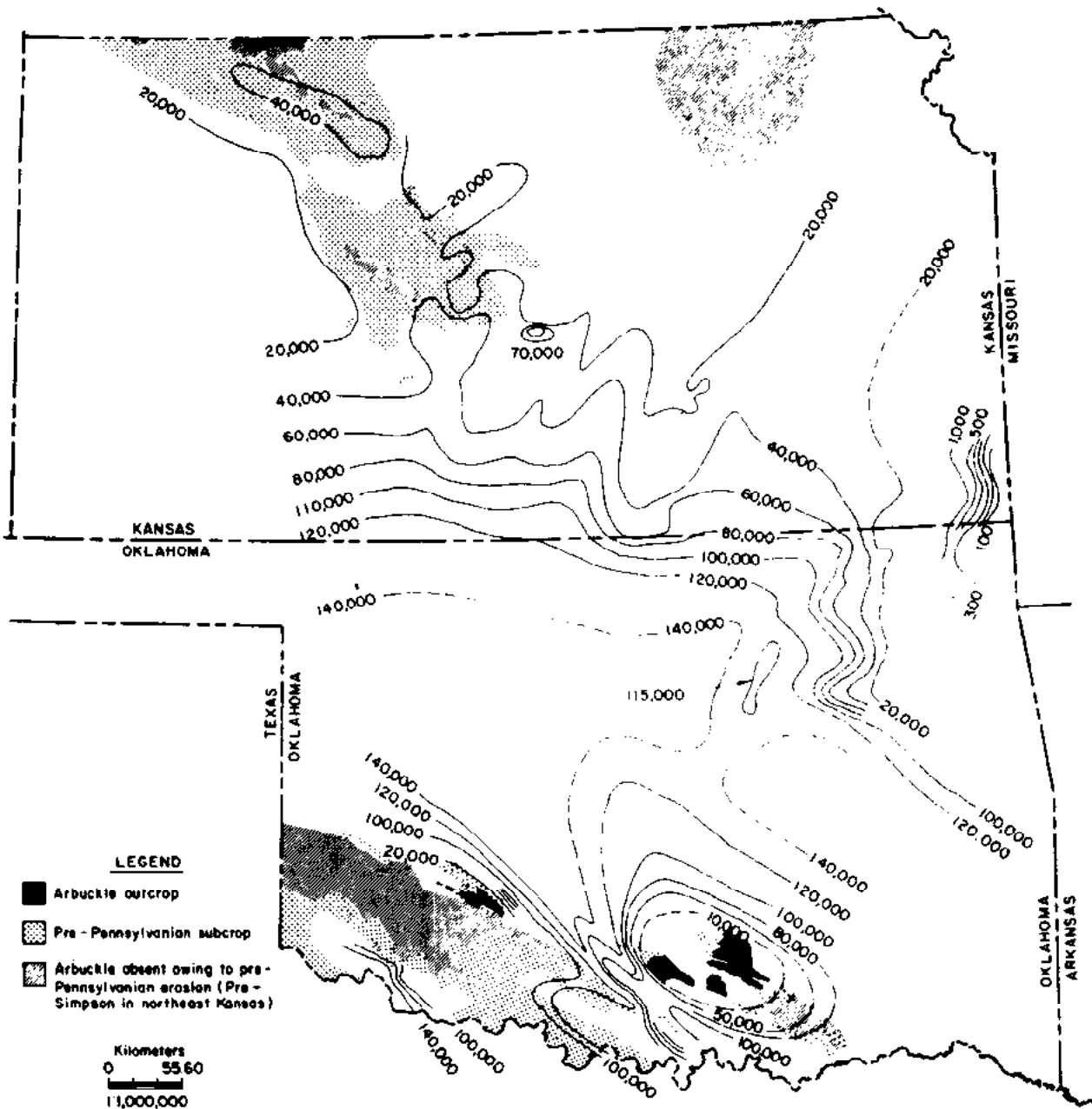

FIGURE 2-14. MAP OF THE CHLORIDE CONCENTRATIONS IN WATERS OF THE ARBUCKLE FORMATION IN KANSAS AND OKLAHOMA (COLLINS, 1975, P. 332).

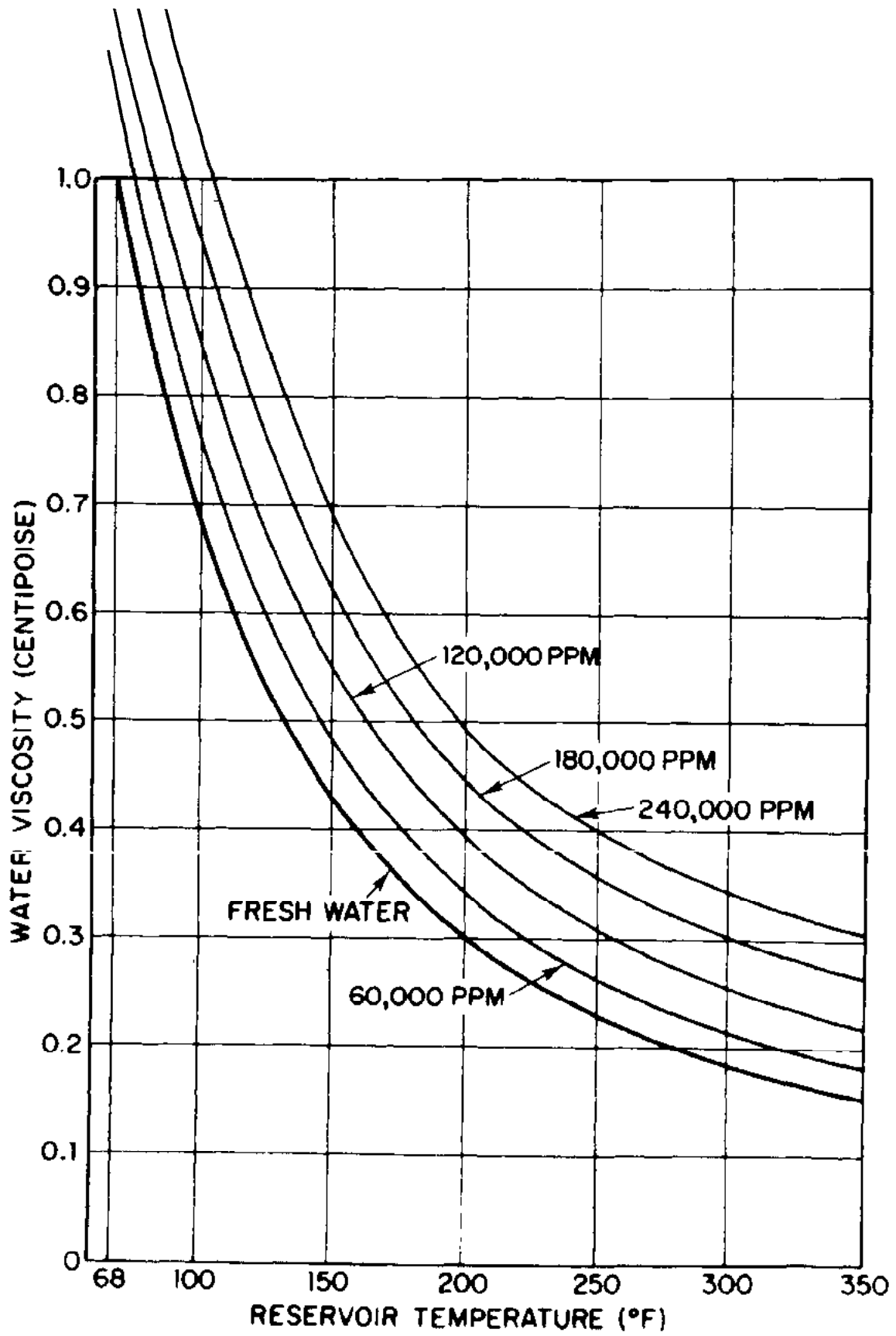

FIGURE 2-15. WATER VISCOSITY AS A FUNCTION OF TEMPERATURE AND SALINITY (see NOTE) (PIRSON, 1961, p. 50).

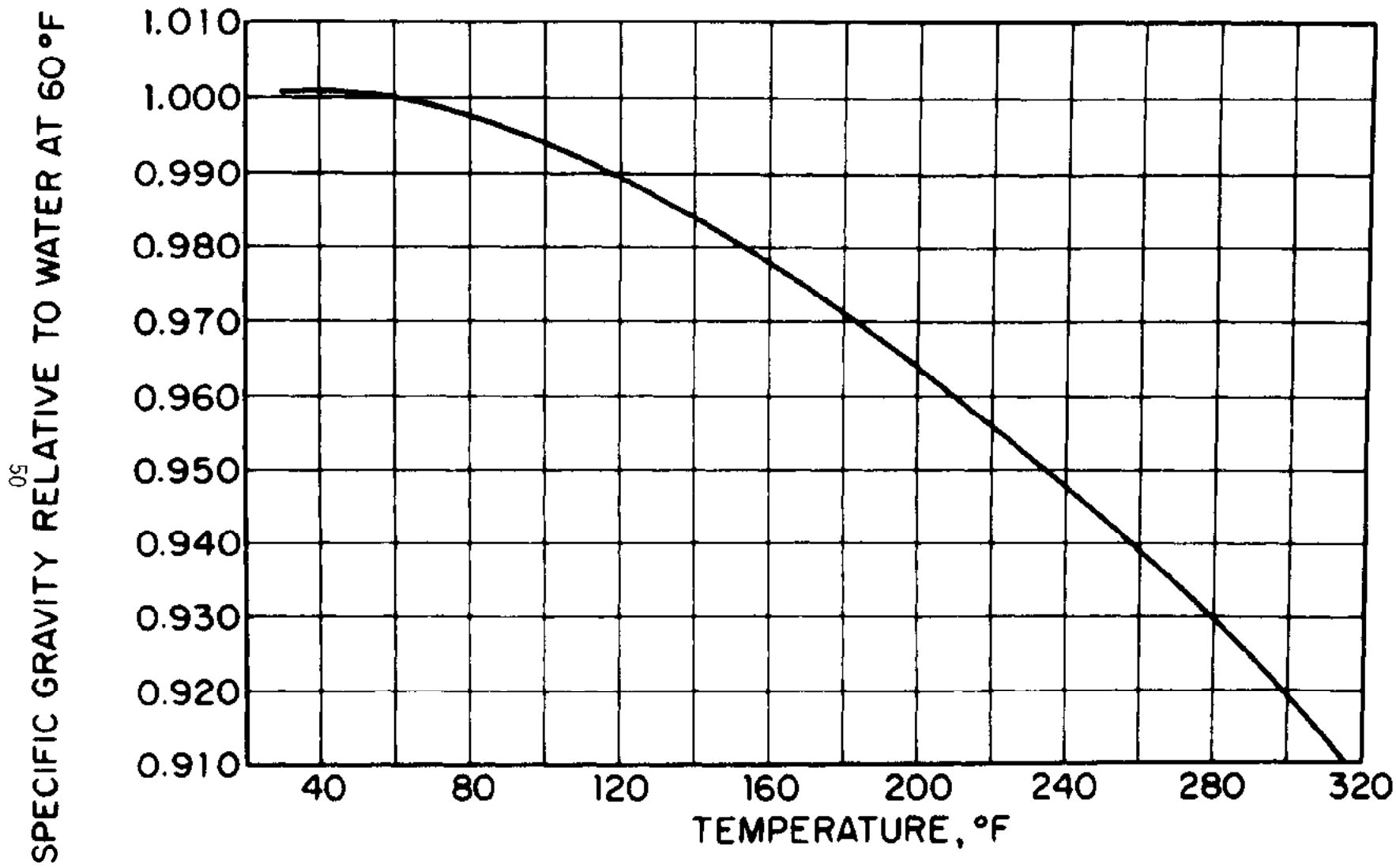

FIGURE 2-16. SPECIFIC GRAVITY OF DISTILLED WATER AS A FUNCTION OF TEMPERATURE (PIRSON, 1963, P. 39).

PROPERTIES OF LIQUID WATER

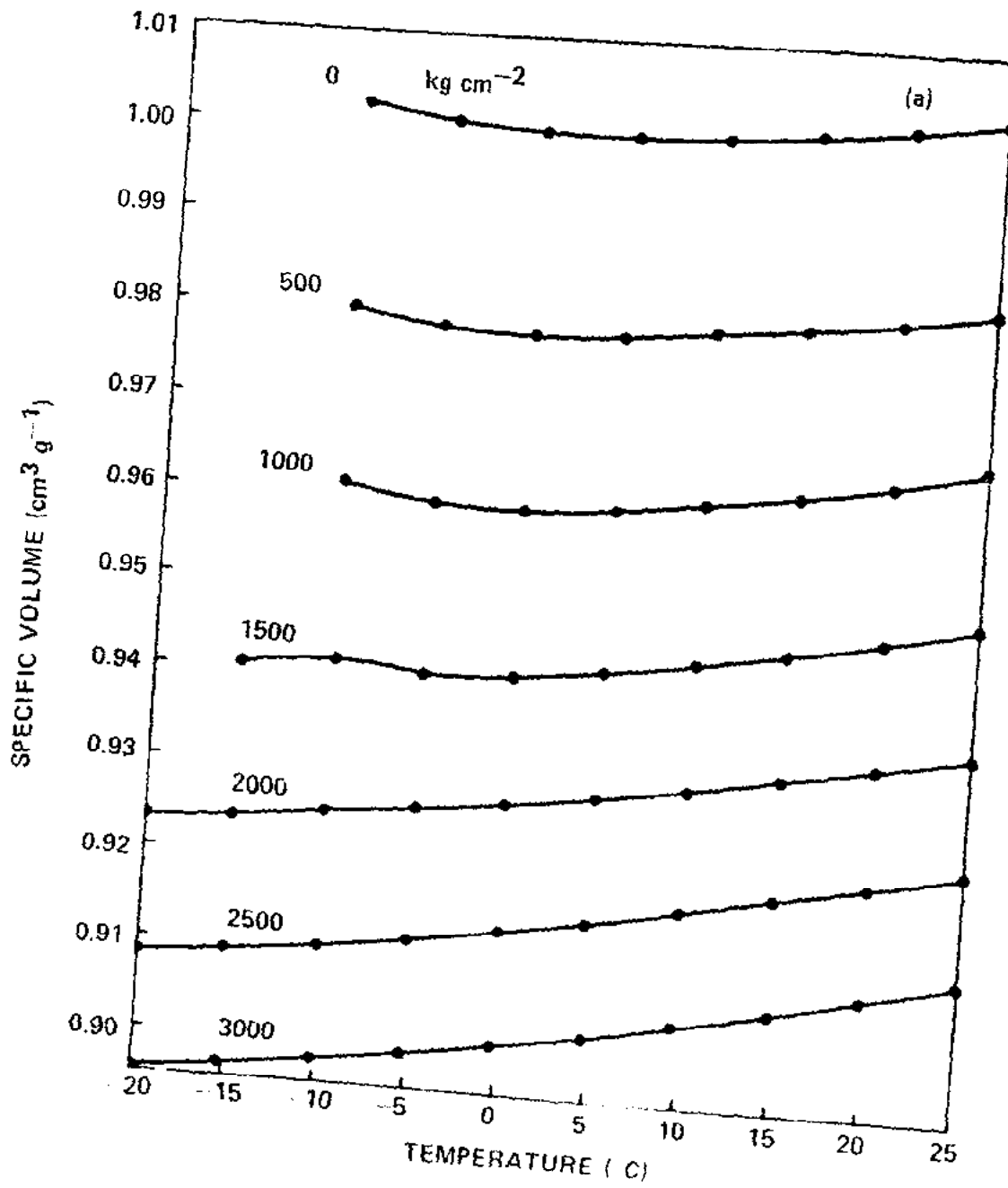

FIGURE 2-17. SPECIFIC VOLUME OF WATER AS A FUNCTION OF TEMPERATURE AND PRESSURE (EISENBERG AND KAUFMANN, 1969, P. 186).

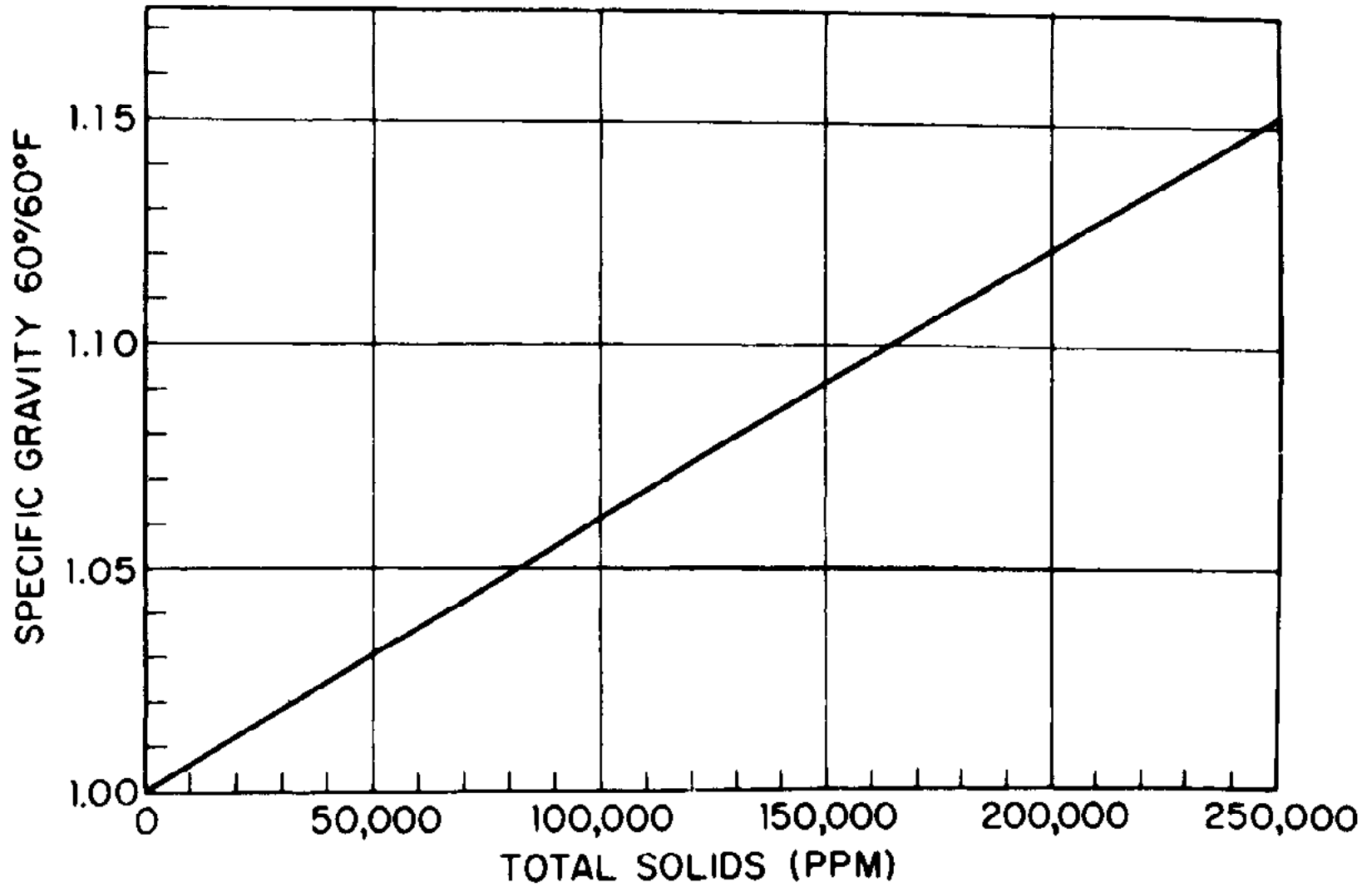
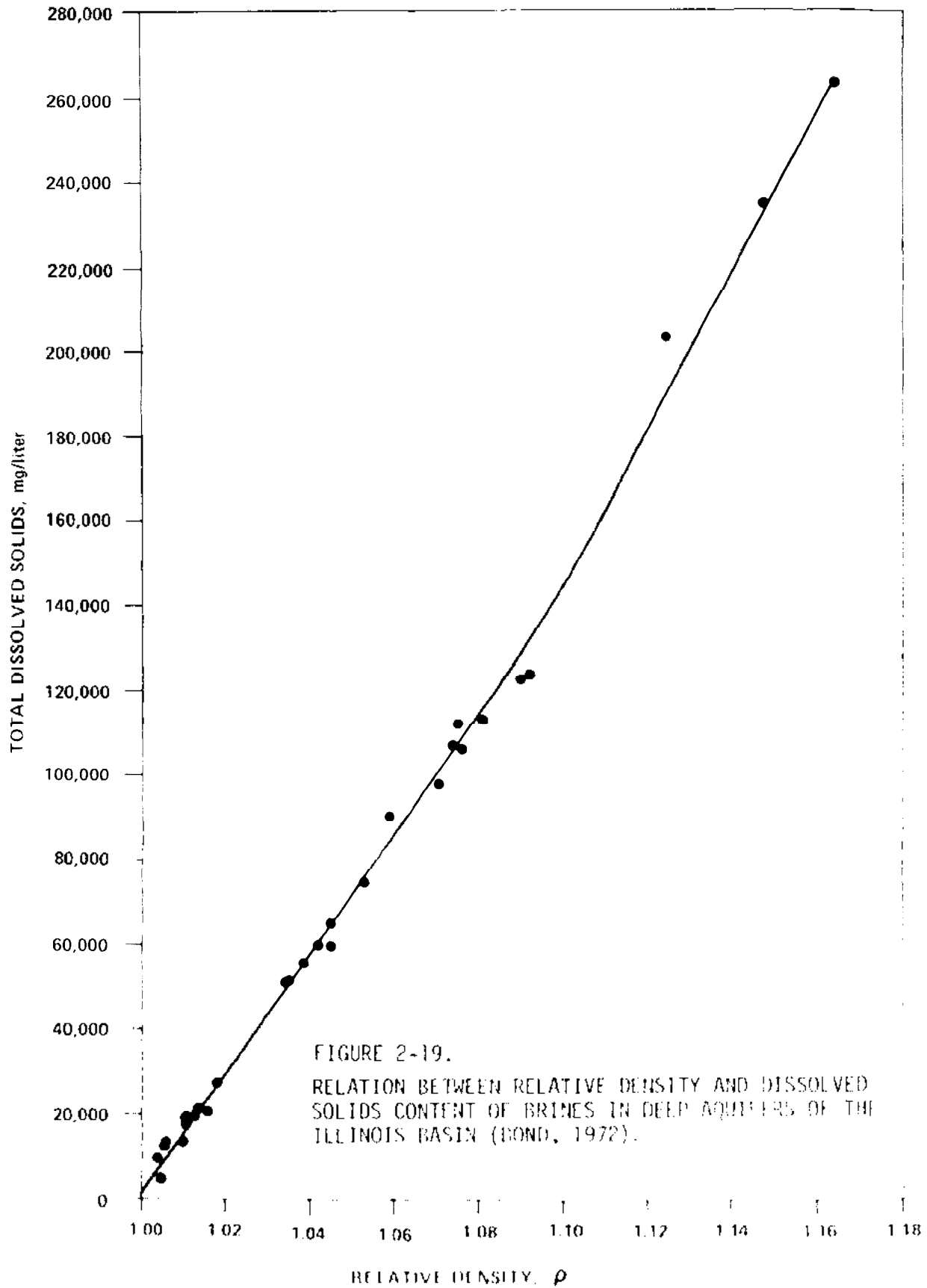

FIGURE 2-18. SPECIFIC GRAVITY OF WATERS VERSUS TOTAL SOLIDS IN ppm (DATA FOR NaCl SOLUTIONS) PIRSON, 1963, P. 39).





## Pressure --

A knowledge of fluid pressure in the unit proposed for wastewater injection is important. Fluid pressure can be measured directly in the borehole at the depth of the injection horizon, usually by performing a drill-stem test, which will be described later. Fluid pressure at the injection horizon can also be measured indirectly by determining the static water level in the borehole, then computing the pressure of the fluid column at the depth of interest.

Figure 2-20 shows how fluid pressure increases with depth in a well bore filled with fresh water having a specific gravity of 1.0. When the average specific gravity of the water or wastewater is other than 1.0 the rate of pressure increase varies accordingly. For example, if a well bore is filled with formation water with a dissolved solids content of 65,000 mg/liter and a specific gravity of 1.035, then fluid pressure increases at a rate of 0.45 psi/ft, and would be 450 psi at the bottom of a 1,000-ft-deep water-filled well. This is an average gradient (Levorsen, 1967, p. 394), but the actual gradient can vary because of water density variations and other causes and should be determined for any specific site.

Although instances of truly anomalous formation pressure are likely to be relatively rare at sites selected for wastewater injection, the existence of unusually high or low pressures and the possible reasons for their existence should be recognized.

Hanshaw and Zenn (1965) list ten possible causes of anomalous pressure as (1) high hydraulic head (2) rapid loading and compaction of sediments (3) tectonic forces (4) temperature effects (5) osmotic membrane phenomena (6) "fossil" pressure corresponding to previous greater depth of burial (7) infiltration of gas (8) mineral phase changes involving water (9) solution or precipitation of minerals (10) water from magmatic intrusions. Of these mechanisms, the first five are the most commonly mentioned. Large scale injection or extraction of fluids could also be added to the list.

Abnormally high pressures are common in deep wells of the Gulf Coast (Dickinson, 1953). Berry (1973) concluded that abnormally high pressures in the California Coast Ranges are a result of tectonic forces. Hanshaw (1972) discussed natural osmotic effects and their relation to subsurface wastewater injection.

## Compressibility --

All pore space in strata used for wastewater injection is already fluid filled and injected wastewater is emplaced by displacing and compressing aquifer water and by compressing the skeleton of the aquifer.

The compressibility of water varies both with temperature and pressure, as is shown in Figure 2-21. For problems in wastewater injection, compressibility will generally be within the range of  $2.8$  to  $3.3 \times 10^{-6}$   $\text{psi}^{-1}$ , and  $3.0 \times 10^{-6}$   $\text{psi}^{-1}$  is a reasonable value to assume in most cases.

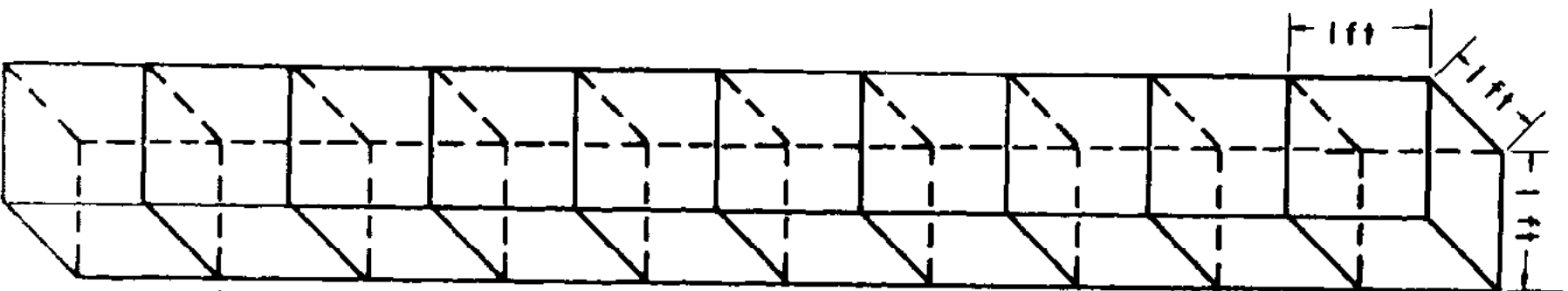

$$0.433 = \frac{62.4 \text{ lb}}{144 \text{ sq in}} \text{ OR } \text{psi/ft}$$

0.433

0.433

0.433

0.433

0.433

0.433

0.433

0.433

0.433

4.33 psi/10 feet

FIGURE 2-20.

Pressure on a horizontal surface  
 is the same at all points.  
 (62.4 lb/cu ft) (1 ft) (1 sq ft) = 62.4 lb

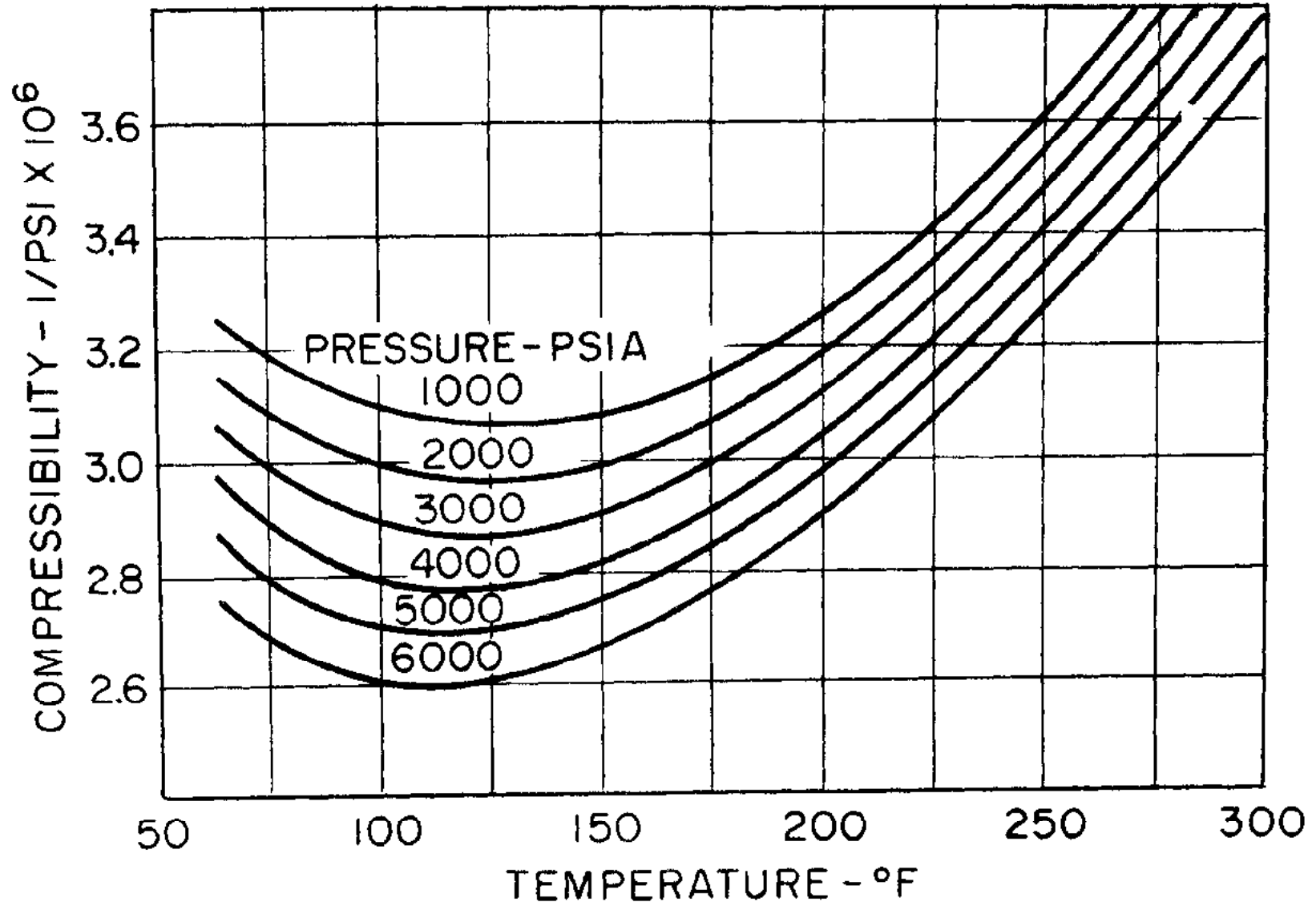

FIGURE 2-21. COMPRESSIBILITY OF WATER  
(KATZ AND COATS, 1968, P. 93).

## Subsurface Flow Systems

Understanding of the ultimate fate of injected wastewaters and their environmental effect depends, in part, on knowledge of the regional and local subsurface flow system. Earlier in the chapter it was shown that the fluid pressure in a well filled with saline water or a saturated series of sedimentary rocks increases vertically at an average of about .45 psi per foot of depth below the water surface as a result of the weight of the water alone. If the water in a subsurface reservoir were static (not moving) and had the same density everywhere, it would rise to the same level in all wells that tap the aquifer. In that case, the pressure in a horizontal aquifer would be the same everywhere. Water in some deeply buried rock units has been found to be nearly static. If the water is moving, the water levels will vary. They will be higher in wells nearest the source of flow and lower at progressively greater distances away from the source of flow, showing that hydrodynamic conditions exist. The surface formed by water levels in wells tapping an aquifer that is confined by an aquiclude or aquitard is a piezometric or potentiometric surface, which can be shown with a profile (Figure 2-22) or a contour map. The fluid potential at a point in an aquifer is defined as (Hubbert, 1953):

$$\phi = gz + \frac{p}{\rho} \quad (2-8)$$

where  $\phi$  = fluid potential

$g$  = gravitational constant

$p$  = fluid pressure

$\rho$  = fluid density

$z$  = elevation at the point of pressure measurement relative to a selected datum (usually sea level).

If both sides of Equation 2-8 are divided by  $g$ , the gravitational constant, then the fluid potential is expressed as elevation, and the basis for the validity of using measured water levels to define the potentiometric surface is shown. Equation 2-8 is necessary because pressure measurements are usually made in wells of the type used for injection rather than water level measurements, as is common in water wells. Pressure is then converted to potential in feet and added to the elevation of the measurement point to obtain total potential.

Figure 2-23 is a potentiometric map of the sequence of Ordovician age strata in the mid-continent area. The upper portion of the Arbuckle Group is included in this unit. Lines drawn perpendicular to equipotential lines indicate the direction of fluid flow, which is shown by arrows in Figure 2-23. While the significance of parts of Figure 2-23 is not certain, an important fact that can be obtained from the map as far as waste injection is concerned, is that the potential gradient is very low in Kansas and much of Oklahoma. This suggests that fluids in the Ordovician rocks are moving at low rates. The area of high gradients that appears in the Anadarko basin?

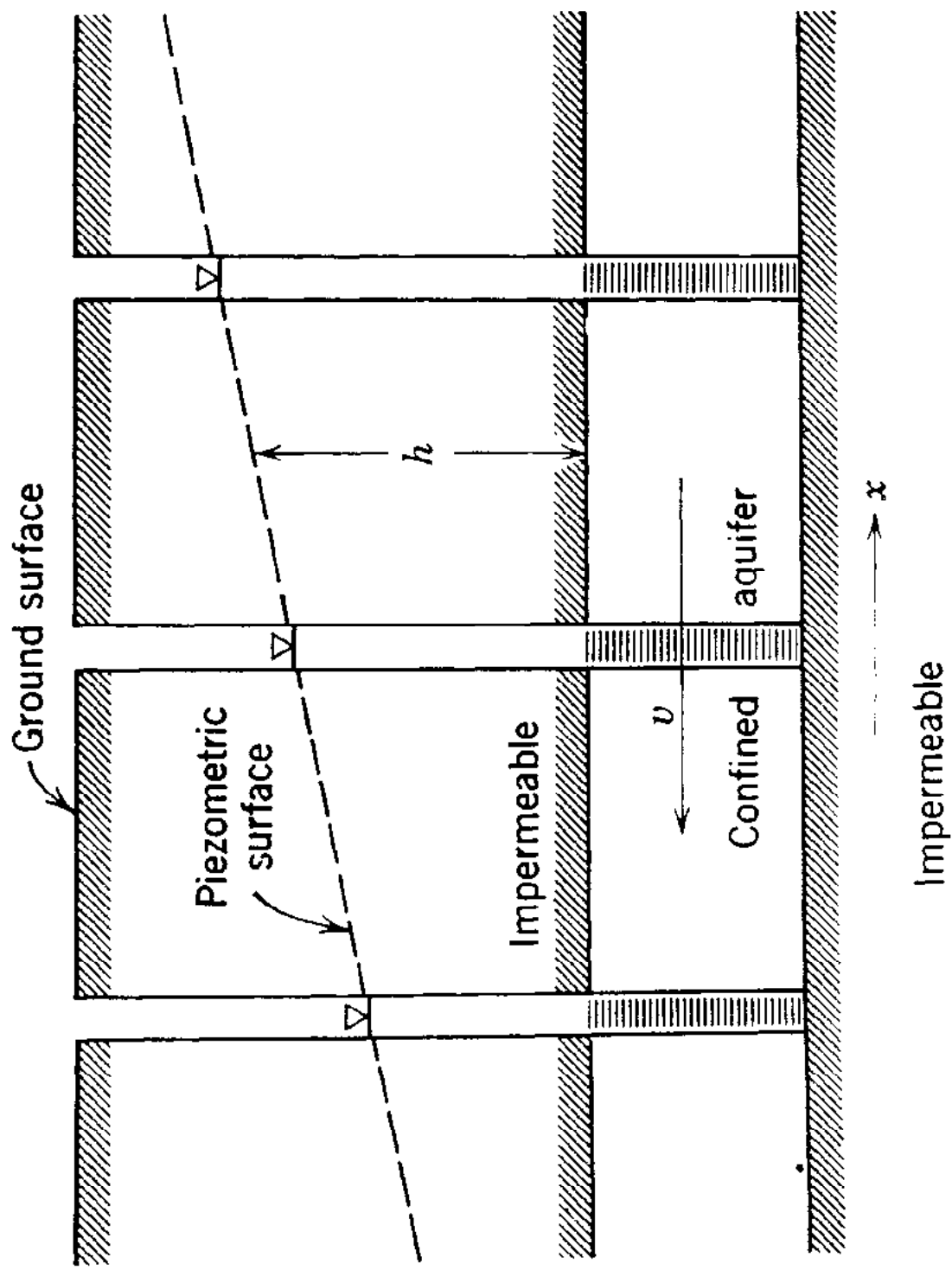

FIGURE 2-22. DIAGRAMMATIC PROFILE OF THE PIEZOMETRIC (POTENTIOMETRIC) SURFACE OF A CONFINED AQUIFER IN WHICH FLOW IS FROM RIGHT TO LEFT, AS DEFINED BY THE WATER LEVELS IN THREE WELLS (TODD, 1959, P. 79).

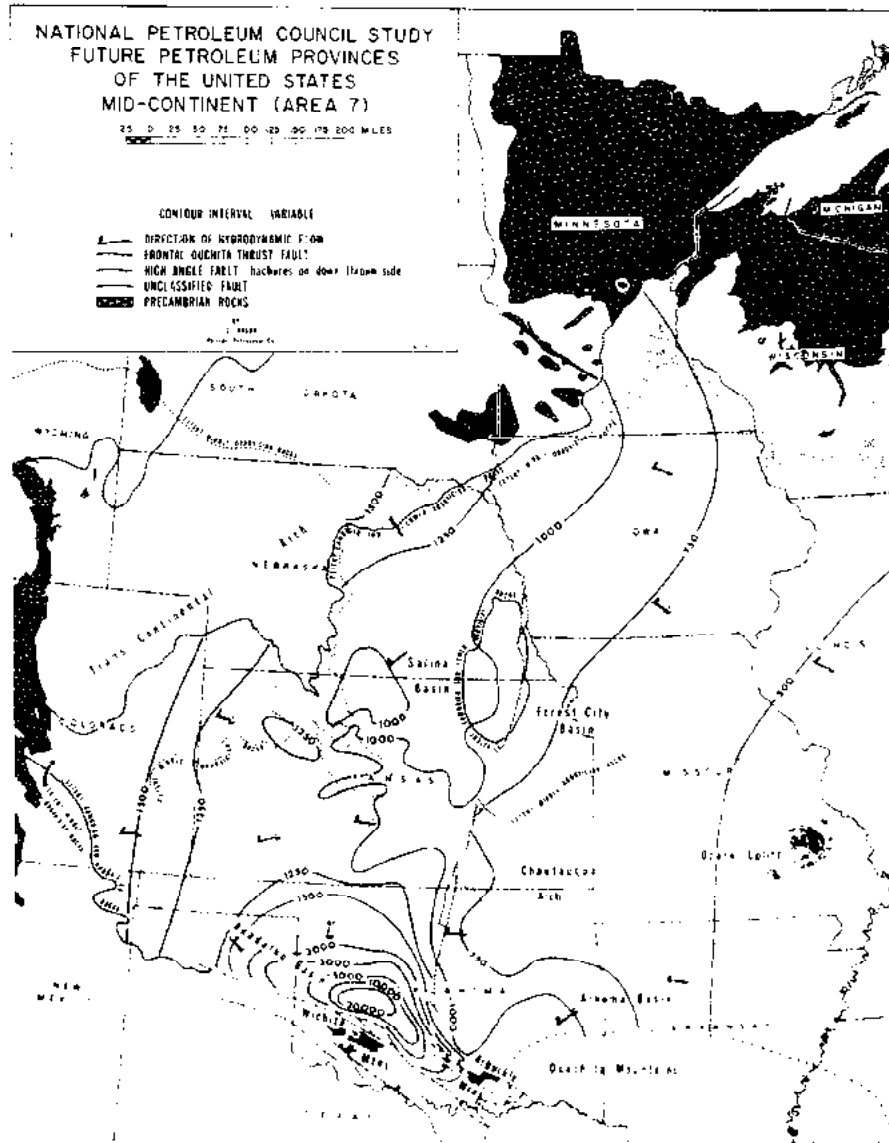

FIGURE 2-23. POTENTIOMETRIC SURFACE MAP OF ORDOVICIAN AGE ROCKS IN THE MID-CONTINENT AREA (LARSON, 1971).

not one in which wastewater injection into Ordovician rocks is likely to be practiced in any case, because of the great depth at which these rocks occur in that area. The calculation of flow rates from potentiometric maps is covered in Chapter 4.

### Subsurface Resources

It is the goal of both regulatory agencies and well operators to prevent jeopardizing fresh ground water, oil or gas, coal, and other subsurface resources. Therefore, the occurrence and distribution of all significant subsurface resources must be determined. This determination is made by reference to published reports and by consultation with public officials, companies, and individuals familiar with subsurface resources of the area. Also, the actual drilling of the well will show the location and nature of resources present in the subsurface at the well site.

In reviewing the occurrence of subsurface resources, the locations, construction, use, and ownership of all wells, both shallow and deep within the area of influence of the injection well should be determined. The plugging record for all abandoned deep wells should be obtained to verify the adequacy of such plugging. In states where oil has been produced for many years there are often areas where wells are known to have been drilled, but for which no records are available, and there are also wells which are located but for which plugging records are not available or for which plugging is known to have been inadequate. Documenting the status of deep wells near the injection well may be the most important step in site evaluation for injection wells in areas that are or have been active oil or gas provinces. These wells provide the greatest hazard for escape of wastewater or formation water from otherwise well-confined aquifers.



## CHAPTER 2

### REFERENCES

- Alverson, R. M. Deep Well Disposal Study for Baldwin, Escambia, and Mobile Counties, Alabama. Geological Survey of Alabama Circular 58, University of Alabama. 1970. 49 pp.
- Amyx, J. W., Bass, D. M., and Whiting, R. L. Petroleum Reservoir Engineering. McGraw Hill Book Co., New York. 1960. 610 pp.
- Baptist, O. C., and Sweeney, S. A. Effect of Clays on the Permeability of Reservoir Sands to Various Saline Waters. Wyoming, U.S. Bureau of Mines Rept. Inv. 5180. 1955.
- Berry, F. A. F. "High Fluid Potentials in California Coast Ranges and their Tectonic Significance." Bulletin American Association Petroleum Geologists. Vol. 57, No. 7. 1973. pp. 1219-1249.
- Bond, D. C. Hydrodynamics in Deep Aquifers of the Illinois Basin. Illinois State Geological Survey Circular 470. 1972. 72 pp.
- Buschbach, T. C. Cambrian and Ordovician Stratigraphy of Northeastern Illinois Basin. Illinois State Geological Survey Circular 470. 1972. 72 pp.
- Collins, A. G. Geochemistry of Oilfield Waters. Elsevier Publishing Co., New York. 1975.
- Collins, W. D. Temperature of Water Available for Industrial Use in the United States. U.S. Geological Survey Water-Supply Paper 520-F. 1925. pp. 97-104.
- Davis, S. M., and DeWiest, R. J. M. Hydrogeology. John Wiley and Sons, Inc., New York. 1966.
- Dickinson, George. "Geological Aspects of Abnormal Reservoir Pressures in the Gulf Coast, Louisiana." American Assoc. Petroleum Geologists Bulletin, Volume 39, No. 2. 1953. pp. 410-432.
- Eisenberg, D., and W. Kauzmann. The Structure and Properties of Water. Oxford University Press, New York, New York. 1969. 296 pp.

- Gobel, E. D. "Southeast Kansas-Northeast Oklahoma-Southwest Missouri." in Future Petroleum Provinces of the United States -- Their Geology and Potential. Ira Cram, Ed. American Assoc. Petroleum Geologists Memoir 15, Tulsa, Oklahoma. 1971. pp. 1088-1097.
- Hanshaw, B. B. "Natural Membrane Phenomena and Subsurface Waste Emplacement." in Underground Waste Management and Environmental Implications. T. D. Cook, Ed. American Assoc. of Petroleum Geologists Memoir 18, Tulsa, Oklahoma. 1972. pp. 308-315.
- Hanshaw, B. B., and Zenn, E. "Osmotic Equilibrium and Overthrust Faulting." Geol. Soc. Am. Bulletin. Vol. 76. No. 12. pp. 1379-1385.
- Hubbert, M. K. "Entrapment of Petroleum Under Hydrodynamic Conditions." Bulletin American Association Petroleum Geologists. Vol. 37. August, 1953. pp. 1954-2026.
- Hubbert, M. K., and Willis, D. G. "Mechanics of Hydraulic Fracturing." in Underground Waste Management and Environmental Implications. T. D. Cook, Ed. American Assoc. Petroleum Geologists Memoir 18. 1972. pp. 239-257.
- Jannssens, A. Stratigraphy of the Cambrian and Lower Ordovician Rocks in Ohio. Ohio Division of Geological Survey Bulletin 64. 1973.
- Katz, D. L., and D. L. Coats. Underground Storage of Fluids. Ulrich's Books, Inc., Ann Arbor, Michigan. 1968. 575 pp.
- Kehle, R. O. "The Determination of Tectonic Stresses through Analysis of Hydraulic Well Fracturing." Journal Geophys. Research. Vol. 69, No. 2. 1964. pp. 259-273.
- Larson, T. G. "Hydrodynamic Interpretation of Mid-Continent." in Future Petroleum Provinces of the United States - Their Geology and Potential. I. H. Cram, ed.. American Assoc. Petroleum Geologists Memoir 15, Tulsa, Oklahoma. pp. 1043-1048.
- Lee, Wallace, and Merriam, D. F. Cross Sections in Eastern Kansas. Kansas Geological Survey Oil and Gas Inv. No. 12. 1954.
- Levorsen, A. I. Geology of Petroleum. W. H. Freeman and Co., San Francisco. 1967.
- Lohman, S. W. Ground-Water Hydraulics. U.S. Geological Survey Prof. Paper 708. 1972. 70 pp.
- Mattax, C. C., and Clothier, A. T. "Core Analysis of Unconsolidated and Friable Sands." Society of Petroleum Engineers, SPE Paper No. 2986. October, 1974.

- Ohio River Valley Water Sanitation Commission. Evaluation of the Basal Sandstone for Wastewater Injection Ohio Valley Region. Ohio River Valley Water Sanitation Commission, Cincinnati, Ohio. 1976.
- Pirson, S. J. Handbook of Well Log Analysis. Prentice-Hall, Inc., Englewood Cliffs, N. J. 1963. 326 pp.
- Sbar, M. L., and Sykes, M. L. "Contemporary Compressive Stress and Seismicity in Eastern North America: An Example of Intra-Plate Tectonics." Geol. Soc. of Am. Bulletin. Vol. 84, No. 6. 1973. pp. 1861-1882.
- Todd, D. K. Ground Water Hydrology. John Wiley, New York. 1959.
- Tucker, W. E., and Kidd, R. E. Deep-Well Disposal in Alabama. Geological Survey of Alabama Bulletin 104. 1973.
- Van Everdingen, A. F. "Fluid Mechanics of Deep-Well Disposals." in Subsurface Disposal in Geologic Basins - A Study of Reservoir Strata. J. E. Galley, ed. American Assoc. Petroleum Geologists Memoir 10. 1968. pp. 32-42.
- Walton, W. C. Groundwater Resource Evaluation. McGraw-Hill Book Company, New York. 1970.
- Welex. Basic Concepts of Well Log Interpretation. Welex, Houston, Texas. undated. 35 pp.

## CHAPTER 3

### ACQUISITION AND USE OF GEOLOGIC AND HYDROLOGIC DATA FOR INJECTION WELL SITE EVALUATION

In order to predict the performance of injection wells and their effects on the environment, the types of information described in Chapter 2 must be estimated prior to well construction, and the actual geologic characteristics and values for rock and fluid properties determined during well construction and testing.

After the geologic and engineering data are obtained, they may be evaluated qualitatively by experienced technicians or they may be used in calculations to predict the probable performance of a well constructed at the site. Examples of such calculations are given in the latter part of the chapter.

#### DATA OBTAINABLE FROM EXISTING SOURCES PRIOR TO DRILLING

Prior to drilling an injection well, the geologic and engineering data needed for site evaluation are obtained from sources such as are shown in the figures and tables presented in Chapter 2. The information in those figures and tables has, of course, come from geological surveys, geophysical surveys, previously drilled wells, etc.; if it has not been compiled in usable form on maps, cross sections, tables, etc., then this may be necessary. Basic information for previously drilled wells is available in most states through state geological surveys, state oil and gas agencies, state water resources agencies, and some universities. States with notable oil and gas production are particularly good sources. In addition, private companies in the petroleum industry acquire and sell well logs, other subsurface data, and services. In some cases it may be feasible to go to individual oil companies or consultants for subsurface data that are not publicly available. Companies and individuals are usually cooperative in releasing information that is not considered confidential.

It is possible to obtain considerable original subsurface geological information without drilling by the use of surface geophysical methods, including seismic, gravity, magnetic, and electrical surveys. However, because of the nature of the data that can be obtained and its cost, it can be anticipated that surface geophysical surveys will not be widely used for injection well site studies. For this reason surface geophysical methods will not be discussed further here. A popular introductory text that describes the available geophysical survey methods has been written by Dobrin (1976).

## DATA OBTAINABLE DURING WELL CONSTRUCTION AND TESTING

### Rock Samples

Most deep wells drilled today are drilled by rotary drilling rigs. Rotary drilling rigs use two basic types of drilling bits: rock bits and core bits.

Rock bits grind the strata into small chips (commonly 1/8 in. - 1/2 in. across) that are usually carried from the hole by a viscous drilling mud, but sometimes by water or air. The chips are periodically collected, usually after each five or ten feet of new hole, washed, and examined with a low-power, binocular microscope. The methods for collection, examination, and description of such samples are presented in a reference edited by Haun and LeRoy (1958). Soft, unconsolidated clays will not yield chips, but will break down into mud while unconsolidated or soft sandstones will break down into individual grains when drilled. Samples are of only small value when drilling such rocks. Table 3-1 is the lithologic description of cuttings from one depth interval obtained during the drilling of an injection well in Alabama. The sampling interval in this case was 30 feet.

Core bits are open in the center so that, as the bit moves downward, a cylindrical plug of rock is cut and remains. This plug rises inside a hollow tube or core barrel in which it is held and raised to the surface. Cores from wells of the type under discussion range in size from about 1 to 5 inches, but the most common diameter is 3 1/2 inches. The length of interval that can be cored at one time depends on the length of the core barrel, which ranges from 20 to 90 feet. Cores are usually taken only from intervals of interest for injection or confinement because coring is generally much more expensive than drilling with a rock bit.

Cores are taken because they yield geologic and engineering information not otherwise available. Fractures, bedding features, solution cavities and other characteristics can be seen, and laboratory measurements of porosity, permeability, and other engineering properties can be made. Figures 3-1a to 3-1c show some of the geologic features visible in cores. Figure 3-2 is a photograph of a piece of whole core (3 1/2 in. diameter) from a sandstone reservoir. Vertical and horizontal plugs (1 in. diameter) have been cut from the core for porosity and permeability analysis. Plugs are taken as often as every foot to obtain accurate average values for the entire core. Sometimes pieces of whole core are tested, particularly in the case of limestones with solution channels or confining beds with very low permeability. Procedures for core handling and analysis have been recommended by the American Petroleum Institute (1960). Geological descriptions of cores are prepared similarly to those for cuttings, but since a continuous sample of the formation is available, much more detail can be included. Table 3-2 shows typical laboratory data obtained from a 30-foot core taken from the Mt. Simon Formation in Illinois.

Formations of unconsolidated sand or soft shale are difficult to core with rotary drilling equipment. In formations of this type, sidewall cores can be taken by a device carrying hollow cylindrical bullets that are forced

TABLE 3-1. EXAMPLE OF DESCRIPTIONS OF DRILLING CUTTINGS OBTAINED FROM ABOVE AND AT THE TOP OF THE WILCOX GROUP IN A WASTE INJECTION WELL IN ALABAMA (TUCKER AND KIDD, 1973).

Stauffer Chemical Company D.W. #1  
 SW 1/4 sec. 7, T. 1 S., R. 1 E.  
 (N along W line 2056.3 ft then E 868.2 ft)  
 Mobile County, Alabama

GSA #3374  
 Elev. 29.9 ft. GL  
 41.4 ft. DF

Samples collected at 10-foot intervals beginning at 40 feet, changing to 30-foot intervals at 70 feet.

2,440-2,470-Ctgs: Claystone, light-bluish-gray and some light olive-gray and very light yellowish gray, siliceous, glauconitic, micaceous, trace pyrite, microfossils; shale, light-olive-gray and light-greenish-gray; sand, colorless to pale-yellowish-orange, fine to very coarse, subangular to rounded, quartzose, glauconitic; limestone, brownish-gray, indurated, sandy, quartzose, glauconitic; trace lignite, trace pyrite; abundant Foram fragments from above; other lime from above; shell fragments.

2,470-2,500-Ctgs: Same with increase in greenish-gray shale, sandy, micaceous, glauconitic; also increase in brown limestone and shell fragments.

Wilcox Group?-Sample top

2,500-2,530-Ctgs: Sandstone, light-olive-gray, calcareous cement, very fine to medium grained, predominantly fine, quartzose, glauconitic; sandy limestone, yellowish-gray, fine-grained, quartzose, glauconitic; shale, greenish-gray to light-olive-gray, sandy, micaceous, calcareous in part; sand, colorless to very light gray, very fine to medium, fine predominant, subangular to rounded, quartzose, glauconitic, micaceous; limestone, brownish-gray, indurated, sandy, quartzose, glauconitic; shell fragments, Foram fragments; trace pyrite.

2,500-2,530-Ctgs: Same; predominantly sandstone and sandy limestone with some sandy shale.



FIGURE 3-1. PHOTOGRAPHS OF CORES  
(a) FRACTURES, SOLUTION CHANNELS, AND VUGS IN DOLOMITE.

(b) FOSSILIFEROUS LIMESTONE.



FIGURE 3-1. PHOTOGRAPH OF CORE

(c) LIMESTONE WITH REPLACEMENT OF FOSSILS AND FILLING OF FRACTURES BY CALCITE CRYSTALS.





FIGURE 3-2. WHOLE CORE OF MT. SIMON SANDSTONE FROM WHICH VERTICAL AND HORIZONTAL PLUGS HAVE BEEN CUT.

TABLE 3-2. LABORATORY CORE ANALYSIS DATA FROM THE  
MT. SIMON FORMATION IN ILLINOIS<sup>a</sup>

Sample Number	Depth (feet)	Permeability (millidarcys)		Porosity (percent)
		Horizontal	Vertical	
408	3154.5	6.9	0.11	6.4
409	3155.5	<0.10	0.17	6.4
410	3156.6	<0.10	<0.10	9.7
411	3157.5	0.17	0.31	8.6
412	3158.5	0.26	0.72	8.3
413	3159.5	<0.10	<0.10	8.1
414	3160.5	1.9	0.12	9.6
415	3161.5	<0.10	<0.10	8.7
416	3162.5	2.3	0.98	8.1
417	3163.5	0.43	0.46	6.2
418	3164.5	12.	0.12	8.2
419	3165.5	3.1	1.1	14.7
420	3166.5	0.31	0.44	10.7
421	3167.5	7.8	0.79	10.0
422	3168.5	8.5	5.4	9.9
423	3169.5	5.0	3.2	7.2
424	3170.5	6.2	3.6	6.9
425	3171.5	3.4	1.2	8.3
426	3172.5	10.	2.5	12.2
427	3173.5	7.4	0.46	8.9
428	3174.5	11.	2.0	8.0
429	3175.5	8.5	1.5	8.2
430	3176.5	2.6	0.91	7.7
431	3177.5	0.74	<0.10	5.9

Note:

<sup>a</sup>Mt. Simon Core No. 15 3148.0 - 3178.0

into the borehole on a cable. When the sidewall sampler is in position, the bullets are fired into the borehole walls. The bullet and its contained sample remain attached to the sampler by two heavy wires and are retrieved by pulling the bullet from the borehole wall. The samples are normally 7/8 in. to 1 3/4 in. in diameter and 1 in. to 1 3/4 in. long. Up to 30 samples can be taken by a single gun. Samples can also be taken in hard formations by this type of sidewall device, but better results have been obtained by using a sidewall diamond core slicer that cuts a triangular core one inch in depth and three feet long. Sidewall cores can be taken when it is desired to sample intervals not cored during drilling.

### Formation Fluid Samples

Samples of water from subsurface formations can be obtained from deep wells, before they are completed, by use of formation testing devices, by swabbing, and by gaslift. At times formation pressures will bring water to the surface from artesian aquifers.

Drill-stem testing is a technique whereby a zone in an open borehole is isolated by an expandable packer or packers and fluid from the formation allowed to flow through a valve into the drill pipe. See the section on Drill-Stem Testing on Page 89.

The basic drill-stem test tool assembly is normally attached to the lower part of a string of drill pipe and consists of:

1. A rubber packing element or packer which can be expanded against the hole to segregate the annular sections above and below the element.
2. A tester valve to (a) control flow into the drill pipe, that is, to exclude mud during entry into the hole and (b) to allow formation fluids to enter during the test; an equalizing or bypass valve to allow pressure equalization across the packer(s) after completion of the flow test; and pressure recording equipment.

Figure 3-3 illustrates the procedure for testing the bottom section of a hole. While going in the hole, the packer is collapsed, allowing the displaced mud to rise as shown by the arrows (a). After the pipe reaches bottom and the necessary surface preparations have been made, the packer is set (compressed and expanded); this isolates the lower zone from the rest of the open hole (b). The compressive load is furnished by slacking off the desired amount of drill string weight, which is transferred to the anchor pipe below the packer.

The tester valve is then opened and the isolated section is exposed to the low pressure inside the empty, or nearly empty, drill pipe. Formation fluids can then enter the pipe, as shown in the second picture (b). The time during which fluids are entering the drill stem testing tool is called the flow period. After the flow period, the closed-in pressure valve is shut and the formation pressure allowed to build back up (c). In a final condition

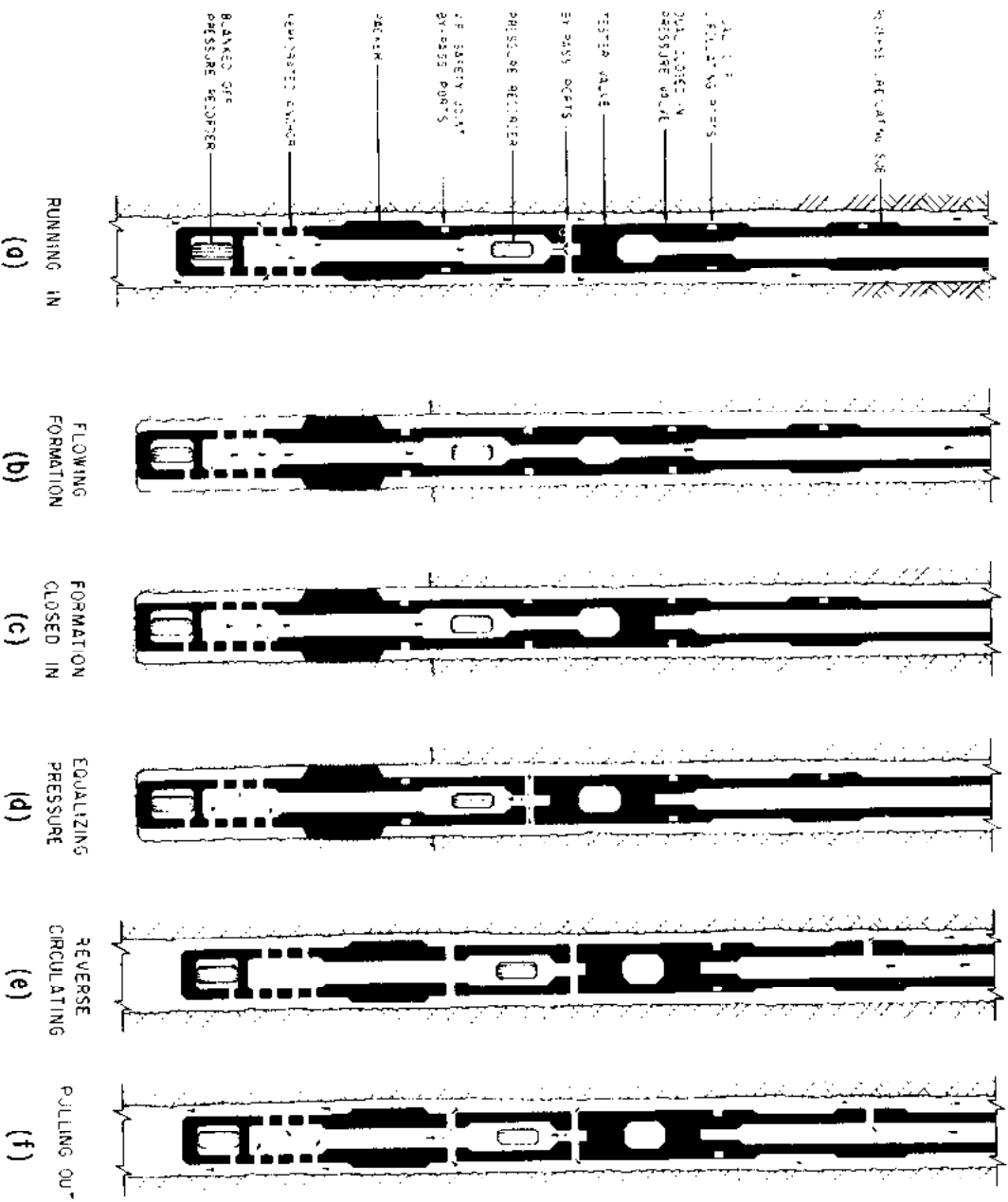

FIGURE 3-3. FLUID PASSAGE DIAGRAM FOR A CONVENTIONAL OPEN-HOLE, SINGLE-PACKER, DRILL-STEM TEST (EDWARDS AND WINN, 1974).

pressure test, the flow period and closed-in period are repeated. After the final closed-in period, the tester valve is closed in order to trap any fluid above it, and the bypass valve is opened to equalize the pressure across the packer (d). Finally, the setting weight is taken off and the packer is pulled free. The fluid in the drill pipe may then be circulated out to the surface as shown in (e), or the reverse circulating step may be bypassed and the pipe pulled from the hole until the fluid-containing section reaches the surface (f). As each successive pipe section is removed, its fluid content may be examined.

Although the test described above is a common type, there are variations of this procedure, two of which are shown in Figure 3-4. The straddle packer test is necessary when isolation from formations both above and below the test zone is necessary. Such a situation commonly arises when it is desired to test a zone previously passed by. The second common variation utilizes perforations in casing (Figure 3-4).

Tests through perforations are necessary when it is desired to check a zone that has been cased-off without testing or in order to retest a zone after casing has been emplaced.

Formation testing devices are also available which can be lowered into the borehole on a wire line rather than on a drill pipe. In this case, the sample is limited to the amount that can be contained in the testing device (up to about 5 gallons).

Swabbing is a method of producing fluid similar to pumping a well. In swabbing, fluid is lifted from the borehole through drill pipe, casing, or tubing by a swab that falls freely downward through the pipe and its contained fluid, but which seats against the pipe walls on the up-stroke, drawing a volume of fluid above it as it is raised. Swabbing is preferable to drill-stem testing where unconsolidated formations cause testing to be difficult. Swabbing may also be used in conjunction with drill-stem testing to increase the volume of fluid obtained. The advantage of swabbing is that it can be continued until all drilling mud has been drawn from the pipe, thus allowing the chemistry of the formation water sampled to reach a steady state. This procedure helps to insure that a representative sample of formation water is obtained.

Fluid samples can be obtained by injecting gas under pressure into a well. The pressure of gas forces the fluids in the well to rise to the surface, thus the name gas-lift sampling.

### Well Logs

Individuals have different concepts of what is meant by a borehole or well log, because of the variety of types of logs that are used. It is probably best to consider a log as any tabular record or graphical portrayal of drilling conditions or subsurface features observed in a borehole. This is consistent with the Glossary of Geology (American Geological Institute, 1976) in which one accepted definition of a log is "the record of formations penetrated, drilling progress, record of depth of water, oil, gas, or other minerals, the record of size and length of pipe used, and other written or recorded facts having to do with drilling a well."

## GENERAL PROCEDURE

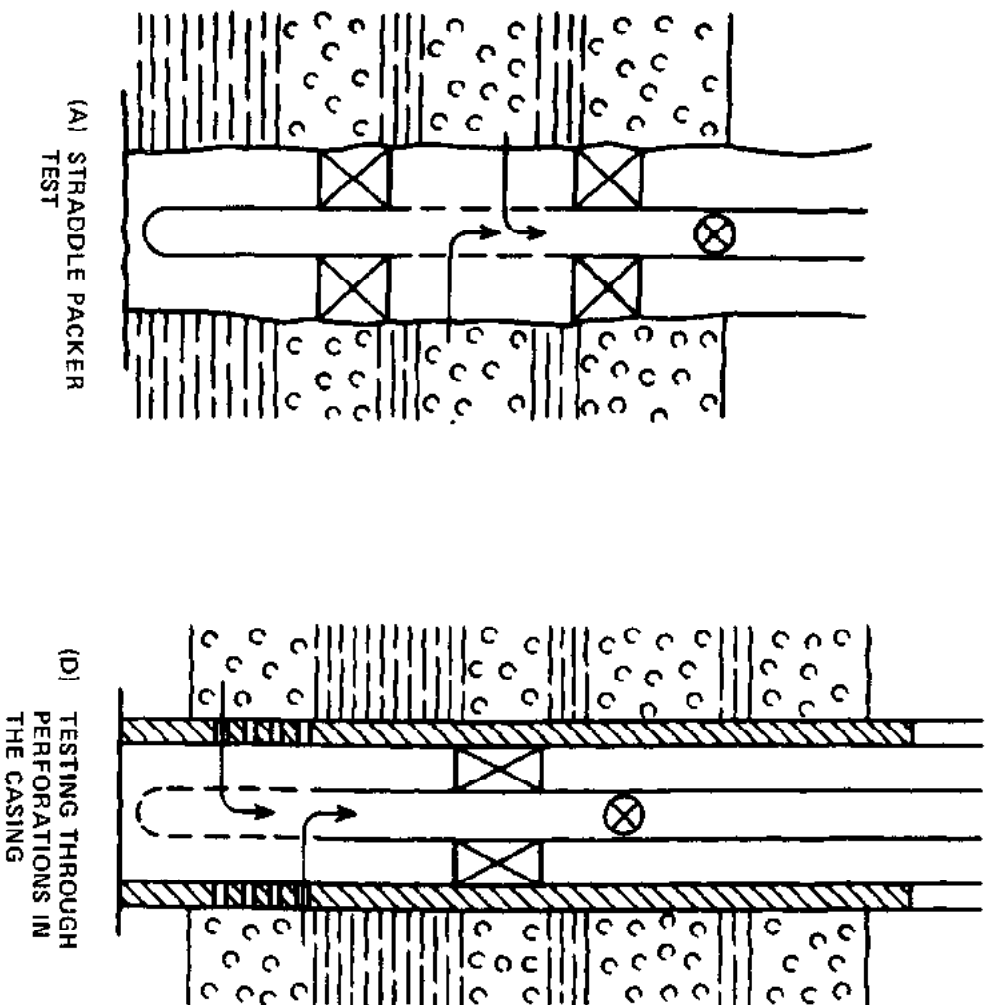

FIGURE 3-4. SCHEMATIC ILLUSTRATION OF TWO DRILL-STEM TEST CONDITIONS (MODIFIED AFTER KIRKPATRICK, 1954).

One possible classification of the general types of logs would be:

1. Sample (cuttings and core) logs
2. Driller's logs
3. Drilling time logs
4. Mud logs
5. Geophysical logs
  - A. Electrical logs
  - B. Elastic wave logs
  - C. Radiation logs
  - D. Other
6. Miscellaneous logs
  - A. Caliper logs
  - B. Dipmeter logs
  - C. Deviation logs
  - D. Production-injection logs

#### Sample Logs --

Sample logs are prepared from rock cuttings and cores as discussed above. The tabulated descriptions themselves form a log and they are often used to prepare a visual strip log or columnar section as shown in Figure 2-1.

#### Driller's Logs --

In the early days of drilling, the driller's log was the principal well record kept. It recorded the types of formations encountered, any pertinent fluid flows or oil and gas shows observed, and other related operational remarks. While these records appear crude by present standards, they were considered to be very informative at the time. Such logs are still frequently encountered as the only available source of data in old areas. The geologic descriptions of various formations may be quite colorful and full of expressions unique to either or both the particular area and driller involved.

The current rotary driller's log is filled out daily by each driller as a record of the operations, materials used, and progress which occurred during his working hours (tour). It is largely used to inform office personnel of daily occurrences, to provide operational data, and to serve as a legal record of the contractor's compliance with the operator's instructions as set forth in their agreement or contract. The hourly breakdown of time spent on various operations is also used to compute the amount of the contractor's invoice. Ordinarily, the rock formation type (such as sand, shale, lime, etc.) is the only geological information recorded, if any.

Driller's logs can be very important in determining the source of problems that occur later during well operation and in resolving uncertainties with regard to exactly how subsurface facilities are installed. Table 3-3 summarizes a part of the construction history of the Reichold Chemicals Incorporated well as prepared from driller's logs.

TABLE 3-3. PORTION OF THE CONSTRUCTION HISTORY OF  
THE REICHOOLD CHEMICALS INCORPORATED WELL,  
ALABAMA (TUCKER AND KIDD, 1973)

---

Drilling Engineer's Log  
Reichold Chemicals, Incorporated  
Reichold Research Waste Disposal Well No. 1  
Holt, Tuscaloosa County, Alabama

---

- 5-26-70: Spudded 4:00 p.m.
- 5-27-70: 8:00 a.m.-drilling 20-inch conductor hole at 40 feet.  
9:00 a.m.-shut down and repair rig.  
8:30 p.m.-resumed drilling. Drilled for 6 hours 20-inch conductor hole at 68 feet.
- 5-28-70: 8:00 a.m.-shut down to repair rig.  
8:00 a.m. to 3:00 p.m.-repair rig. Work on swivel, replace belts on pump and re-align, take air chamber off of rig pump, and replace gasket. Drain mud tanks and refill with city water. Welding on rig.  
3:00 p.m. to 4:00 p.m.-drilling 20-inch hole to 73 feet.  
4:00 p.m. to 8:00 p.m.-repairing rig.  
8:00 p.m. to 9:00 p.m.-cut off 24-inch casing and prepare to run 16-inch casing.  
9:00 p.m.-running 16-inch casing. Hit bridge. Rig up swage to wash down.  
11:00 p.m.-Halliburton on location.  
11:30 p.m.-unable to wash and work casing past 34 feet. Pulled 16-inch casing out of hole. Went in hole with bit.
- 5-29-70: 12:15 a.m.-reaming 20-inch hole.  
7:00 a.m. to 10:00 a.m.-running 16-inch casing. Hit tight spot at 45 feet. Could not work casing past that point.  
10:30 a.m.-rigged up Halliburton. Began reaming and pumping cement at 11:20 a.m. Ran 45.65 feet of 16-inch H-40 65 lb/ft. casing. Cemented with 75 sacks of Portland/A cement and 75 sacks of Pozmic A cement with 2% calcium chloride. Plug down at 12:00 noon with returns to surface.  
12:00 p.m. to 8:00 p.m.-waiting on cement.  
8:00 p.m.-cut 16-inch casing and nipped up flow lines to pits.  
11:00 p.m. to 12:30 a.m. (5-30-70)-drilling cement and washing to bottom of hole.
- 5-30-70: 12:30 a.m. to 11:00 a.m.-drilling 13 3/4-inch hole.  
11:00 a.m.-jet pits and fill same with fresh water.  
12:30 p.m. to 8:00 p.m.-drilling 13 3/4-inch hole at 114 feet.  
3:00 p.m. to 9:00 p.m.-drilling 13 3/4-inch hole. Ran Straight Hole Test. Hole deviation 7 degrees.  
9:00 p.m.-pulled out of hole. Laid down 2 stabilizers and near bit reamers. Pick up string reamer and 9 3/8-inch bit.
-



## Drilling Time Logs --

A drilling time log is often kept by the driller when hole depth approaches a zone of particular interest. Such a record is quite useful for precisely locating formations or porous zones. Abrupt changes in drilling rate will immediately indicate a change in lithology although the cuttings may not reach the surface for some time.

Mechanical devices which furnish a continuous record of drilling progress are also in common use. The record obtained is quite accurate and includes an accounting of all non-drilling time. Two lines are obtained, as shown in the sample chart of Figure 3-5. The left hand track furnishes the foot-by-foot drilling rate by recording a diagonal line (to the left and upward) as each foot is drilled. The offsets to the right occur at intervals of five feet. Non-drilling time is shown by the deflections to the right on the right hand track. The net drilling time is obtained by subtracting any non-drilling time from the total interval.

## Mud Logs --

Mud logging, as the term is used here, refers to the continuous analysis of the drilling mud for oil and gas content. This procedure is widely used in exploratory drilling, and affords an extra tool for detecting the presence of oil and gas. In mud logging, a portion of the drilling mud is diverted from the return flow line and inspected for the presence of oil and gas. The instruments used for detecting and measuring the quantities of hydrocarbons in the mud are commonly contained in a trailer which is set up at the drilling site.

The discovery of hydrocarbons is not normally an objective when drilling an injection well; however, in areas where oil or gas may be present, mud logging can be employed to decrease the possibility of bypassing these resources or to avoid the safety hazard that exists in continuing to construct a well within an open gas-bearing reservoir.

## Geophysical Logs --

After a well has been drilled, a variety of logging tools are available that can be used to produce a record of the geophysical properties of the formations penetrated and their contained fluids. In such logging, a probe is lowered into a well at the end of a wire cable and measurements made and automatically recorded at the surface. The geophysical properties that are measured include electrical resistivity and conductivity, ability to transmit and reflect sonic energy, natural radioactivity, hydrogen ion content, temperature, density, etc. These geophysical properties are then interpreted in terms of lithology, porosity, fluid content, and chemistry. Table 3-4 lists many current geophysical well logging methods, the properties they measure, and their practical applications.

Large diameter deep wells are logged by companies that specialize in this service. Many of the common geophysical logs run by major service companies are listed in Table 3-5 by their trade name. See also the variety of

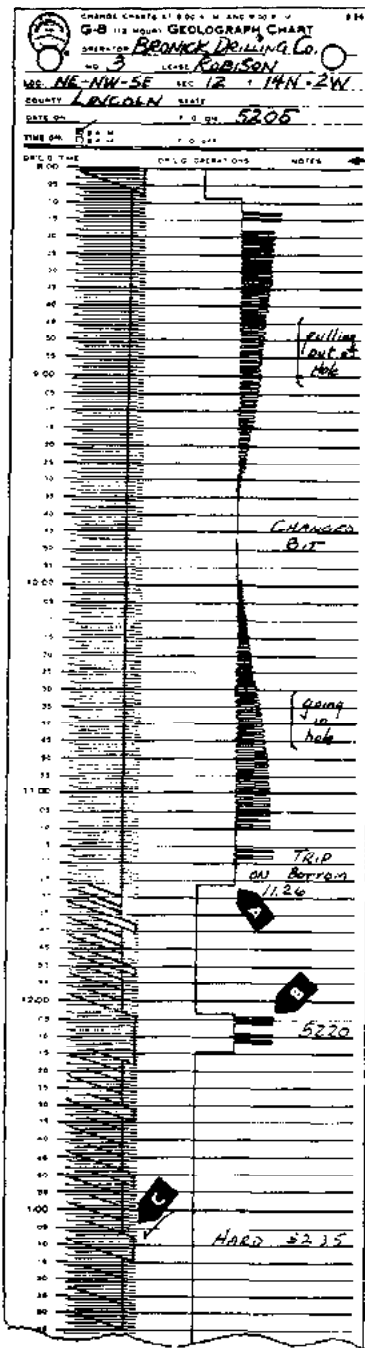

**A** Line in drilling operations column moves to the left indicating that driller got on bottom with new bit and started drilling at 11:26. Total trip time, as indicated by "Trip Action", 3 hours and 17 minutes.

**B** This is the way a connection looks on the Geograph chart. The driller raised the drill pipe from bottom at 12:03, broke out the kelly, picked up a single pipe (adding it to the drilling string), picked up the kelly and resumed drilling. This operation required 11 minutes, and the driller has written the depth of the hole, at that time, on the chart. Thus, every connection is a convenient datum for determining the depth of any drilling or down-time break, either immediately above or below.

**C** A 4-foot hard streak was encountered at 5,235 feet, as indicated by the increased spacing of the foot marks on this time chart.

**D** A connection was made at 5,259 feet and a vertical test was run at this point to determine the vertical deviation of the hole. The driller has noted on the chart that the test was actually taken at 5,250 feet and the deviation was 1/2 degree. The vertical test and connection required 34 minutes.

**E** Soft bed was drilled from 5,266 to 5,269 feet. Because of the thinness of this bed, no core or drill stem test was attempted.

**F** This section represents 5 feet of drilling. Note that every 5 feet the base line is offset for 1 foot, making a convenient marker for determining the depth of significant drilling changes.

**G** Connection was made at 5,287 feet. Note similarity to the record at "B".

**H** A hard streak was encountered from 5,288 to 5,290 feet.

**I** At 5,290 feet, the formation softened, drilling continued to 5,300 feet where the driller was given orders to cease drilling and circulate for samples.

**J** Circulating for samples started at 6:39 as indicated by movement of the line to the right. After circulating for 35 minutes, samples showed stain and odor, and a drill stem test was ordered.

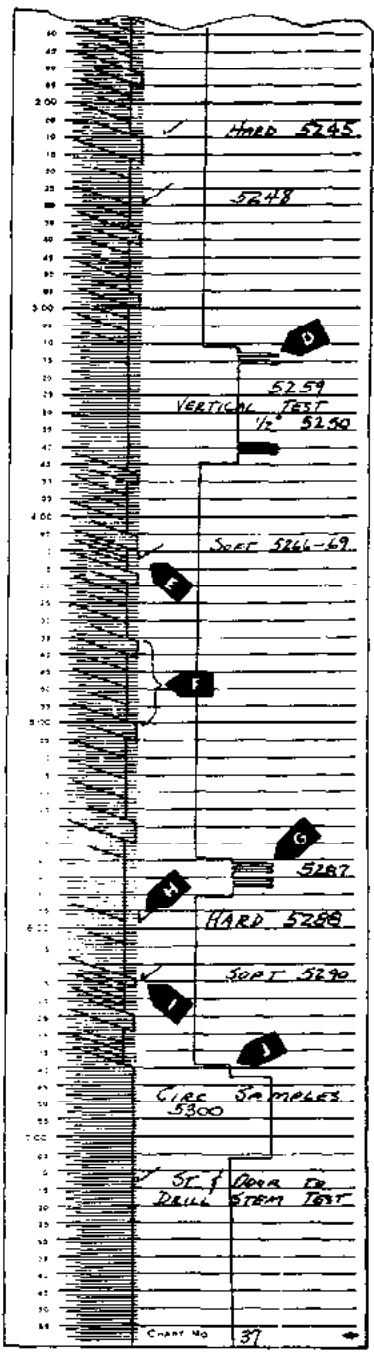

FIGURE 3-5. TYPICAL MECHANICAL DRILLING LOG RECORD (GATLIN, 1960, P. 196).

TABLE 3-4. GEOPHYSICAL WELL LOGGING METHODS AND THEIR APPLICATIONS (MODIFIED AFTER JENNINGS AND TIMUR, 1973).

	Method	Property	Application
ELECTRICAL	Spontaneous Potential (SP)	Electrochemical and electrokinetic potentials	Formation water resistivity ( $R_w$ ); shales and nonshales; bed thickness; shaliness
	Nonfocused Electric Log	Resistivity	a. Water and gas/oil saturation b. Porosity of water zones c. $R_w$ in zones of known porosity d. True resistivity of formation ( $R_t$ ) e. Resistivity of invaded zone
	Focused Conductivity Log	Resistivity	a,b,c,d Very good for estimating $R_t$ in either freshwater or oil base mud
	Focused Resistivity Logs	Resistivity	a,b,c,d Especially good for determining $R_t$ of thin beds  Depth of Invasion
	Focused and Nonfocused Microresistivity Logs	Resistivity	Resistivity of the flushed zone ( $R_{XO}$ ) for calculating porosity  Bed thickness
ELASTIC WAVE PROPAGATION	Transmission	Compressional and shear wave velocities  Compressional and wave attenuations	Porosity; lithology; elastic properties, bulk and pore compressibilities  Location of fractures; cement bond quality
	Reflection	Amplitude of reflected waves	Location of voids, fractures; orientation of fractures and bed boundaries; casing inspection

(Continued)

TABLE 3-4. (CONTINUED)

	Method	Property	Application
RADIATION	Gamma Ray	Natural radioactivity	Shales and nonshales; shaliness
	Spectral Gamma Ray	Natural radioactivity	Lithologic identification
	Gamma-Gamma	Bulk density	Porosity, lithology
	Neutron-Gamma	Hydrogen content	Porosity
	Neutron-Thermal Neutron	Hydrogen content	Porosity; gas from liquid
	Neutron-Epithermal Neutron	Hydrogen content	Porosity; gas from liquid
	Pulsed Neutron Capture	Decay rate of thermal neutrons	Water and gas/oil saturations; reevaluation of old wells
	Spectral Neutron	Induced gamma ray spectra	Location of hydrocarbons; lithology
OTHER	Gravity Meter	Density	Formation density
	Ultra-Long Spaced Electric Log	Resistivity	Salt flank location
	Nuclear Magnetism	Amount of free hydrogen; relaxation rate of hydrogen	Effective porosity and permeability of sands; porosity for carbonates
	Temperature Log	Temperature	Formation temperature

TABLE 3-5. SOME GEOPHYSICAL WELL LOGGING SERVICES AVAILABLE FROM THREE COMPANIES PROVIDING WELL LOGGING SERVICES. EQUIVALENT TYPE LOGS ARE LISTED ON THE SAME LINE ACROSS THE TABLE.

WELL LOG TYPE	COMPANY	
	SCHLUMBERGER	DRESSER - ATLAS
Electrical Log	Electrical Log	Electrolog
Induction Electrical Log	Induction Electrical Log	Induction Electrolog
Dual Induction Guard Log	Dual Induction Laterolog	Dual Induction Focused Log
Guard Log	Laterolog -3, Laterolog -7	Laterolog
Densit Log	Microlog	Minilog
Micro Log	Microlaterolog	Micro-Laterolog
Proximity Log	Proximity Log	Proximity Log
Acoustic Velocity Log	Sonic Log	Acoustilog
Compensated Acoustic Velocity Log	BHC Sonic Log	BHC Acoustilog
Fracture Finder Log	Amplitude Log	Fraclog
Variable-Density Log	Variable Density Log	Variable Amplitude Density Log
Density Log	Formation Density Log	Densilog
Compensated Density Log	Compensated Formation Density Log	Compensated Densilog
Simultaneous Gamma Ray-Neutron Log	Gamma Ray-Neutron Log	Gamma Ray-Neutron Log
Sidewall Neutron Log	SNP Neutron Log	Epithermal Sidewall Neutron Log

available logging methods is so great, those used in logging a well must be carefully selected to provide the desired information at an acceptable cost. Local practice in the particular geographic area is a valuable guide, since it represents the cumulative experience obtained from logging many wells. Some of the objectives in logging injection wells will generally be the determination of: lithology; bed thickness; amount, location and type of porosity; and salinity of formation water. In order to achieve these objectives, a commonly chosen suite of logs will include a gamma ray log, a focused resistivity log, and one or more porosity measuring logs selected from among the various radiation and elastic wave logs. Some other frequently used geophysical logs include the spontaneous potential (SP) and nonfocused electric logs, along with miscellaneous logs such as the caliper log and the temperature log.

Figures 3-5a, 3-6, and 3-7 are intervals from a sonic log, a Laterolog-gamma ray-neutron log, and a temperature log run in a wastewater disposal well in northern Illinois. On the Laterolog-gamma ray-neutron log, the contact between the Eau Claire Formation and the Mt. Simon Formation is shown at 3108 feet where it was picked by the Illinois Geological Survey. However, it is apparent from the gamma ray log that, for engineering purposes, the shale confining interval terminates at 2900 feet and that sandstones usable for injection begin at 2900 feet. The combined Mt. Simon Formation and the sandstones in the lower Eau Claire Formation comprise the Mt. Simon aquifer or "basal sandstone." From the sonic log, it can be seen that the first sandstone interval from 2900 to 2940 feet has an average interval transit time of about 72 microseconds per foot. Using tables provided by the logging company (Schlumberger, 1972a) and a matrix velocity of 19,500 ft/second, the average porosity of this sandstone body is estimated as 15 percent. The temperature log shows a temperature of about 83.5° F from 2900 to 2940 feet, and from the Laterolog (Figure 3-5), the resistivity of this interval is about 40 ohm-meters. From the Archie equation (Schlumberger, 1972) the formation factor  $F$  is 45 and the resistivity of the formation water is 0.625 ohm-meters. Figure 3-8 shows that sodium chloride water with a resistivity of 0.625 ohm-meters has a dissolved solids content of about 8,000 ppm at 83.5° F. Actually, the formation water salinity is about twice the calculated value because the Laterolog yields incorrectly high resistivities when run in low-salinity mud, as is the case here. An induction log would yield more accurate results in such a situation. This example illustrates some of the principal uses of borehole geophysical logs in conjunction with the evaluation of geological conditions in wastewater injection wells. Further uses will be covered in Chapter 8 on well monitoring. Keys and Brown (1973) give a more complete discussion and bibliography of the application of borehole geophysical logs to wastewater injection than is possible here. Other excellent references are Pirson (1963), Lynch (1962), and Haun and LeRoy (1958).

#### Miscellaneous Logs --

Among the logs classified here as miscellaneous logs are caliper logs, which measure borehole diameter; dipmeter logs, which measure the angle of dip of beds penetrated by the well; deviation logs, which measure the degree of deviation of the well bore from the vertical; and production-injection logs.

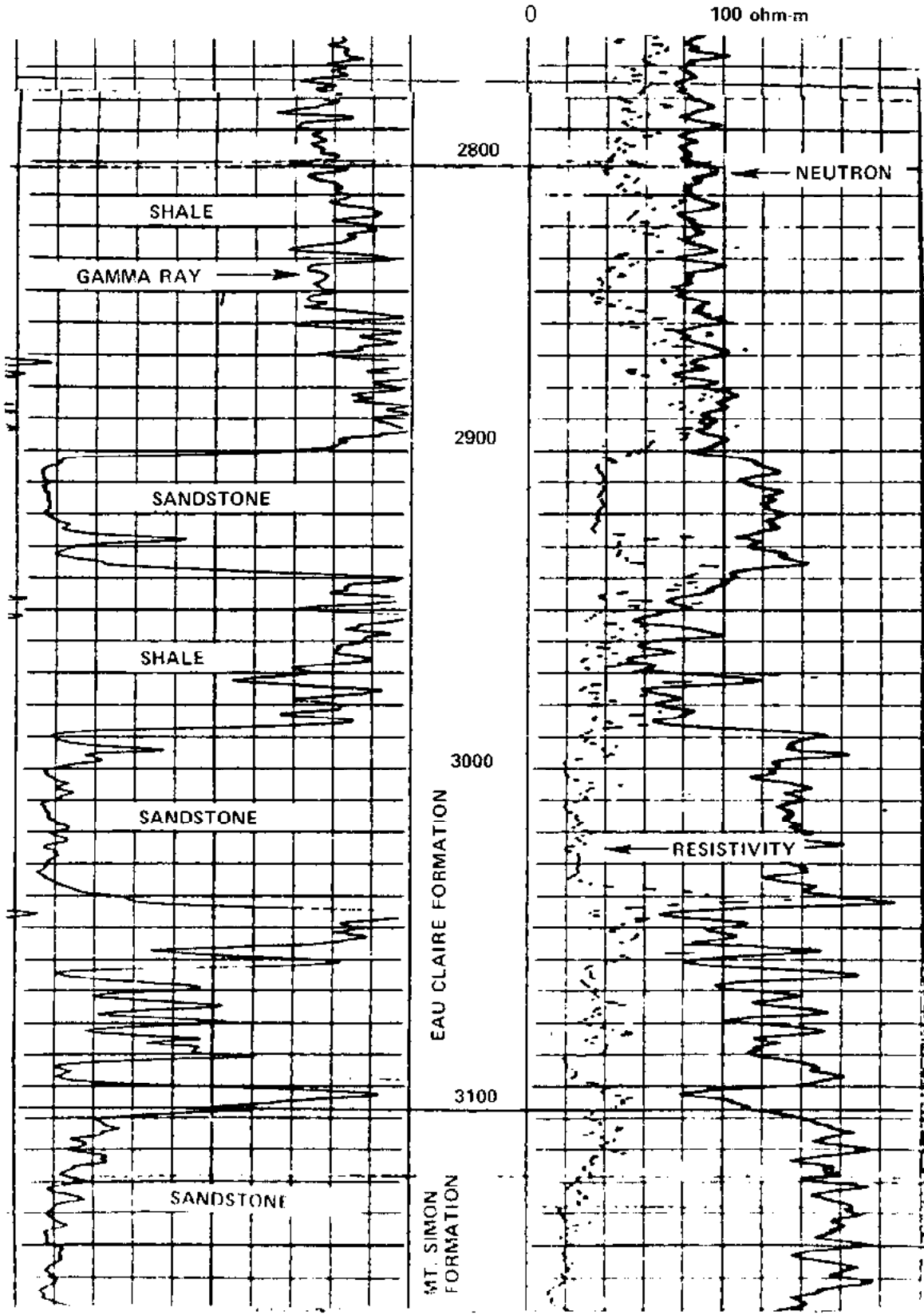

FIGURE 3-5a. PORTION OF A LATEROLOG-GAMMA RAY-NEUTRON LOG FROM A DEEP WELL IN NORTHERN ILLINOIS.

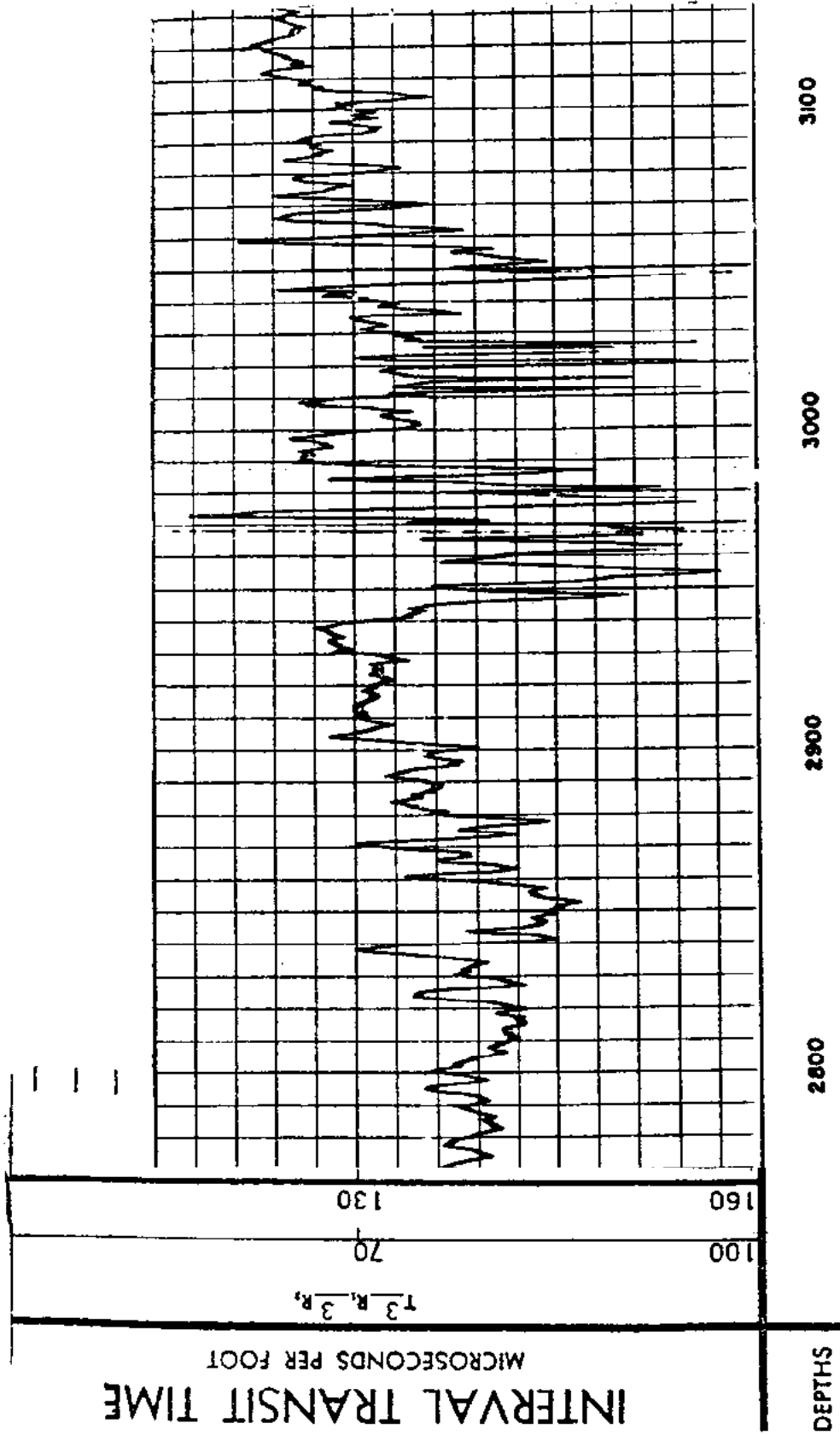

FIGURE 3-6. PORTION OF A SONIC LOG FROM A DEEP WELL IN NORTHERN ILLINOIS.



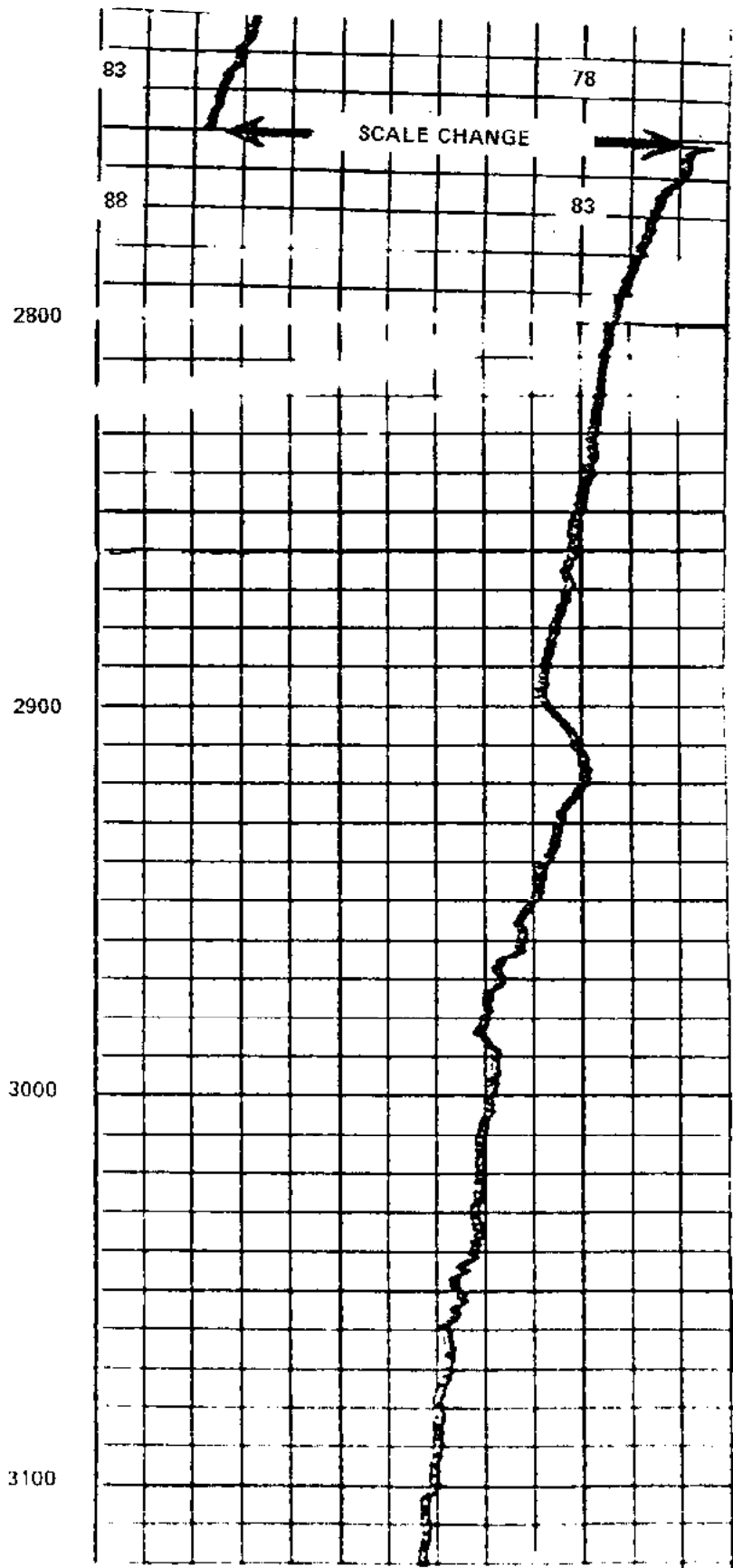

FIGURE 3-7. PORTION OF A TEMPERATURE LOG FROM A DEEP WELL IN NORTHERN ILLINOIS.

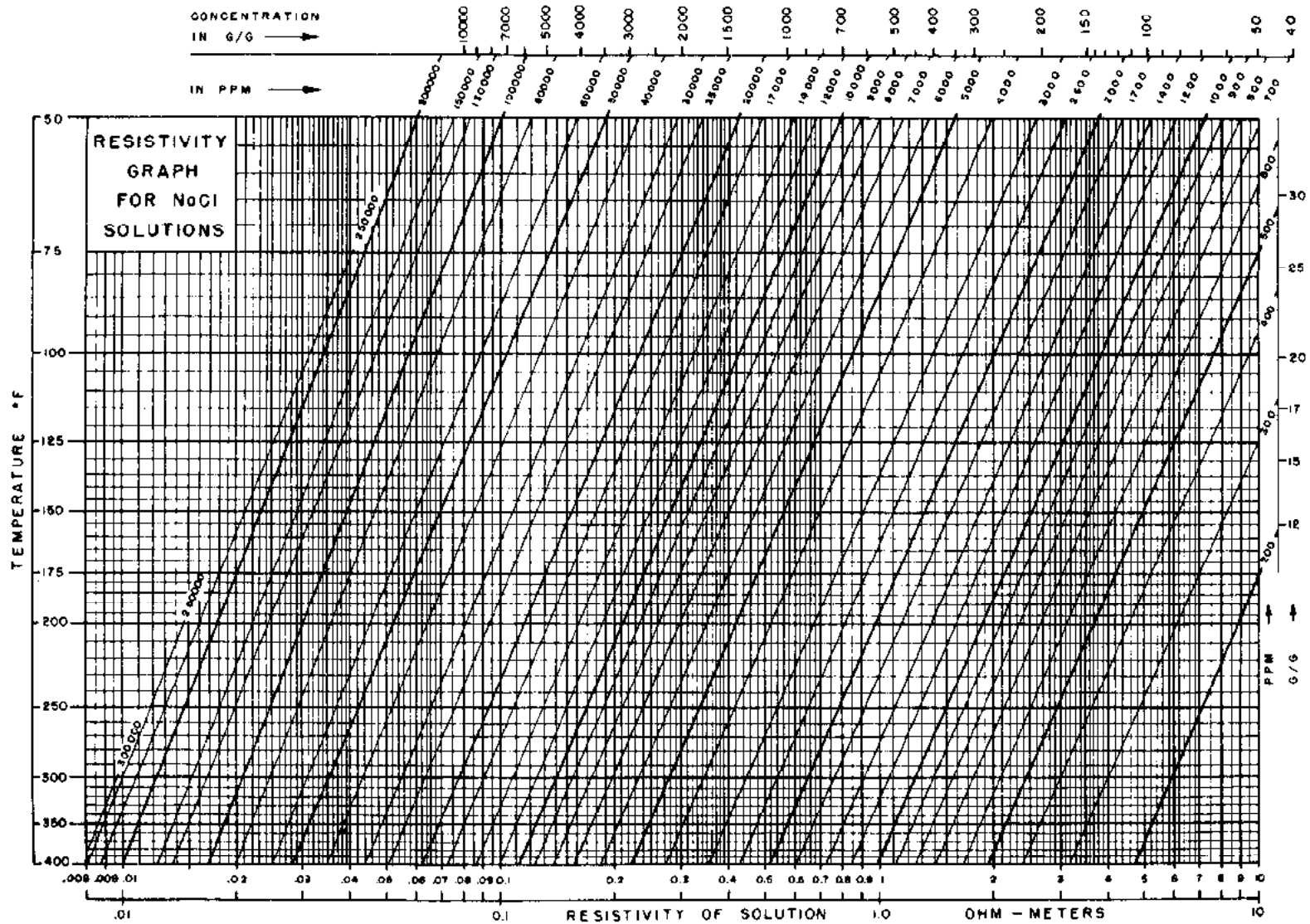

FIGURE 3-8. CHART FOR DETERMINATION OF SALINITY FROM SOLUTION RESISTIVITY (SCHLUMBERGER, 1972a). IN THE EXAMPLE GIVEN, ENTER THE CHART AT THE BASE WITH A RESISTIVITY OF 0.625 OHM-METERS, THEN PROCEED VERTICALLY TO THE FORMATION TEMPERATURE OF 83.5° F. FROM THAT POINT, FOLLOW THE DIAGONAL LINES TO THE TOP OF THE CHART, WHERE THE NaCl CONCENTRATION IS READ AS ABOUT 8,000 ppm.

The diameter of an uncased well is needed for quantitative use of many of the geophysical logs and it is also useful in lithologic interpretation and cement volume calculations. Data from dipmeter surveys assist in interpretation of geologic structure. Deviation of boreholes from the vertical is undesirable and periodic surveys are made during drilling to check borehole orientation.

Production-injection logs are classified here as those logs that are normally run through tubing or casing after the well is completed. Some of these logs are the same as ones previously listed, but a number of specialized logs are also used.

The principal uses of production-injection logs are to determine:

1. The physical condition of subsurface facilities and the borehole
2. The location of production or injection zones
3. The quantity of fluid produced from or injected into a particular zone
4. The results of wellbore stimulation treatment

Table 3-6 is a list of some production-injection logs that are most significant in wastewater injection operations. The function of each of the logs is also given. Examples of the use of a number of these logs are given in Chapters 8 and 9. Further description of production-injection logs can be found in the literature of the companies providing such logging services.<sup>1</sup>

### Testing of Injection Units and Confining Intervals

Examination of the records of many of the wastewater injection wells that have been constructed up to the present time shows that, with few exceptions, the maximum amount of usable geologic and engineering information has not been obtained during the testing of wastewater injection wells. This is regrettable, because such tests provide the best basis for analyzing reservoir conditions prior to injection, for predicting the long-term behavior of the well and the reservoir, for detecting and understanding changes in well performance that may occur during operation, and for analyzing the history of a well from its records.

The methods for testing pumping or injection wells and the techniques for analysis of test data are discussed in numerous textbooks and in hundreds of other publications concerning groundwater and petroleum engineering.

<sup>1</sup>Birdwell Division, Seismograph Service Corporation, Tulsa, Oklahoma; Dresser Atlas, Houston, Texas; McCullough Services, Ramold Division Oil Industries, Inc., Houston, Texas; Schlumberger, Houston, Texas; Welco, Houston, Texas.

TABLE 3-6. PRODUCTION-INJECTION LOGS MOST USEFUL IN LOGGING INJECTION WELLS AND THEIR FUNCTION

LOG	FUNCTION
1. Cement bond	Determine extent and effectiveness of casing cementing
2. Gamma ray	Determine lithology and presence of radioactive tracers through casing
3. Neutron	Determine lithology and porosity through casing
4. Borehole televiewer	Provide an image of casing wall or well bore
5. Casing inspection	Locate corrosion or other casing damage
6. Flowmeter	Locate zones of fluid entry or discharge and measure contribution of each zone to total injection or production
7. High resolution thermometer	Locate zones of fluid entry including zones behind casing
8. Radioactive tracer	Determine travel paths of injected fluids including behind casing
9. Fluid sampler	Recover a sample of wellbore fluids
10. Casing collar	Locate casing collars for accurate reference
11. Fluid pressure	Determine fluid pressure in borehole at any depth
12. Casing caliper	Locate casing damage

Because the number of published articles and the scope of their content are so extensive, only a few selected references are mentioned and a few examples discussed here to establish the reasons for and methods of well testing.

A well can be tested by pumping from it or injecting into it. Measurements of reservoir pressure or water level can be made during pumping or injection or, alternatively, after pumping or injection has ceased and the reservoir is adjusting to its original condition. Furthermore, reservoir pressure or water level can be measured in the principal well or in adjacent observation wells. Any one of these approaches will yield much of the same information; however, there are benefits and problems associated with either injection or pumping tests that should be recognized.

The principal advantage of injection testing is that, since fluids are to be injected during actual well operation, injection tests are more likely to replicate operating conditions. Another advantage of injection tests is that injection pumps are used on the ground surface, whereas pumps for production testing will usually be submersible down-hole pumps that are more time-consuming and expensive to use. Disadvantages of injection testing are that, unless great care is exercised, the injection interval can be damaged and the test results affected by reactions of the injected fluid with formation fluids or minerals. Differences between viscosity, density, or temperature of interstitial and injected fluids may also affect test results.

Production (pumping) tests avoid the potential for incompatibility between injected and interstitial fluids and formation minerals, but the problem of disposal of the produced formation water then arises. This water can be reinjected, but chemical, physical, or biological changes often occur when the water is brought to the surface that require the water to be treated before it is returned to the subsurface.

#### Drill-Stem Testing --

In the case of the usual deep and rather expensive wastewater injection well, there will be no observation well and testing will be in the well itself. In the sequence of well construction and testing, the first type of formation test that is likely to be made is the drill-stem test (DST). As has previously been mentioned on Page 71, this test is analogous to a pumping test of limited duration. Quantitative analysis is usually made using data obtained during the period of pressure buildup (closed-in-period) following the period in which the reservoir is allowed to flow.

Figure 3-9a is a schematic DST pressure record, with a description of the sequence of events in a successful test with a single flow period. Figure 3-9b is a schematic representation of a test in which no fluid was produced. Conditions that may be encountered in a DST are widely variable and considerable experience may be required in order to interpret an unusual test. The companies that provide the testing services also provide assistance in test interpretation.

If a test is successful, pressure buildup data from the test are taken from the DST chart and tabulated. These data are then plotted on a semi-log

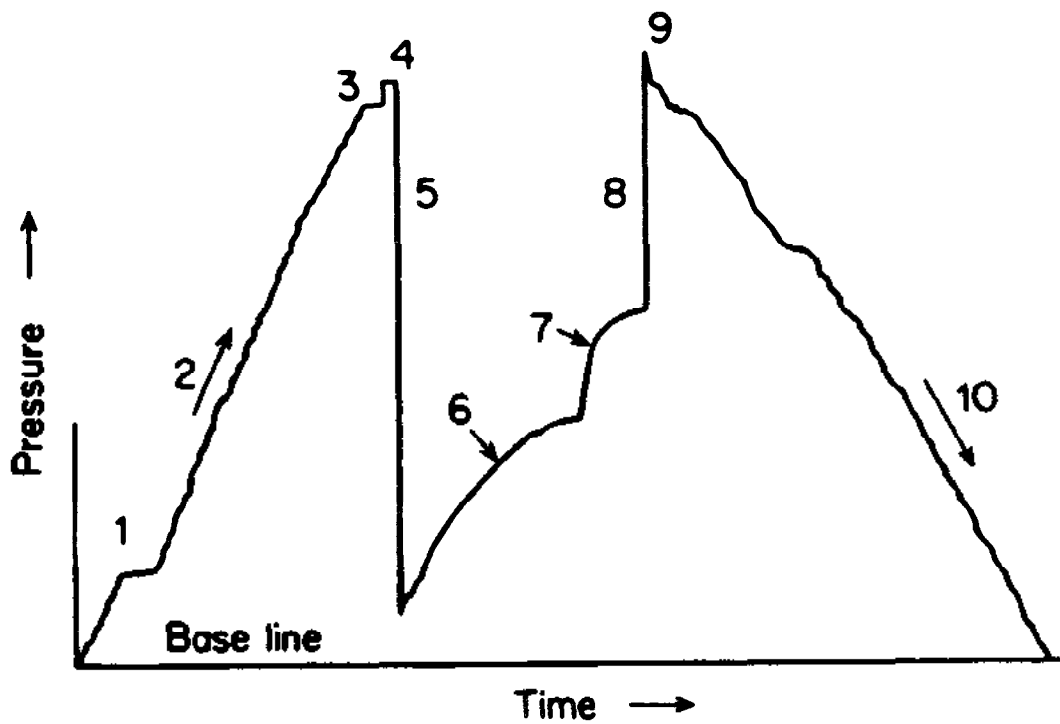

1. Putting water cushion in drill pipe
2. Running in hole
3. Hydrostatic pressure (weight of mud column)
4. Squeeze created by setting packer
5. Opened tester, releasing pressure below packer
6. Flow period, test zone producing into drill pipe
7. Shut in pressure, tester closed immediately above packer
8. Equalizing hydrostatic pressure below packer
9. Released packer
10. Pulling out of hole

FIGURE 3-9a. NORMAL SEQUENCE OF EVENTS AS RECORDED ON THE CHART DURING A SUCCESSFUL DRILL-STEM TEST (KIRKPATRICK, 1954).

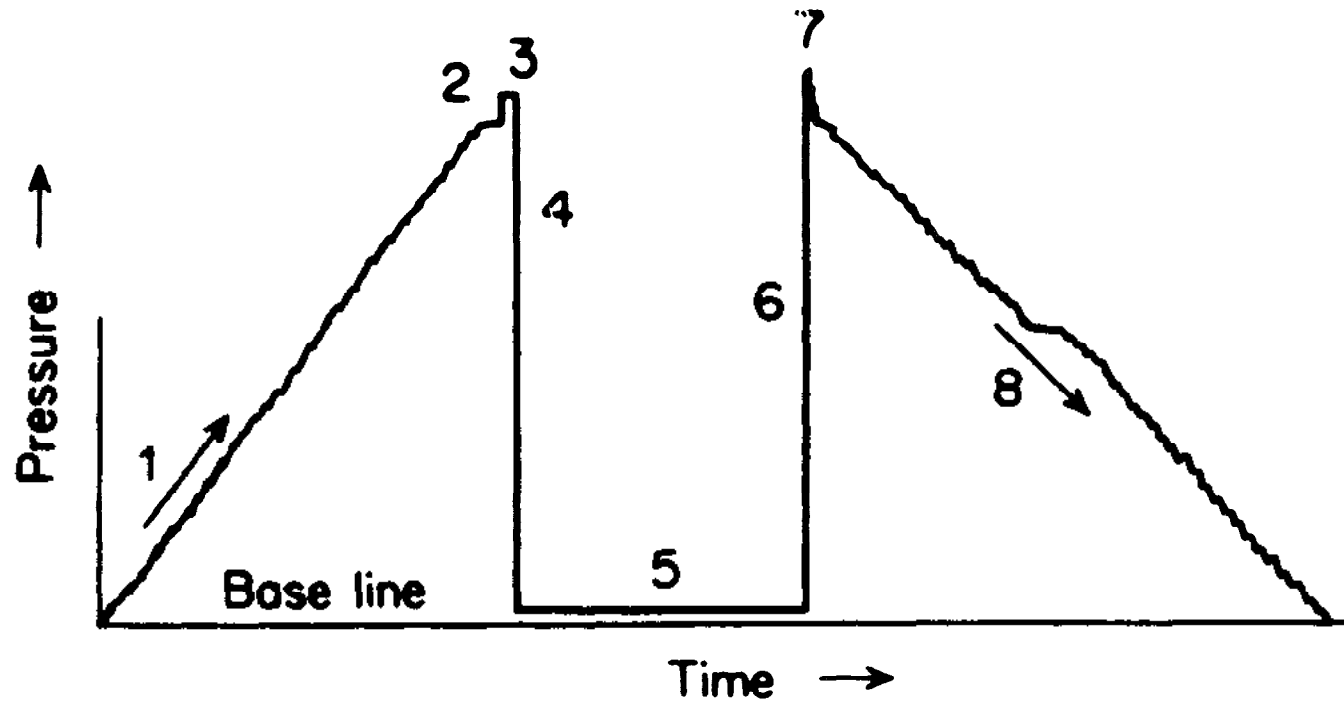

1. Running in hole
2. Hydrostatic pressure (weight of mud column)
3. Squeeze created by setting packer
4. Opened tester, releasing pressure below packer
5. Flow period, test zone open to atmosphere
6. Closed tester and equalizing hyd. pressure below packer
7. Pulled packer loose
8. Pulling out of hole

FIGURE 3-9b. SEQUENCE OF EVENTS AS RECORDED DURING A DRILL-STEM TEST WHEN NO FLUIDS WERE PRODUCED (KIRKPATRICK, 1954).

Figure 3-10, the graph at the top of the figure is the record of a DST with dual flow and closed-in periods. The abbreviation ICIP signifies the initial closed-in-period, FFP the final flow period, and FCIP, the final closed-in-period. The data for both closed-in periods are plotted, as is shown in the figure for the final period. The vertical axis of the plot is pressure, as taken from the DST record, in psi. The horizontal axis is a plot of the logarithm of time during a flow period plus time during the closed-in period  $(t + \theta)$ , divided by time during the shut in period  $(\theta)$ . When this plot is extrapolated to infinite time,  $(t + \theta)/\theta = 1$  (the logarithm of one is zero) the intersection of the straight line, drawn through the data points, with the vertical axis is interpreted as being the original reservoir pressure or static formation pressure ( $P_s$ ). The slope of the line ( $m$ ) is the pressure difference for one log cycle ( $P_s - P_{10}$ ). A series of calculations of formation properties is then made.

The important properties that are routinely calculated are:

1. Static formation pressure
2. Transmissivity
3. Average effective permeability
4. Damage ratio
5. Radius of investigation.

The static formation pressure as determined from a successful test is assumed to closely represent the original formation pressure at the elevation of the pressure recording device. Transmissivity is average hydraulic conductivity multiplied by the thickness of the test interval. The damage ratio is an indication of the amount of plugging of pores in the formation during drilling of the well. In addition to this routine information, drill-stem tests may indicate the presence of and distance to nearby faults or facies changes that act as barriers to flow or channels for rapid flow.

For detailed presentations of drill-stem test analysis, the reader is referred to Gatlin (1960), Lynch (1962), Matthews and Russel (1967) and Pirson (1963). Also, literature such as that by Murphy (undated) and Edwards and Winn (1974) is readily available from companies that provide drill-stem testing services.

As an example of DST analysis, data from one closed-in period obtained during testing of the Mt. Simon Formation in a well in Ohio were selected. Figure 3-11 is a plot of the pressure buildup data for that test. Extrapolation of the data to the logarithm of  $(t + \theta)/\theta = 0$  shows that the static formation pressure ( $P_s$ ) is 2750 psig. The gauge was at a depth of 5886 feet in the well, so the fluid pressure gradient is 0.467 psi per foot of depth.

For the remaining calculations, the following additional values from the test are needed (see any of the above references):

$P_f$  = pressure at the end of the final flow period = 1061 psig

$t$  = flow time = 62 min



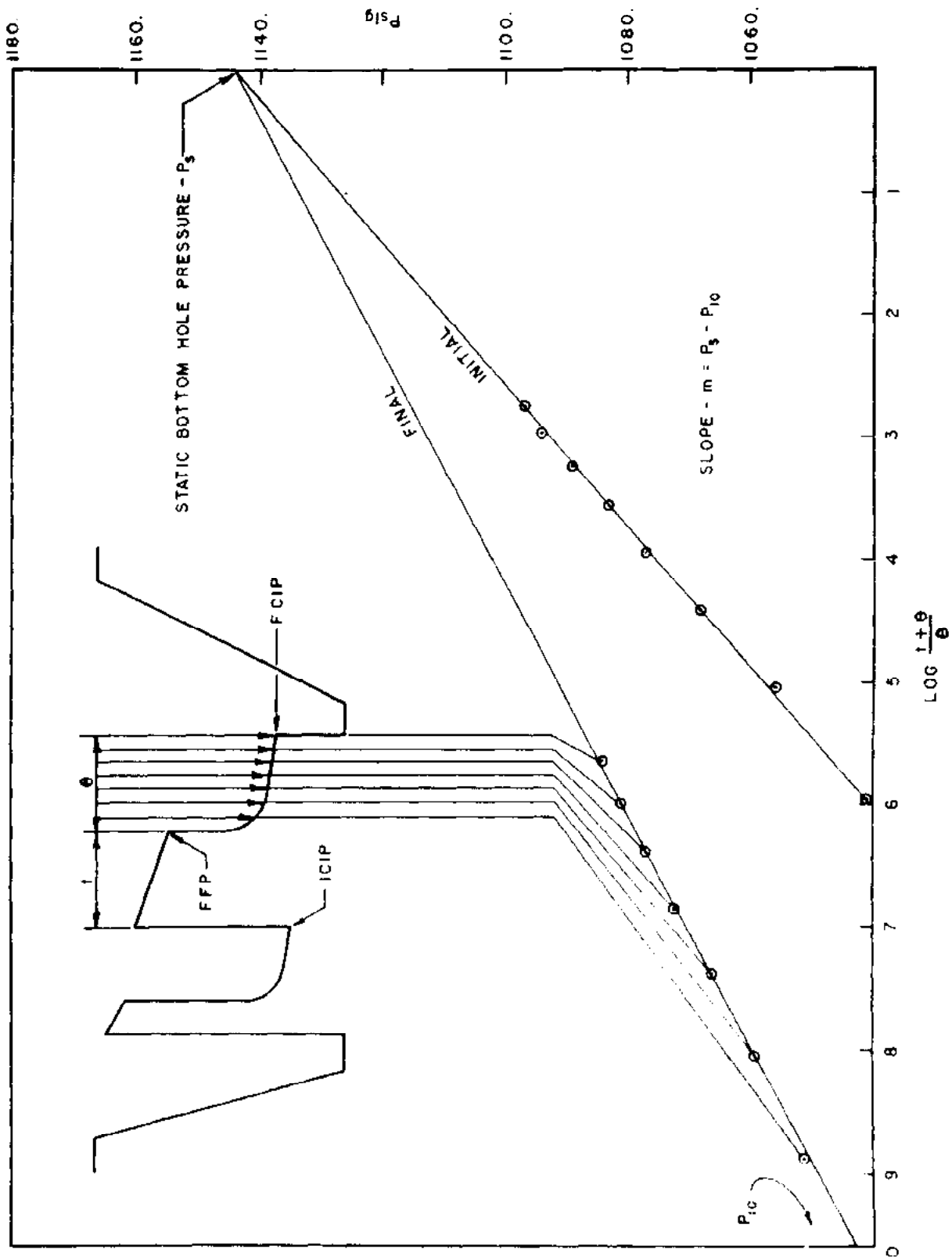

FIGURE 3-10. EXAMPLE OF A PLOT OF DATA FROM A DRILL-STEM TEST WITH DUAL CLOSED-IN PERIODS (MURPHY, UNDATED).

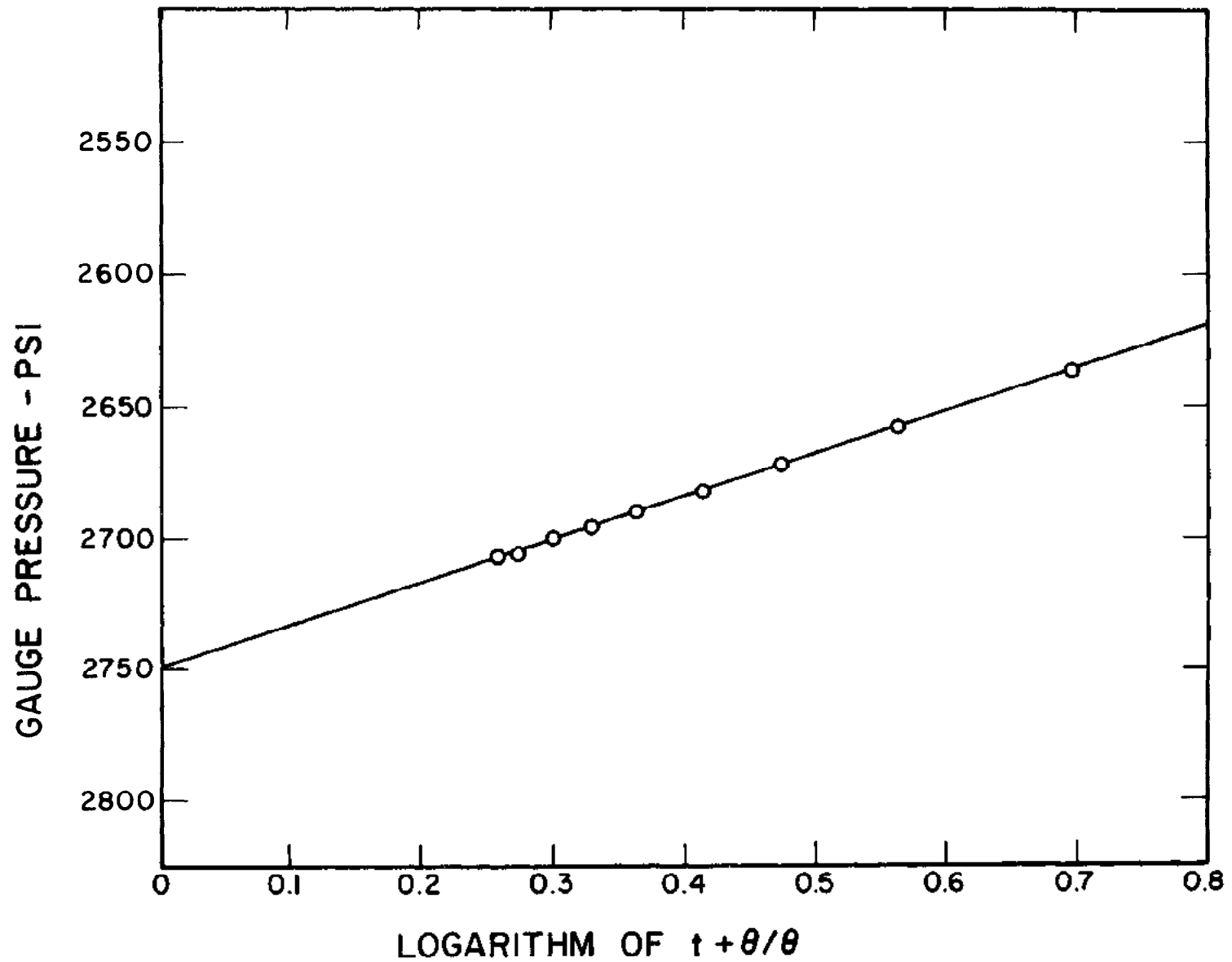

FIGURE 3-11. PLOT OF EXTRAPOLATED PRESSURE FROM DRILL-STEM TEST DATA FROM AN INJECTION WELL IN OHIO.

$$m = P_s - P_{10} = 163 \text{ psi per log cycle}$$

$$Q = \text{average flow rate} = 347 \text{ bbl/day}$$

$$\mu = \text{water viscosity} = 1.065 \text{ centipoise}$$

$$b = \text{formation thickness} = 105 \text{ ft.}$$

Then,

$$T = \text{transmissivity} = 162.6 \frac{Q}{m} \text{ (millidarcy-ft/centipoise)} \quad (3-1)$$

$$\bar{K} = \text{average permeability} = \frac{T \mu}{b} \text{ (millidarcys)} \quad (3-2)$$

$$DR = \text{damage ratio} = \frac{0.183 (P_s - P_f)}{m} \text{ (dimensionless)} \quad (3-3)$$

$$r = \text{radius of investigation} = (\bar{K}t)^{1/2} \text{ (feet)} \quad (3-4)$$

The transmissivity is computed to be 346 millidarcy-ft/centipoise, the average permeability 3.5 millidarcys, the damage ratio 1.9, and the radius of investigation 14.7 ft. These calculations reveal that the Mt. Simon Formation at this location has a very low capacity to accept injected fluids. The capacity could theoretically be improved nearly 100 percent by removing formation damage; reservoir stimulation by hydraulic fracturing would also help, but the reservoir is not promising. No hydrologic boundaries were encountered within the radius of investigation, which was only about 15 feet. Further well testing and core analysis results to confirm these findings are discussed in the material that follows.

#### Injectivity Testing --

After an injection well has been drilled and possible injection intervals identified by coring, by geophysical logging, and by drill stem testing, injection tests will usually be run. For initial injection testing, truck-mounted pumps are often rented and treated water used for injection rather than wastewater. Frequently, more than one possible injection interval is present and tests are performed on the intervals individually or on more than one at a time. The common practice when performing an injection test is to begin injection at a fraction of the final estimated rate, to inject at this rate for at least several hours, then to repeat this process at increasingly greater rates until a limiting rate or pressure is reached. Injection is then stopped and the reservoir allowed to return to its original pressure state. Pressures may or may not be recorded during this fall-off period.

Regardless of the sequence in which a test is performed, if pressure, time, and flow data are accurately recorded, and if the test is run long enough, it is theoretically possible to analyze the test. However, simpler tests tend to produce simpler and more reliable interpretations. Tests performed on more than one interval at a time are particularly difficult to

interpret and should be avoided if possible or alternately, both single and multiple zone tests should be performed.

Figure 3-12 is a plot of the data from a constant-rate injectivity test of the Mt. Simon Formation. The test was run at a rate of 75 gal/min for about 25 hours. To obtain a value of transmissivity, Equation 3-1 can be used, in which case, the result will be in millidarcy · ft/cp, as follows:

$$T = \frac{(162.6) (2571.4 \text{ bbl/day})}{925 \text{ psi/log cycle}} = 452 \text{ millidarcy} \cdot \text{ft/centipoise}$$

Alternately, a nonunitized equation can be used and the constant adjusted to give transmissivity in any desired set of units. Equation 3-1 in nonunitized form is (Ferris, et al., 1962; Kruseman and De Ridder, 1970; Lohman, 1972):

$$T = \frac{2.3 Q}{4\pi \Delta h} \quad [L^2/t] \quad (3-5)$$

If, for example, it is desired to obtain the answer in ft<sup>2</sup>/day, then the set-up would be:

$$T = \frac{(2.3) (14,437 \text{ ft}^3/\text{day})}{(4\pi) (1981 \text{ ft/log cycle})} = 1.33 \text{ ft}^2/\text{day}$$

This test was run on the same well for which the drill stem test analysis was given, but the well bore was cleaned up and acidized before the injectivity test, thus apparently leading to a slightly higher transmissivity (452 millidarcy·ft/cp as compared with 346 millidarcy·ft/cp.).

The injectivity test can further be used to determine the formation storage coefficient from (Ferris, et. al., 1962; Kruseman and DeRidder; Lohman, 1972).

$$S = \frac{2.25 T t_0}{r^2} \quad [\text{dimensionless}] \quad (3-6)$$

where

T = formation transmissivity

t<sub>0</sub> = intercept of extrapolated test curve with time axis

r = effective radius of well bore

Equation 3-6 is nonunitized. Unitized for ft<sup>2</sup>/day, minutes, and ft, it becomes:

$$S = \frac{T t_0}{640 r^2} \quad [\text{dimensionless}] \quad (3-7)$$

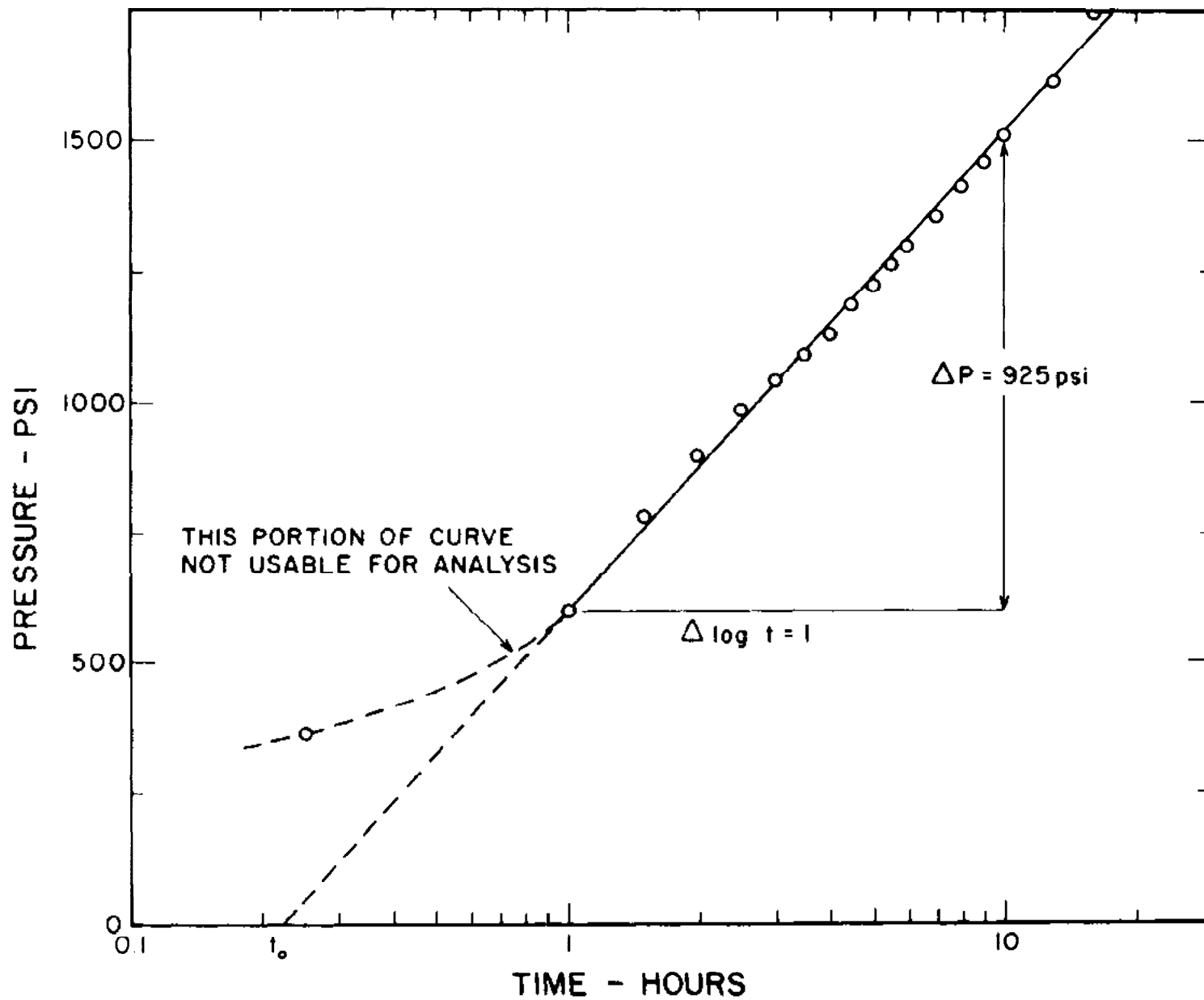

FIGURE 3-12. PLOT OF PRESSURE BUILDUP DATA FROM AN INJECTIVITY TEST OF THE MT. SIMON FORMATION IN OHIO.

From Figure 3-12,  $t_0 = 13.2$  minutes and:

$$S = \frac{1.33 \text{ ft}^2/\text{day} (13.2 \text{ min})}{(640) (0.396 \text{ ft})^2} = 0.175$$

As was discussed in Chapter 2, storage coefficient values for confined aquifers are generally at least three orders of magnitude lower than the calculated value of 0.175. It is believed that the unreasonable answer results from the fact that the well was hydraulically fractured during an earlier injection test, leading to a larger effective well radius. This is one of the problems encountered in determining reservoir properties using a single well. If an observation well existed, this difficulty would be eliminated. For this well, a more reasonable value of the storage coefficient can be obtained by using Equation 2-6 as was demonstrated in Chapter 2.

Another form of reservoir analysis that employs curve matching can also be used. A detailed explanation of this procedure is given by Ferris, et. al. (1962); Kruseman and DeRidder (1970) and Lohman (1972). Wilson et. al. (1973) applied curve matching to data from an injection well at Mulberry, Florida. The most interesting aspect of the example presented by Wilson et. al. (1973) was that it appeared to show an observable amount of leakage through confining beds. Witherspoon and Neuman (1972) discuss the theory and procedure for analysis of leaky confining beds and give two field examples from gas storage projects.

### Predicting Effects of Injection

One purpose of obtaining all of the many types of geologic and engineering information that have previously been discussed here and in Chapter 2 is to allow quantitative or semiquantitative estimates to be made of the effects of injection on the subsurface environment. These calculated effects are then used, along with all other information, as criteria in evaluating site suitability and in developing operating and monitoring plans.

#### Wastewater Transport by Regional Flow --

A frequently asked question is, How far will injected fluids be transported from the injection site by the natural flow system? An estimate of this can be made from Darcy's law (Equations 2-2, 2-3, 2-4).

Examples of such a calculation will be given for the Mt. Simon Formation in Ohio and for the lower Floridan aquifer in Florida. Figure 3-13 shows that, at the location of the Empire-Reeves injection well, the hydraulic gradient is about 10 feet per mile toward the northwest. At this location, the Mt. Simon Formation has an average permeability of 24 millidarcys (from a drill stem test) and a porosity of 10.4 percent (Clifford, 1973).

Rearranging Darcy's law:

$$\bar{v} = \frac{Q}{A} = \frac{kdh}{dL} \quad [L/T] \quad (3-6)$$

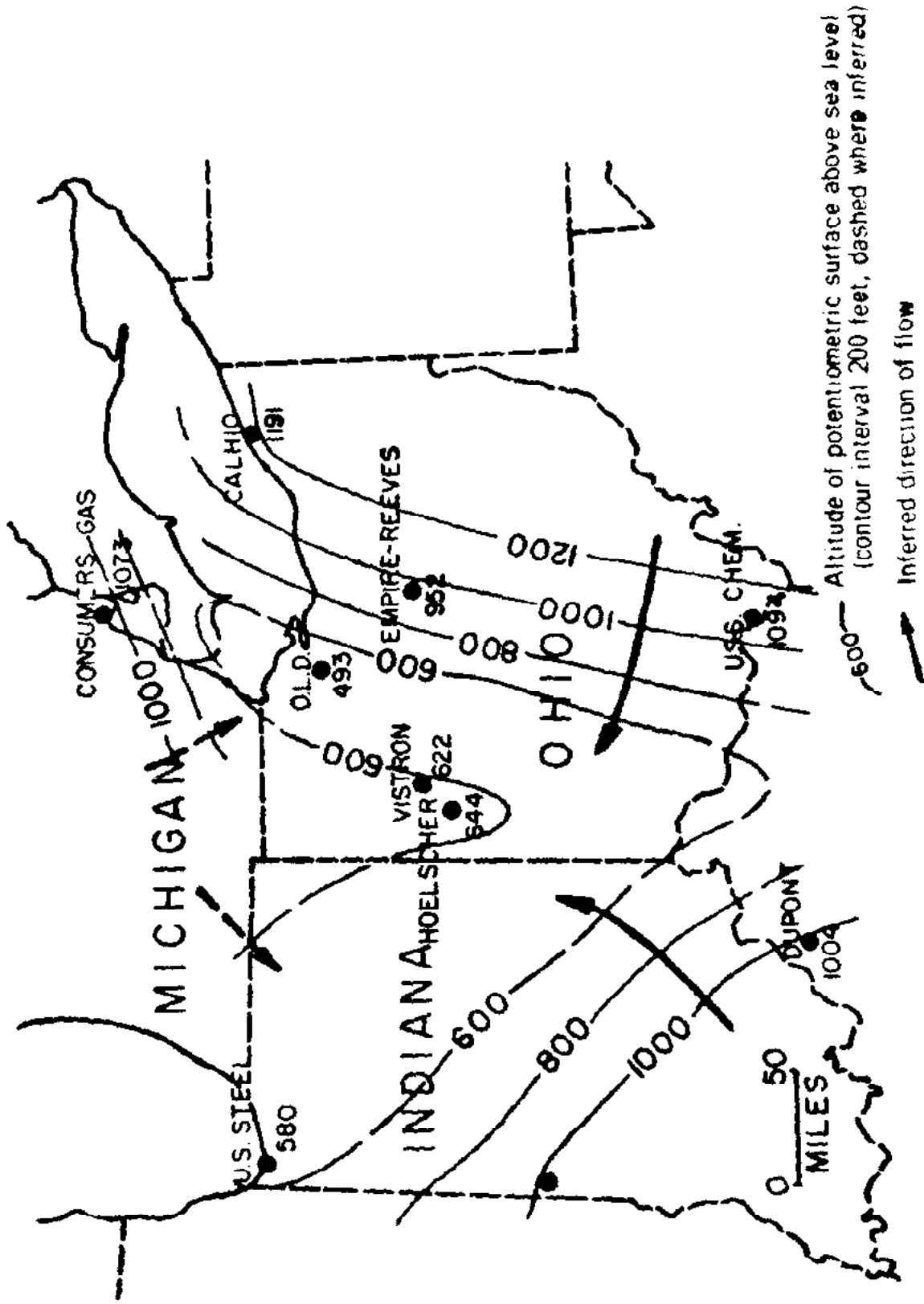

FIGURE 3-13. POTENTIOMETRIC SURFACE OF THE MT. SIMON FORMATION IN OHIO AND VICINITY (CLIFFORD, 1973).

where  $\bar{v}$  = apparent velocity through entire area A.

Then,

$$v = \frac{\bar{v}}{\phi} = \frac{Q}{A\phi} = \frac{K}{\phi} \frac{dh}{dL} \quad (3-7)$$

where  $v$  = average velocity of flow through pores

$\phi$  = porosity.

In order to use Equation 3-7, permeability must be converted into hydraulic conductivity in units consistent with the hydraulic gradient. Twenty-four millidarcys is equivalent to 0.0585 ft/day or 21.36 ft/yr at 60° F. This value should be adjusted from 60° F to the formation temperature, but is sufficiently accurate as it is for this estimate. Now, from Equation 3-7:

$$v = \frac{21.36 \text{ ft/yr}}{0.104} \times \frac{10 \text{ ft/mile}}{5,280 \text{ ft/mile}} \\ = 0.39 \text{ ft/yr.}$$

This evaluation shows that water in the Mt. Simon Formation in north-central Ohio is moving northwest at a rate of 0.39 ft/yr. The source of the hydraulic gradient and the fate of the moving water are not understood. Furthermore, there are complications in the analysis itself, as pointed out by Bond (1973). However, in spite of such uncertainties, it can be indisputably concluded that water in the Mt. Simon Formation is moving at a negligible rate at this location. This fact is sufficient for a practical analysis of the monitoring needed at such a wastewater injection site.

As a further example, Figure 3-14 shows the potentiometric surface for the lower Floridan aquifer in northwest Florida. There the hydraulic gradient was about 1.33 ft/mile toward the southwest in the vicinity of the Monsanto Company injection well prior to its operation. The permeability is about one darcy and the porosity is estimated to be 10 percent (Goolsby, 1971 and 1972). The velocity of natural flow in the lower Floridan aquifer is then estimated to be

$$v = \frac{890 \text{ ft/yr}}{0.10} \times \frac{1.33 \text{ ft/mile}}{5,280 \text{ ft/mile}} = 2.24 \text{ ft/yr.}$$

This case is more easily interpreted than the previous one because it is known that the source of hydraulic head lies to the north of the injection well site and that the movement of water is to the south as shown in Figure 3-15. The velocity of flow, even in this case, is very low.

#### Pressure Effects of Injection --

Wastewater injected into subsurface reservoirs does not move into empty voids; rather it displaces existing fluids, primarily saline water. The displacement process requires exertion of some pressure, in excess of the natural



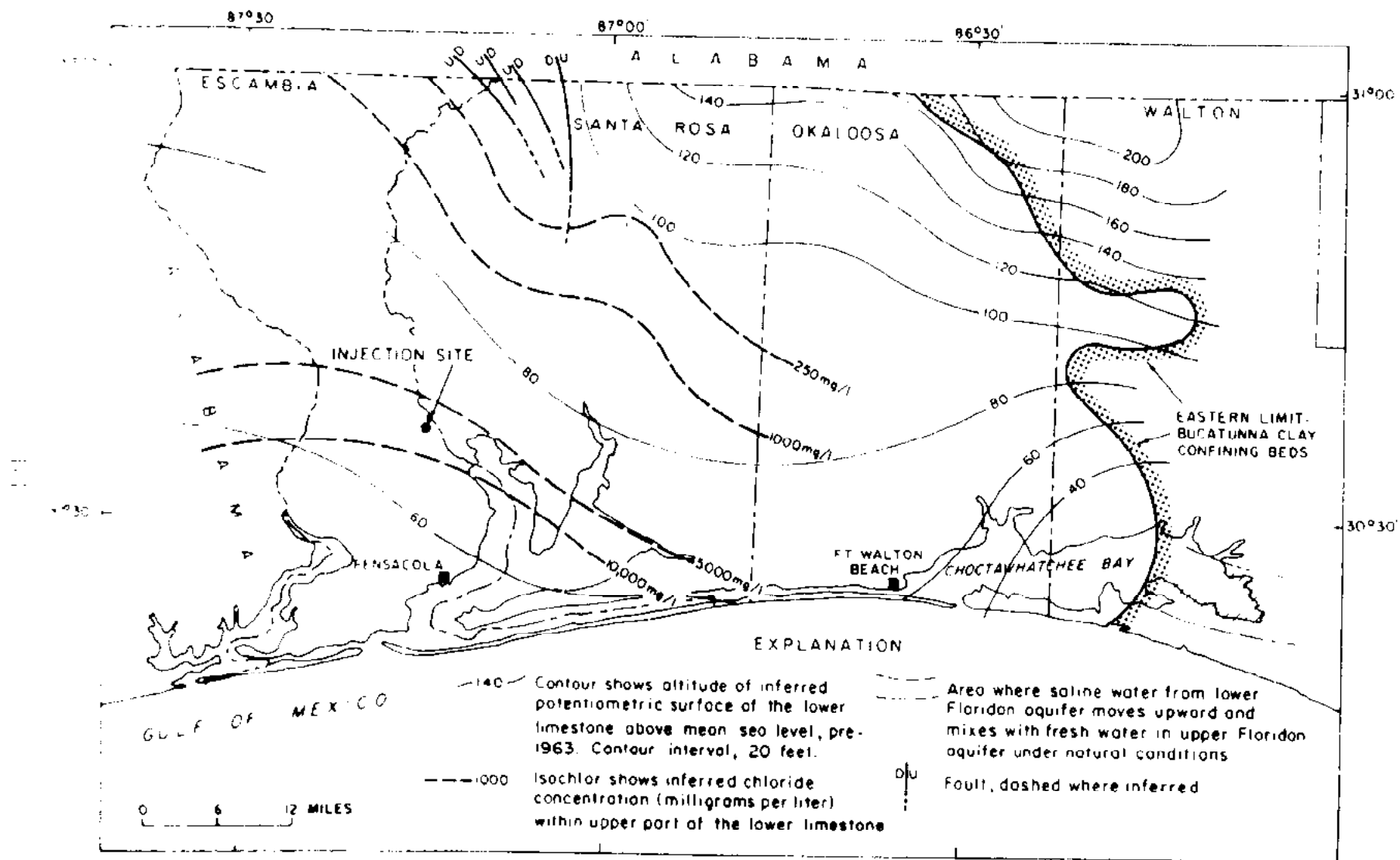

FIGURE 3-14. HYDROGEOLOGY OF THE LOWER FLORIDAN AQUIFER IN NORTHWEST FLORIDA (GOOLSBY, 1972).

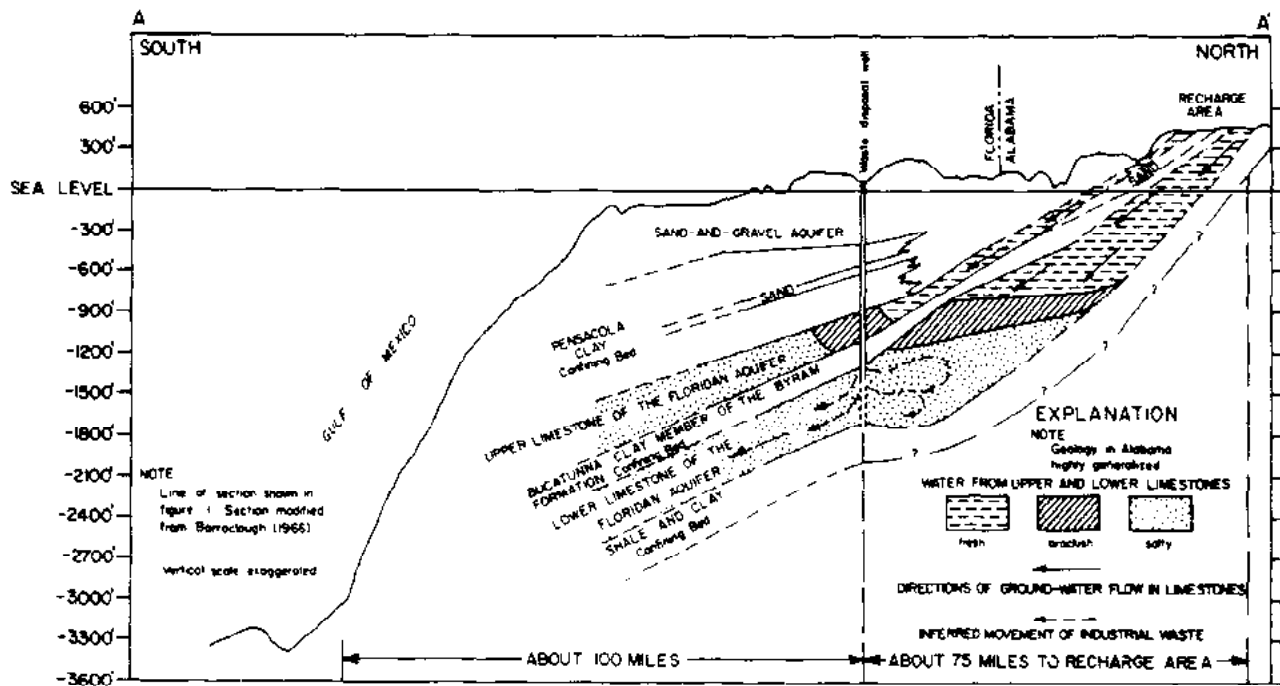

FIGURE 3-15. SOUTH-NORTH REGIONAL HYDROGEOLOGIC CROSS SECTION THROUGH THE MONSANTO COMPANY INJECTION SITE IN NORTHWEST FLORIDA (FAULKNER AND PASCALE, 1975).

formation pressure. The pressure increase is greatest at the injection well and decreases in approximately a logarithmic manner away from the well. The amount of excess pressure required and the distance to which it extends depend on the properties of the formation and the fluids, the amount of fluid being injected, and the length of time that injection has been going on. The pressure or head changes resulting from injection are added to the original regional hydraulic gradients to obtain a new potentiometric surface map that depicts the combined effects of regional flow and the local disturbances.

To compute the rate of pressure change in an injection interval, Darcy's law must be combined with the continuity equation so that time and the compressibility of the aquifer and aquifer fluids may be taken into account. The appropriate partial differential equation and its derivation may be found in most modern texts on hydrogeology and petroleum reservoir engineering, along with numerous solutions.

The solution first formulated and still most widely used for predicting the pressure effects of a well pumping from or injecting into an aquifer assumes the following conditions (Ferris, et. al., 1962; Kruseman and DeRidder, 1970; Lohman, 1972):

1. The aquifer is, for practical purposes, infinite in areal extent
2. The aquifer is homogeneous, isotropic, and of uniform thickness over the area of influence
3. Natural flow in the aquifer is at a negligible rate
4. The aquifer is sufficiently confined so that flow across confining beds is negligible
5. The well penetrates the entire thickness of the aquifer
6. The well is small enough that storage in the well can be neglected and water removed from or placed in storage in the aquifer is discharged or taken in instantaneously, with change in hydraulic head.

This is a formidable list of assumptions, which are obviously not completely met in any real situation. However, if one reviews the characteristics of many aquifers used for waste injection, water supply, and other purposes, it can be concluded that for practical purposes they probably comply sufficiently with the assumptions.

The equation that describes the response of such an aquifer to a single injection well is then (Ferris, et. al., 1962; Kruseman and DeRidder, 1970; Lohman, 1972):

$$\Delta h = \frac{Q}{4\pi T} \left( -0.577216 - \log_e u + u - \dots - \frac{u^2}{2 \cdot 2!} + \frac{u^3}{3 \cdot 3!} - \dots \right) \quad [L] \quad (3-8)$$

where

$$u = \frac{r^2 S}{4Tt} \quad [\text{dimensionless}]$$

and

$\Delta h$  = hydraulic head change at radius  $r$  and time  $t$

$Q$  = injection rate

$T$  = transmissivity

$S$  = storage coefficient

$t$  = time since injection began

$r$  = radial distance from well bore to point of interest.

One can easily enter the desired values into this series solution. Tables with the series evaluated are available in the previously referenced publications on aquifer testing. An analogous form of Equation 3-8, as used in petroleum reservoir engineering, is given by Matthews and Russell (1967).

For large values of time, small values of radius of investigation, or both, Equation 3-8 can be reduced to:

$$\Delta h = \frac{2.30Q}{4\pi T} \log \frac{2.25Tt}{r^2 S} \quad [L] \quad (3-9)$$

Equations 3-8 and 3-9 are not unitized; therefore, any consistent units can be used. The equation equivalent to 3-9, which is used in petroleum reservoir engineering is (Matthews and Russell, 1967):

$$\Delta p = \frac{162.6 Q\mu}{\bar{K}b} \left[ \log \frac{\bar{K}t}{\phi\mu cr^2} - 3.23 \right] \quad [\text{psi}] \quad (3-9a)$$

$\Delta p$  = reservoir pressure change at radius  $r$  and time  $t$  [psi]

$Q$  = injection rate [bbl/day]

$\mu$  = viscosity [centipoise]

$\bar{K}$  = average reservoir permeability [millidarcys]

- b = reservoir thickness [ft]
- t = time since injection began [hours]
- c = reservoir compressibility [psi<sup>-1</sup>]
- r = radial distance from well bore to point of interest [ft]
- φ = average reservoir porosity [decimal]

Two very important characteristics of the equations presented above are that individual solutions can be superimposed, and that hydrologic boundaries such as faults can be simulated by a properly located imaginary well. The fact that solutions can be superimposed allows the effects of multiple wells to be easily analyzed. Because the effect of boundaries is analogous to that of properly located pumping or injection wells, the existence of boundaries can be detected by observing aquifer response to injection or pumping or, conversely, the effects of known or suspected boundaries can be estimated.

Equations 3-8, 3-9, and many other similar solutions that are available for different assumed conditions are used to generate potentiometric surface maps showing anticipated conditions at a selected time in the future. The accuracy of the predicted effects is monitored as time passes and the predictions revised, if necessary, to better match actual aquifer performance.

Figure 3-16 shows the theoretical potentiometric surface map for the lower Floridan aquifer in northwest Florida in 1974, after wastewater injection had been in progress near Pensacola for about 11 years. The estimated pressure effects of injection can be seen by comparing the contours of the pre-injection potentiometric surface with the mid-1974 contours. The predicted effects have been partially verified by observation wells, the locations of which are also given in the figure.

As an example of the development of such a theoretical potentiometric surface map, one point in Figure 3-16 will be determined. The point will be one at a radial distance of seven miles northeast of the injection well site, which places it at a potential of about 80 feet on the pre-injection surface and 180 feet on the 1974 surface. From Goolsby (1972) and Faulkner and Pascale (1975) the following data were obtained or estimated:

- Q = 2.49 x 10<sup>6</sup> gal/day = 3.33 x 10<sup>5</sup> ft<sup>3</sup>/day
- T = 6,300 gal/day·ft = 842 ft<sup>3</sup>/day·ft
- t = 4,000 days
- r = 7 miles = 36,960 ft
- S = 2 x 10<sup>-6</sup> (dimensionless).

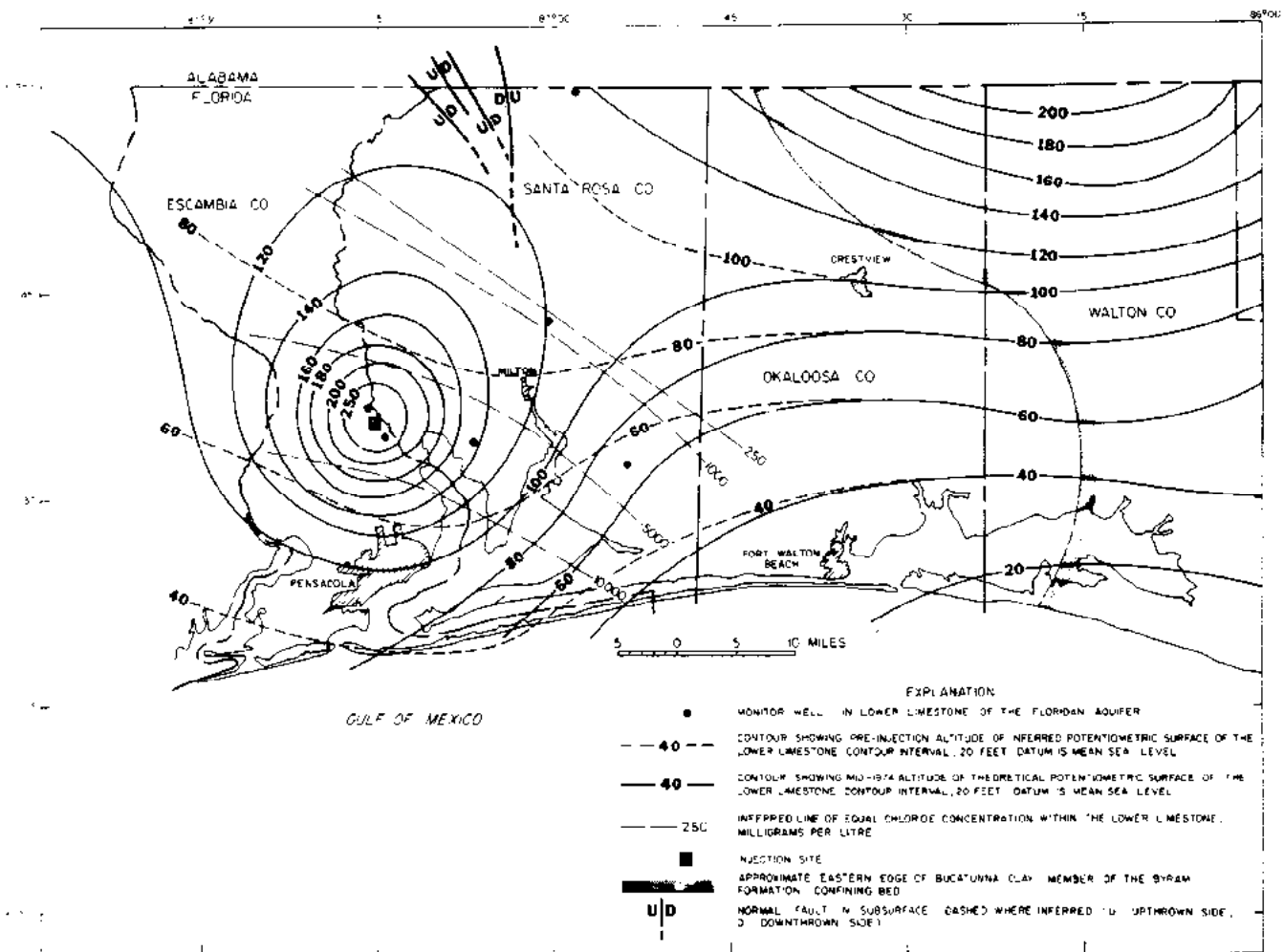

FIGURE 3-16. REGIONAL HYDROGEOLOGIC MAP SHOWING EFFECTS OF WASTE INJECTION BY MID-1974 ON THE POTENTIOMETRIC SURFACE OF THE LOWER LIMESTONE OF THE FLORIDAN AQUIFER (FAULKNER AND PASCALE, 1975).

Therefore, from Equation 3-9, the head increase in 4,000 days 7 miles northeast of the injection site is:

$$\begin{aligned} \Delta h &= \frac{2.30 \times 3.33 \times 10^5 \text{ ft}^3/\text{day}}{4\pi \times 842 \text{ ft}^3/\text{day}\cdot\text{ft}} \\ &\times \log \frac{2.25 \times 842 \text{ ft}^3/\text{day}\cdot\text{ft} \times 4,000 \text{ days}}{(36,960 \text{ ft})^2 \times 2 \times 10^{-4}} \\ &= 72.39 \log 27.74 = 104.5 \text{ ft.} \end{aligned}$$

The calculated increase of 104.5 feet compares well with the increase of 100 feet shown in Figure 3-16, when the accuracy of the map scale is considered. As many points as desired can be calculated to produce the contour map. Rather than calculating the pressure at a point (actually on a circle with radius  $r$ ) even head increments can be selected and the radii to them calculated, which simplifies the contouring process.

The most common use of Equation 3-9 and similar equations is to predict the pressure buildup that will occur during the planned lifetime of an injection well. This calculated pressure buildup is then compared with the allowable pressure buildup to determine if the injection will be feasible. As has been explained, prior to drilling a well, the formation properties necessary to perform this calculation are estimated. After the well has been drilled, they are obtained from core analyses and well testing.

As an illustration, assume a site for which the limiting well head pressure is 1,500 psi and the other conditions are:

$$Q = 1714.3 \text{ bbl/day (50 gpm)}$$

$$\mu = 1 \text{ centipoise}$$

$$\bar{K} = 50 \text{ millidarcys}$$

$$b = 45 \text{ ft}$$

$$t = 8.76 \times 10^4 \text{ hours (10 years - projected lifetime of the well)}$$

$$c = 7.5 \times 10^{-6} \text{ psi}^{-1}$$

$$r = 0.292 \text{ ft (3.5 inches - well radius)}$$

$$\gamma = 0.15$$

Using Equation 3-9a:

$$\Delta p = \frac{(162.6)(1714.3)(1)}{(50)(45)} \left[ \log \frac{(50)(8.76 \times 10^4)}{(0.15)(1)(7.5 \times 10^{-6})(.292)^2} - 3.23 \right]$$

$$\Delta p = 1,292 \text{ psi}$$

The calculation indicates that the anticipated pressure increase should be less than the limiting amount after ten years of injection at 50 gpm. The calculation is not sufficiently dependable to be relied upon to predict the exact lifetime of a well, but it gives the best indication available as to what should occur.

Multiple Wells-- As previously mentioned, estimating the combined pressure effects of multiple wells is made easy by virtue of the principle of superposition. It is only necessary to estimate the separate effects of two or more wells at the point of interest, then to add them to obtain their combined effect.

As an illustration of this, the effect of a second injection well located 1,000 feet from the well analyzed above will be computed. Assuming that the second well has the same characteristics as the first, the pressure at either well after 10 years of operation of both wells would be:

$$\Delta p = 1,292 \text{ psi} + \frac{(162.6)(1714.3)(1)}{(50)(45)} \dots$$

$$\dots \left[ \log \frac{(50)(8.76 \times 10^4)}{(0.15)(1)(7.5 \times 10^{-6})(1,000)^2} - 3.23 \right]$$

$$\Delta p = 1,292 \text{ psi} + 416 = 1,708 \text{ psi}$$

The calculation indicates that it would probably not be possible to operate the two wells at 50 gpm 1,000 feet apart for 10 years, since the injection pressure at each well would build up to 1,708 psi, which exceeds the allowable 1,500 psi. Van Everdingen (1968) presents other examples of such calculations for injection wells.

Hydrologic Discontinuities -- Another common situation is one in which a barrier to flow, a fault or facies change, is present within the area of influence of an injection well. Faults may also act as channels for escape of fluid from the injection horizon.

In predicting aquifer response in the presence of such features, the image-well concept is used. Assume the presence of a fault or lithologic change that acts as an impermeable barrier, 500 feet in any direction from the Mt. Simon Formation injection well that is discussed above. Then, according to image-well theory, an imaginary injection well with all of the same properties as the real injection well is placed 1,000 feet from the real well, on the opposite side of the fault and on a line that passes



through the real well and is perpendicular to the fault. Figure 3-17 shows the potentiometric surface and flow lines that would develop in such a situation; the pressure effect of the barrier would be the same as that calculated above for an actual injection well 1,000 feet from the first well.

If the hydrologic discontinuity were a leaky fault rather than a sealed one, the opposite effect would occur; the pressure at any time would be reduced as if a discharging well were present.

The equations and examples given are for the most basic hydrogeologic circumstances, but many injection wells can be treated this way because these are the conditions sought when choosing an injection site and receiving aquifer. However, cases of virtually any complexity can be analyzed by use of the appropriate solution to the basic flow equations; where analytical solutions are not possible, numerical models can be developed. The limitations to an analysis are usually pragmatic rather than theoretical--lack of data, limitations of time and funds, or the fact that a simplified estimate is sufficient for the circumstances.

#### Rate and Direction of Wastewater Movement --

As with pressure response to injection, the rate and direction of movement of the injected fluid depend on the hydrogeology of the site; therefore, the same factors previously listed require consideration. In addition, the properties of the formation water and the injected wastewater assume major importance.

Broad flow patterns in an aquifer with a significant existing potentiometric gradient can be deduced from a map of the regional potentiometric surface with the effects of the injection system superimposed.

Figure 3-18 is a duplication of Figure 3-16, with flow lines added to show how the flow directions of formation water and injected wastewater can be deduced from the potentiometric surface map. The wastewater will never actually travel as far northward as the map indicates, but displaced formation water will be forced in this direction, ahead of the small cylinder of wastewater that surrounds the well. The extent of this wastewater cylinder will be discussed next.

A good estimate of the minimum distance of wastewater flow from an injection well can be made by assuming that the wastewater will uniformly occupy an expanding cylinder with the well at the center. The equation for this case is:

$$r = \sqrt{\frac{V}{\pi b}} \quad [L] \quad (3-10)$$

where

$r$  = radial distance of wastewater front from well

$V = Qt$  = cumulative volume of injected wastewater

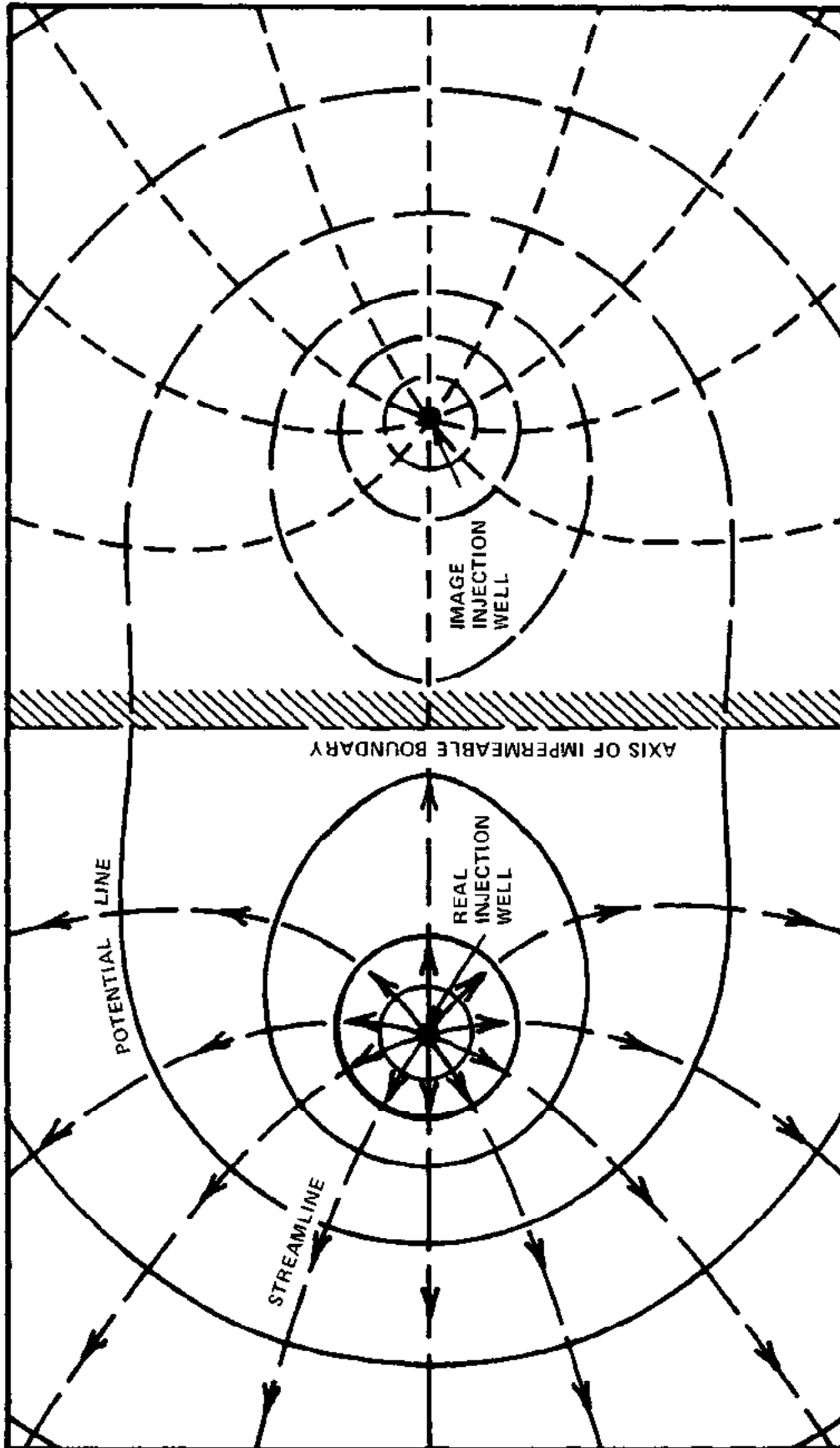

FIGURE 3-17. GENERALIZED FLOW NET SHOWING THE POTENTIAL LINES AND STREAM LINES IN THE VICINITY OF AN INJECTION WELL NEAR AN IMPERMEABLE BOUNDARY (FERRIS ET. AL., 1962).

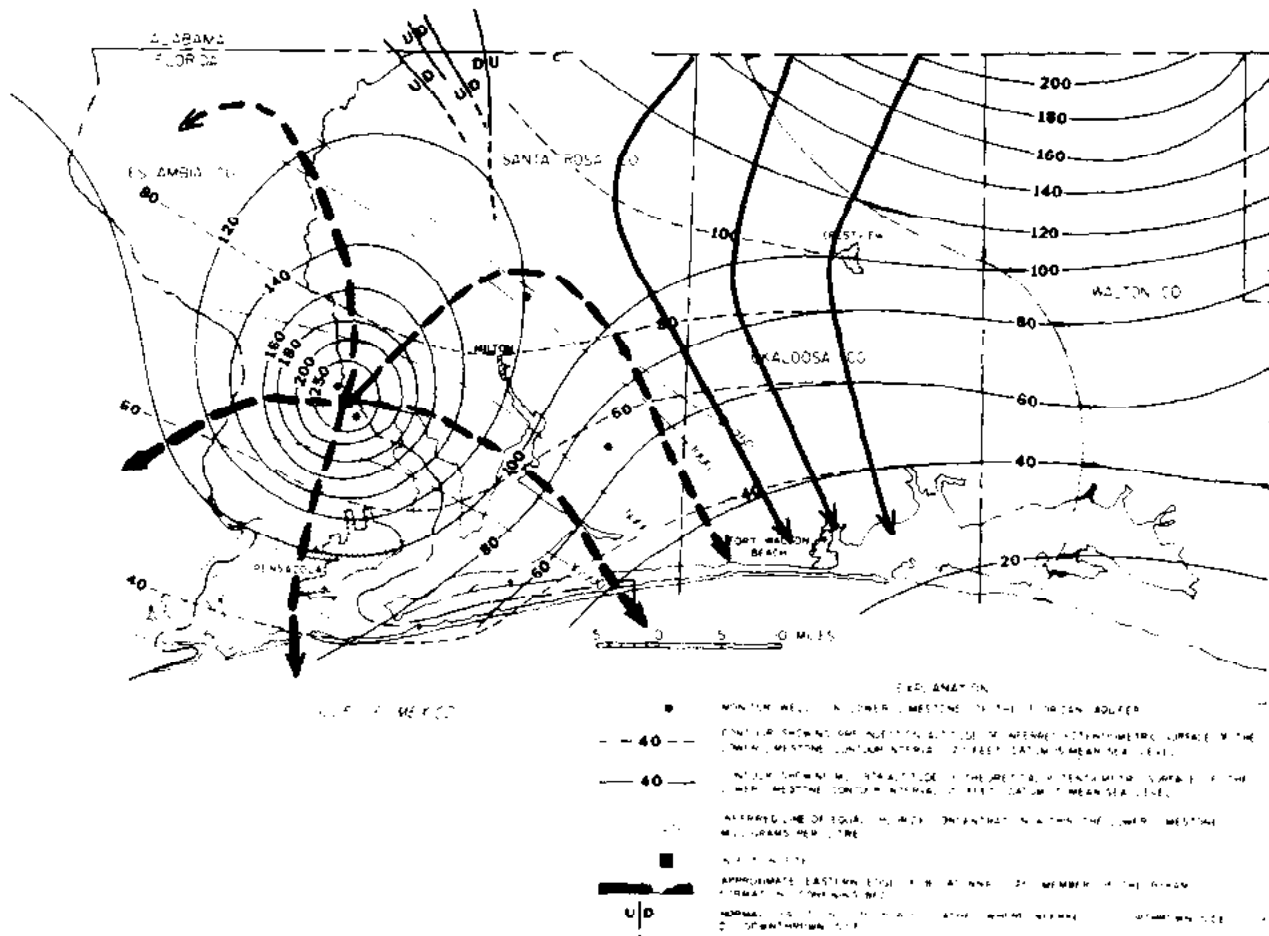

FIGURE 3-18. THEORETICAL POTENTIOMETRIC SURFACE OF LOWER LIMESTONE OF FLORIDAN AQUIFER IN MID-1974, WITH FLOW LINES SHOWING THE DIRECTIONS OF AQUIFER WATER AND WASTEWATER MOVEMENT. SOLID FLOW LINES SHOW THE DIRECTION OF FLOW OF DIVERTED AQUIFER WATER, DASHED FLOW LINES SHOW DIRECTION OF FLOW OF INJECTED WASTEWATER AND DISPLACED AQUIFER WATER (MODIFIED AFTER FAULKNER AND PASCALE, 1975).

b = effective reservoir thickness

$\phi$  = average effective porosity.

For an injection well with the following characteristics:

Q = 100 gpm

t = 5 years

b = 1618 feet

$\phi$  = 13.5 percent

$$r = \sqrt{\frac{35,128,993 \text{ ft}^3}{\pi \times 1618 \text{ ft} \times 0.135}}$$
$$= 226 \text{ ft}$$

It is noted that effective reservoir thickness and average effective porosity should be used. The effective reservoir thickness, for example, is that part of the total reservoir that consists of sandstone (in the case of a mixed sandstone-shale lithology.) The effective porosity has been previously defined as that part of the porosity in which the pores are interconnected.

In most situations the minimum radial distance of travel will be exceeded, because of dispersion, density segregation, and channeling through high permeability zones. Flow may also be in a preferred direction, rather than radial, because of hydrologic discontinuities (e.g., faults), selectively oriented permeability paths, or natural flow gradients.

An estimate of the influence of dispersion can be made with the following equation:

$$r' = r + 2.3 \sqrt{Dr} \quad [L] \quad (3-11)$$

where

r' = radial distance of travel with dispersion

D = dispersion coefficient; 3 ft for sandstone aquifers and 65 feet for limestone or dolomite aquifers.

Equation 3-11 is obtained by solving equation (10.6.65) of Bear (1972) for the radial distance at which the injection front has a chemical concentration of 0.2 percent of the injected fluid. The detailed development of dispersion theory is presented by Bear (1972). The dispersion coefficients given are high values for sandstone and limestone aquifers obtained from the literature.

No actual dispersion coefficients are known to have been obtained for any existing injection well.

Then for the above example, which is a sandstone:

$$\begin{aligned}r' &= 226 \text{ ft} + 2.3 \sqrt{3 \text{ ft} \times 226 \text{ ft}} \\ &= 286 \text{ ft}.\end{aligned}$$

It is clear that, in this example, the distance of wastewater travel from the well is negligible and could not possibly be of concern if actual conditions comply even generally with those that were assumed. This conclusion has been found to apply to many of the wells that have been constructed to date. Since almost no attempts have been made to determine the actual wastewater distribution around existing injection wells, there is little evidence for comparison with theory. However, if such a calculation were in error by several hundred percent, there would still be no cause for concern, since the injection well, in this and many other cases, is tens of miles from the nearest well penetrating the injection zone.

To proceed beyond the calculations that have been shown may not be necessary or, in many cases, meaningful. However, it may be possible, if necessary, to account for some of the additional complications that are mentioned. For example, Bear and Jacobs (1964), in one of a series of reports, considered the flow of water from a groundwater recharge well in an aquifer of uniform flow, when the densities and viscosities of the injected and interstitial fluids are the same. Gelhar et. al. (1972) developed analytical techniques for describing the mixing of injected and interstitial waters of different densities. Kazman (1974) discussed the use of an aquifer model for verification of complex waste flow patterns.

So far, the travel of the injected wastewater has been treated as though it were an inert fluid whose constituents would not react with the aquifer water or minerals, be affected by bacterial action, or decompose or radioactively decay. If the wastewater is not inert, then changes in chemical composition with time and distance may also need to be considered. Bredehoeft and Pinder (1972) discuss the methodology for a unified approach to this type of problem. Robertson and Barraclough (1973) present an example of a case in which radioactive decay, dispersion, and reversible sorption were considered, and Intercomp Resource Development and Engineering, Inc. (1976) provides a description of and the computer program for a transient, three-dimensional digital model that simulates wastewater movement from an injection well. The Intercomp model accounts for density and viscosity variations resulting from temperature and compositional changes and includes the effects of hydrodynamic dispersion in producing compositional changes. However, no procedure exists at this time for simultaneously considering the full range of practical possibilities that may be involved in wastewater movement.

In spite of the degree of sophistication used in development of the curves for rate and direction of travel of injected fluid from an injection

well, nonuniform distribution of porosity and permeability will preclude making accurate estimates in many cases. In general, wastewater flow in unfractured sand or sandstone aquifers would be expected to more closely agree with theory than flow in fractured reservoirs or in carbonate aquifers with solution permeability. However, even in sand aquifers, flow can be expected to be nonideal as shown by tests reported by Brown and Silvey (1973). Particularly great deviations from predictions may occur in limestone or dolomite aquifers. Figure 3-19 is an example of this. The radial zones around Well No. 1 show the predicted extent of waste travel using Equations 3-10 & 3-11. The irregular boundary shows the probable actual extent of wastewater spread as indicated by evidence from Wells 2 and 3. In this case, the wastewater apparently traveled selectively in a single thin porous and permeable interval rather than throughout the several zones indicated by testing results. Accurate prediction of the rate and direction of movement in such a case may well be technically infeasible even in the future because the amount of information needed will seldom, if ever, be available.

#### Hydraulic Fracturing --

Hydraulic fracturing may be deliberately accomplished to increase formation receptivity or apparent permeability. It may occur during injection testing or wastewater injection if the fracture initiation pressure is exceeded.

Regulatory policy may or may not allow short-term hydraulic fracturing operations for well stimulation, but continuous injection at pressures above the fracture point are prohibited by most, if not all, agencies. This is because of the danger of damage to well facilities and because of the uncertainty about where the fractures and injected fluids are going if fractures continue to be extended. In order to produce and propagate a hydraulic fracture that will achieve increased well receptivity, large amounts of pump power, effective fluid loss control additives, and propping agents such as sand, are desirable. Fractures may not propagate in normally permeable rocks unless the fracture surfaces are continually sealed by the injected fluid. In practice a fluid loss control agent that later breaks down and becomes inoperative is employed to assist fracture propagation.

Figure 3-20 is a schematic diagram of bottom-hole pressure and surface pressure versus time during hydraulic fracturing. Before injection begins, the pressure is that of the formation fluid ( $p_0$ ) and the column of fluid in the well bore. Pressure is increased until fracturing occurs; then, as fluid continues to be pumped into the well, the pressure stabilizes at  $p_f$ , the flowing pressure, during which the fractures continue to be extended. When injection is ceased, and the well shut in, the pressure quickly stabilizes to a constant value, the instantaneous shut-in pressure. This pressure is considered to be equal to the least principal earth stress in the vicinity of the well.

In estimating the fluid pressure at which hydraulic fracturing will occur, one of two conditions is usually assumed:

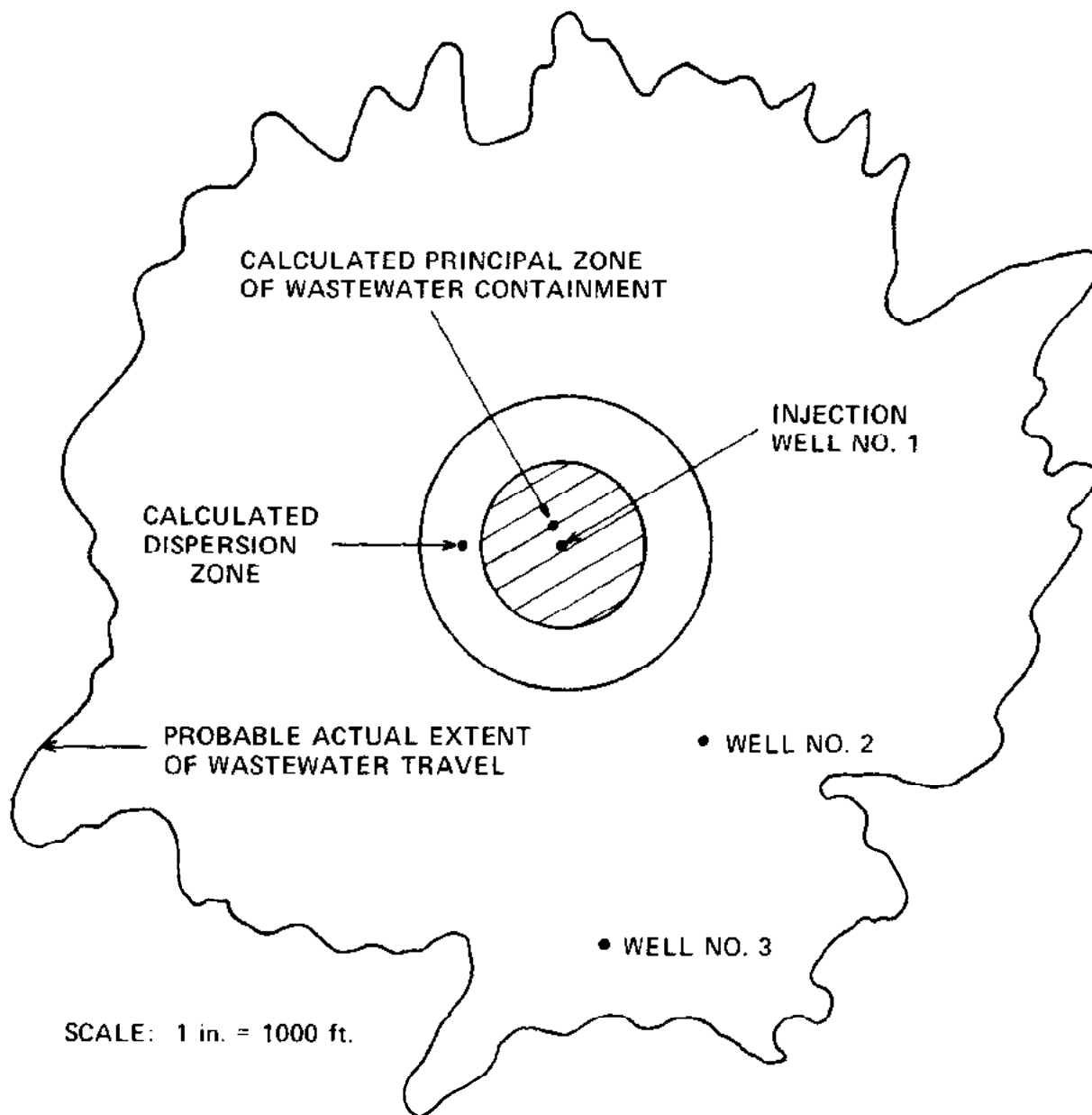

FIGURE 3-19. PREDICTED AND PROBABLE ACTUAL EXTENT OF WASTEWATER TRAVEL FOR A WELL COMPLETED IN A CARBONATE RESERVOIR.

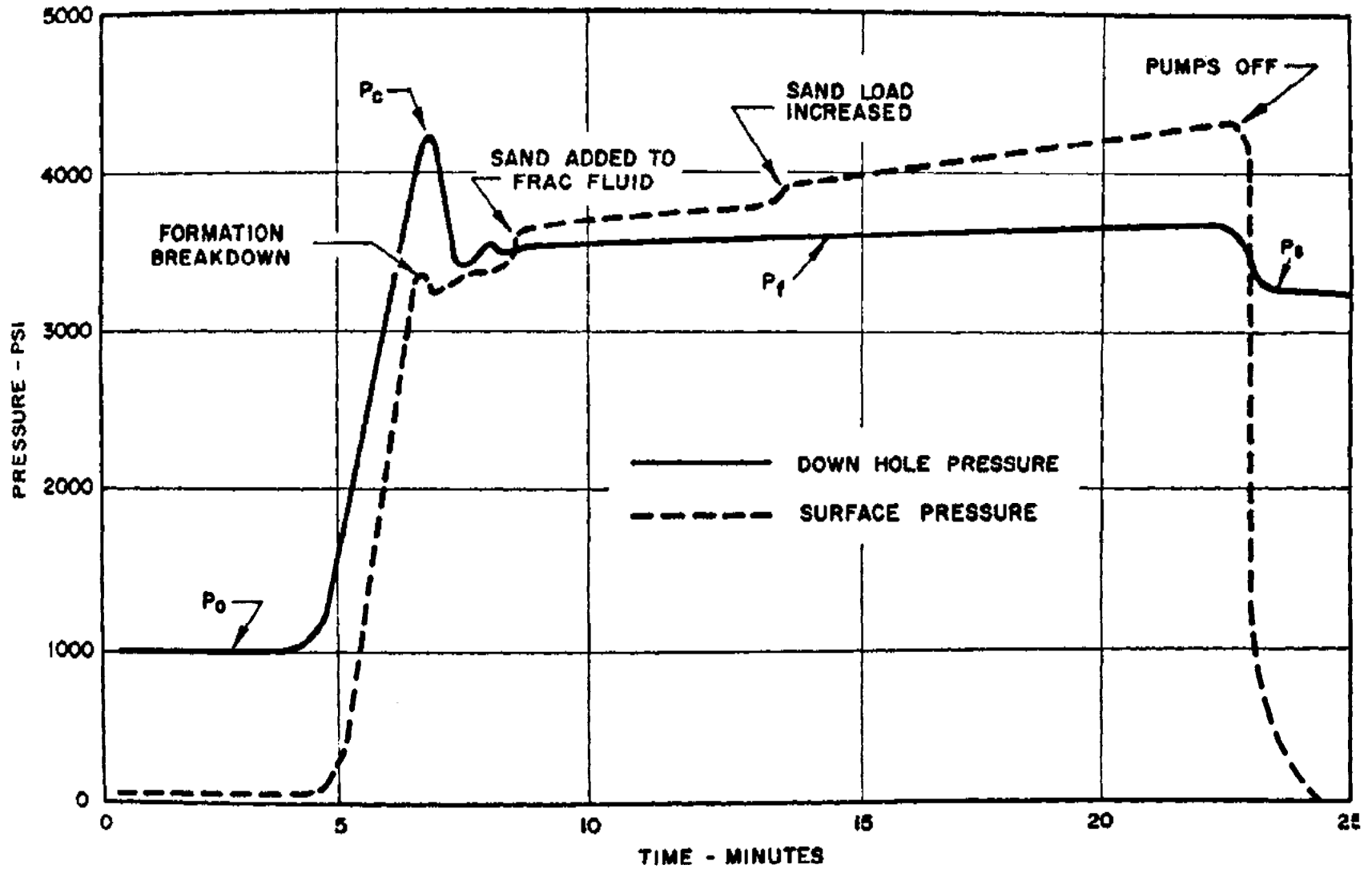

FIGURE 3-20. SCHEMATIC DIAGRAM OF PRESSURE VERSUS TIME DURING HYDRAULIC FRACTURING (KEHLE, 1964).



1. That the least principal stress is less than the vertical lithostatic stress caused by the rock column. In this case fractures are assumed to be vertical.
2. That the vertical lithostatic stress is the least principal stress. In this case fractures will be horizontal.

In the first case, the minimum bottom-hole pressure required to initiate a hydraulic fracture can be estimated from (Hubbert & Willis, 1972):

$$p_i = \frac{S_z + 2p_0}{3} \quad (F/L^2) \quad (3-12)$$

where

$p_i$  = fracture initiation pressure

$S_z$  = total lithostatic stress

$p_0$  = formation fluid pressure

The hydraulic fracturing gradient, that is, the injection pressure required per foot of depth to initiate hydraulic fractures, can be estimated by entering representative unit values into Equation 3-12. The unit values for  $S_z$  and  $p_0$  are, respectively, 1.0 and 0.46 psi/ft. This yields a  $p_i$  gradient of 0.64 psi/ft as a minimum value for initiation of hydraulic fractures. This situation implies a minimum lateral earth stress. As the lateral stresses increase, the bottom-hole fracture initiation pressure also increases up to a limiting value of 1.0 psi/ft. Actually, fracture pressures may exceed 1.0 psi/ft when the rocks have significant tensile strength and no inherent fractures that pass through the well bore.

In any particular case, injection tests can be run on the well to determine what the actual fracture pressure is. Operating injection pressures are then held below the instantaneous shut-in pressure measured immediately following injection of fracture pressures. In the absence of any specific data, arbitrary limitations of from 0.5 to 1.0 psi per foot of depth have been imposed on operating injection wells. Regional experience should be used as a criterion in establishing an arbitrary limit, since regional tectonic conditions and fluid pressure gradients dictate what a safe limit will be.

A recent series of field experiments were performed in the Piceance Basin of northwest Colorado to test the validity of the concepts discussed above and to determine the state of rock stress in that area (Wolff, et. al., 1975; Bredehoeft, et. al., 1976). The conclusions reached were consistent with theory. The area was found to be tectonically relaxed and vertical fractures were generated at about two thirds of the overburden pressure, as would be predicted from Equation 3-12.

## Earthquake Triggering --

As a matter of background, it is widely, but not universally, accepted that a series of earthquakes that began in the Denver area in 1962 was initiated by injection of wastewater into a well at the Rocky Mountain Arsenal. Since the association of seismic activity with wastewater injection at Denver, apparently similar situations have been observed at Rangely, Colorado, and Dale, New York. The former related to water injection for secondary recovery of oil and the latter to disposal of brine from solution mining of salt. On the other hand, there are presently about 160 operating industrial wastewater injection wells and tens of thousands of oil field brine disposal wells that have apparently never caused any noticeable seismic disturbance, so these three examples would have to be considered very rare.

It has been erroneously stated by many that the seismic events have been stimulated by "lubrication" of a fault zone by injected fluids. What has happened, if injection has been involved, is that the water pressure on a fault surface has been increased, thus decreasing the friction on that surface and allowing movement and consequent release of stored seismic energy.

Based on this interpretation of the mechanism of earthquake triggering by fluid injection, some of the conditions that would have to exist in order to have such earthquakes would be:

1. A fault with forces acting to cause movement of the blocks on either side of the fault surface, but which are being successfully resisted by frictional forces on the surface.
2. An injection well that is constructed close enough, vertically and horizontally, to the fault so that the fluid pressure changes caused by injection will be transmitted to the fault plane.
3. Injection at a sufficiently great rate and for a sufficiently long time to increase fluid pressure on the fault plane to the point that frictional forces resisting movement become less than the forces tending to cause movement. At this time, movement will occur and stored seismic energy will be released. That is, an earthquake will occur.

As has been discussed earlier in the section on state of stress, relatively little is known about stress distribution in the earth's crust and even less is known about stress distribution along fault systems. In the absence of this information, only qualitative estimates of the probability of earthquake stimulation can be made. In the great majority of cases the potential for earthquake stimulation will be nonexistent or negligible because only very limited areas in the country are susceptible to earthquake occurrence. The susceptible areas are delineated by records of earthquakes that have occurred in the past and by tectonic maps that show geologic features which are associated with belts of actual or potential earthquake activity.

In a case where subsurface stresses are known or are determined by hydraulic fracturing or other means, and where the location and orientation of the fault plane are known, then a quantitative estimate of the pressure required to cause fault movement can be made. Raleigh (1972) provides an example of such a calculation from the Rangely, Colorado, oil field.

## REFERENCES

### CHAPTER 3

- American Geological Institute. Glossary of Geology and Related Sciences. 2nd ed. Washington, D. C. 1976.
- American Petroleum Institute. Recommended Practice for Core Analysis Procedure. API RP-40, Dallas, TX. 1960.
- Bear, Jacob. Dynamics of Fluids in Porous Media. Elsevier Publishing Co., New York. 1972. 764 pp.
- Bear, J., and Jacobs, M. The Movement of Injected Water Bodies in Confined Aquifers. Underground Water Storage Study Report No. 13, Technion, Haifa, Israel. 1964.
- Bond, D. C. "Deduction of Flow Patterns in Variable-Density Aquifers from Pressure and Water-Level Observations." in Underground Waste Management and Artificial Recharge. Jules Braunstein, ed. American Assoc. Petroleum Geologists, Tulsa, Oklahoma. 1973. pp. 357-378.
- Bredehoeft, J. D., et. al. "Hydraulic Fracturing to Determine the Regional In Situ Stress Field, Piceance Basin, Colorado." Geol. Soc. of Amer. Bull. Vol. 87. 1976. pp. 250-258.
- Bredehoeft, J. D., and Pinder, G. F. "Application of Transport Equations to Groundwater Systems." in Underground Waste Management and Environmental Implications. T. D. Cook, ed. Amer. Assoc. Petroleum Geologists Memoir 18. 1972. pp. 191-199.
- Brown, D. L., and Silvey, W. D. "Underground Storage and Retrieval of Fresh Water from a Brackish-Water Aquifer." in Underground Waste Management and Artificial Recharge. Jules Braunstein, ed. Amer. Assoc. of Petroleum Geologists. Tulsa, Oklahoma. 1973. pp. 379-419.
- Clifford, M. J. "Hydrodynamics of the Mount Simon Sandstone, Ohio and Adjoining Areas." in Underground Waste Management and Artificial Recharge. Jules Braunstein, ed. American Assoc. of Petroleum Geologists, Tulsa, Oklahoma. 1973. pp. 349-356.
- Dobrin, M. B. Introduction to Geophysical Prospecting. McGraw-Hill Book Company, New York. 1976.

- Edwards, A. G., and Winn, R. H. A Summary of Modern Tools and Techniques Used in Drill Stem Testing. Presented at the dedication of the U. S. East-West Trade Center, Vienna, Austria, June 14-17, 1973. Available from Halliburton Services, Duncan, Oklahoma. 1974. 31 pp.
- Faulkner, G. L., and Pascale, C. A. "Monitoring Regional Effects of High Pressure Injection of Industrial Waste Water in a Limestone Aquifer." Ground Water. Vol. 13, No. 2. 1975. pp. 197-208.
- Ferris, J. G., et. al. Theory of Aquifer Tests. U. S. Geological Survey Water Supply Paper 1536-E. 1962. 174 pp.
- Gatlin, Carl. Petroleum Engineering Drilling and Well Completions. Prentice-Hall, Inc., Englewood Cliffs, N. J. 1960.
- Gelhar, L. W., et. al. Density Induced Mixing in Confined Aquifers. U. S. Environmental Protection Agency Water Pollution Control Research Series Publication 16060 ELJ 03/72. 1972.
- Haun, J. D., and LeRoy, L. W., eds. Subsurface Geology in Petroleum Exploration, Colorado School of Mines, Golden, Colorado. 1958.
- Hubbert, M. K., and Willis, D. G. "Mechanics of Hydraulic Fracturing." in Underground Waste Management and Environmental Implications. T. D. Cook, ed. Amer. Assoc. of Petroleum Geologists Memoir 18. Tulsa, Oklahoma. 1972. 411 pp.
- Jennings, H. Y., and Timur, A. "Significant Contributions in Formation Evaluation and Well Testing." Journal Petroleum Technology. Vol. 25. December, 1973. pp. 1432-1446.
- Kazmann, Raphael. "Waste Surveillance in Subsurface Disposal Projects." Ground Water. Vol. 12, No. 6. 1974. pp. 418-426.
- Kehle, R. O. "The Determination of Tectonic Stresses through Analysis of Hydraulic Well Fracturing." Journal Geophysical Research. Vol. 69. No. 2. 1964. pp. 259-273.
- Keys, W. S., and Brown, R. F. "Role of Borehole Geophysics in Underground Waste Storage and Artificial Recharge." in Underground Waste Management and Artificial Recharge. Jules Braunstein, ed. Amer. Assoc. of Petroleum Geologists, Tulsa, Oklahoma. 1973. pp. 147-191.
- Kirkpatrick, C. W. "Formation Testing." The Petroleum Engineer. 1964. pp. 8-133.

- Kruseman, G. P., and DeRidder, N. A. Analysis and Evaluation of Pumping Test Data. International Institute for Land Reclamation and Improvement. Bulletin 11. Wageningen, The Netherlands. 1970. 200 pp.
- Lohman, S. H. Ground-Water Hydraulics. U. S. Geol. Survey Professional Paper 708. 1972. 70 pp.
- Lynch, E. J. Formation Evaluation. Harper and Rowe, New York, New York. 1962. 422 pp.
- Matthews, C. S., and Russell, D. G. Pressure Buildup and Flow Tests in Wells. American Institute of Mining, Met. Eng. Monograph, Vol. 1. 1967.
- Murphy, W. C. "The Interpretation and Calculation of Formation Characteristics from Formation Test Data." Halliburton Services, Duncan, Oklahoma. undated.
- Pirson, S. J. Handbook of Well Log Analysis. Prentice-Hall Inc., Englewood Cliffs, N. J. 1963. 326 pp.
- Raleigh, C. B. "Earthquakes and Fluid Injection." in Underground Waste Management and Environmental Implications. T. D. Cook, ed. American Assoc. of Petroleum Geologists Memoir 18. 1972. pp. 273-279.
- Robertson, J. B., and Barraclough, J. T. "Radioactive-and-Chemical-Waste Transport in Groundwater at National Reactor Testing Station, Idaho: 20-year Case History and Digital Model." in Underground Waste Management and Artificial Recharge. Jules Braunstein, ed. Amer. Assoc. Petroleum Geologists, Tulsa, Oklahoma. 1973. pp. 291-322.
- Schlumberger Limited. Log Interpretation Volume I - Principles. Schlumberger Limited, New York, New York. 1972.
- Schlumberger Limited. Log Interpretation Charts. Schlumberger Limited, New York, New York. 1972a.
- Tucker, W. E., and Kidd R. E. Deep Well Disposal in Alabama. Geological Survey of Alabama. Geological Survey of Alabama Bulletin 104. 1973.
- Van Everdingen, A. F. "Fluid Mechanics of Deep-Well Disposals." in Sub-surface Disposal in Geologic Basins - A Study of Reservoir Strata. J. E. Galley, ed. American Assoc. Petroleum Geologists Memoir 10. 1968. pp. 32-42.
- Wilson W. E., et. al. "Hydrologic Evaluation of Industrial-Waste Injection at Mulberry, Florida." in Underground Waste Management and Artificial Recharge. Jules Braunstein, ed. American Assoc. Petroleum Geologists, Tulsa, Oklahoma. 1973. pp. 552-564.
- Witherspoon, P. A., et. al. Interpretation of Aquifer Gas Storage Conditions from Water Pumping Tests. American Gas Association, Inc., New York, New York. 1967. 273 pp.

- Witherspoon, P. A., and Neuman, S. P. "Hydrodynamics of Fluid Injection."  
in Underground Waste Management and Environmental Implications.  
T. D. Cook, ed. American Assoc. Petroleum Geologists Memoir 18, Tulsa,  
Oklahoma. 1972.
- Wolff, R. G., et. al. "Stress Determination by Hydraulic Fracturing in Sub-  
surface Waste Injection." American Water Works Association Journal.  
Vol. 67. 1975. pp. 519-523.

## CHAPTER 4

### CRITERIA FOR INJECTION WELL SITE EVALUATION

The geologic and hydrologic information necessary for evaluation of an injection well site and the means of obtaining this information before and during well construction have been discussed in the previous two chapters. In this chapter, a procedure for using this information in determining the suitability of a site for wastewater injection is outlined and the criteria for a suitable site discussed.

As was indicated in Chapter 2, examination of a site for a wastewater injection well begins at the regional level, then is narrowed to the vicinity of the site, and finally focuses upon the immediate well location. Table 4-1 lists the factors important to regional and local site evaluation.

#### REGIONAL EVALUATION

Figure 4-1, presented by Van Everdingen and Freeze (1971), is a flow diagram that shows a procedure for the regional evaluation of an injection well site. The yes-no statements in the flow diagram are oversimplified; but, in concept, the diagram represents the procedure that is followed, whether consciously or not, in such evaluations.

Ideally suitable regions for subsurface wastewater injection should satisfy the following criteria:

- a. An extensive, thick sedimentary sequence should be present, to provide opportunity for an adequate injection interval and confining strata.
- b. Geologic structure should be relatively simple, that is, the region should be reasonably free of complex and extensive faulting and folding. Complex geologic structure complicates prediction and monitoring of waste travel and faults are possible avenues of wastewater escape.
- c. Possible injection intervals should contain saline water and should not be abundantly endowed with mineral resources (oil, gas, coal, etc.), so that the potential for degradation of natural resources is minimized.



TABLE 4-1. FACTORS TO BE CONSIDERED FOR GEOLOGIC AND HYDROLOGIC EVALUATION OF A SITE FOR SUBSURFACE WASTE INJECTION

---

---

Regional Geologic and Hydrologic Framework

Physiography and general geology; structure; stratigraphy; ground water; mineral resources; seismicity; hydrodynamics

Local Geology and Geohydrology

- A. Structural Geology
- B. Geologic Description of Subsurface Rock Units
  1. General rock types and characteristics
  2. Description of injection horizons and confining beds. Lithology; thickness and vertical and lateral distribution; porosity (type and distribution as well as amount); permeability (same as for porosity); reservoir temperature and pressure; chemical characteristics of reservoir fluids; formation breakdown or fracture pressure; hydrodynamics.
  3. Fresh water aquifers at the site and in the vicinity. Depth; thickness; general character; quality of contained water; amount of use and potential for use.
  4. Mineral resources and their occurrence at the well site and in the immediate area. Oil and gas (including past, present and possible future development); coal; brines; other.

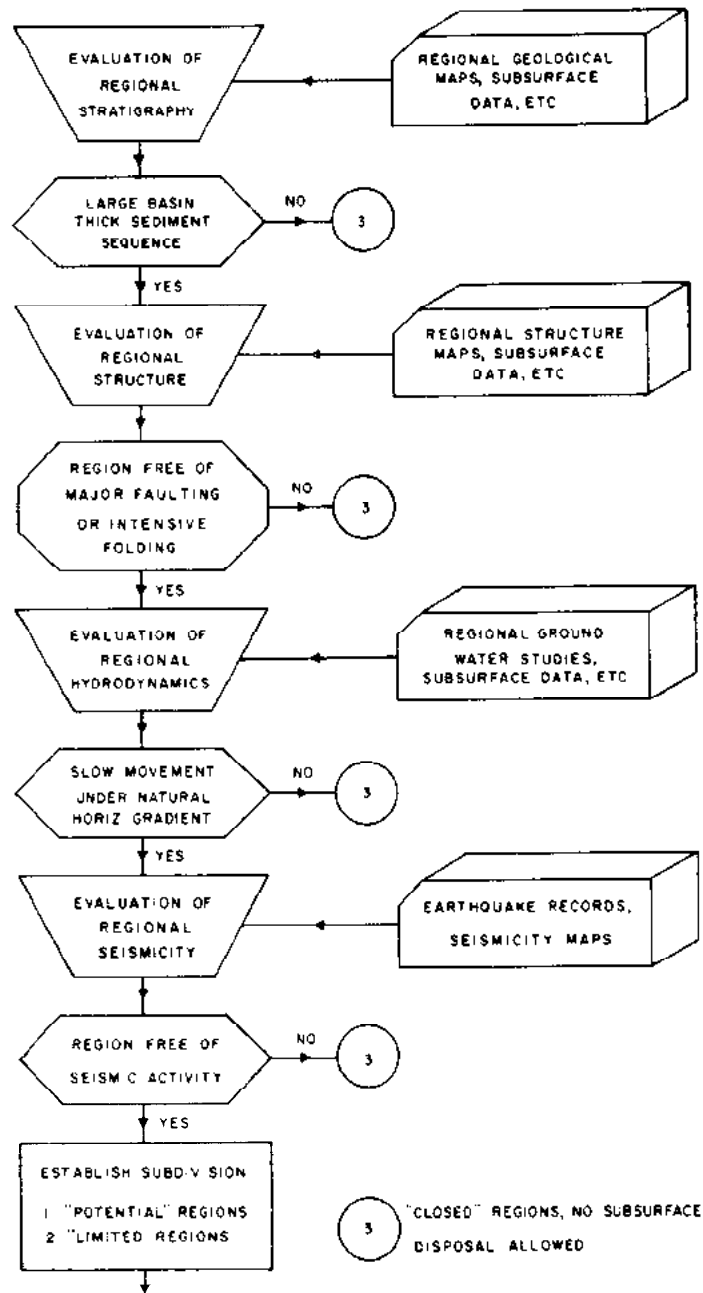

FIGURE 4-1. EVALUATION OF REGIONS FOR SUBSURFACE WASTEWATER INJECTION (VAN EVERDINGEN AND FREEZE, 1971).

- d. Fluid flow in possible injection intervals should be negligible or at low rates, and the region should not be an area of ground water discharge for the injection intervals being considered.
- e. The region should preferably not be one of high seismic risk, nor should it be a seismically active one. Earthquakes may damage injection facilities and, in seismically active area, injection may stimulate earthquakes.

The criteria used in a regional evaluation are perhaps best discussed by application to an example. For this purpose, the entire conterminous United States can be subjected to a superficial evaluation, which is useful as a starting point for a more detailed analysis.

Synclinal sedimentary basins and the Atlantic and Gulf Coastal Plains (Figure 4-2) are particularly favorable sites for waste-injection wells because they contain relatively thick sequences of salt-water-bearing sedimentary rocks and because commonly the subsurface geology of these basins is relatively well known. Galley (1968) discussed general aspects of geologic basin studies as related to deep-well disposal of radioactive waste.

During the early 1960's a series of reports concerning the suitability of selected basins for radioactive waste disposal was prepared for the Atomic Energy Commission by the U. S. Geological Survey. These reports included ones by Repenning (1961) on the Central Valley of California, Sandberg (1962) on the Williston basin, Beikman (1962) on the Powder River basin, MacLachlan (1964) on the Anadarko basin, LeGrand (1962) on the Atlantic and Gulf Coastal Plain, and Colton (1961) on the Appalachian basin; Love and Hoover (1960) briefly summarized the geology of many sedimentary basins in the United States.

In addition to the USGS basin reports, members of a subcommittee of the Research Committee of the American Association of Petroleum Geologists prepared reports for the AEC on portions of the Appalachian basin, the Michigan basin, the Salina basin, the Denver basin, and the San Juan basin (Galley, 1968-a).

In spite of these extensive investigations, only one well, the Anaconda Company well near Grants, New Mexico (West, 1972), is known to have been used for liquid radioactive waste injection. However, the listed reports are also of general use for evaluation of sites for wells injecting non-radioactive wastes.

Just as major synclinal basins are geologically favorable sites for wastewater injection, other areas may be generally unfavorable because the sedimentary-rock cover is thin or absent. Extensive areas where relatively impermeable igneous-intrusive and metamorphic rocks are exposed at the surface are shown in Figure 4-2. With the possible exception of small parts, these areas can be eliminated from consideration for waste injection. The exposure of igneous and metamorphic rocks in the Appalachian Mountains, Wichita Mountains, Llano, and Ozark uplifts, the extensive outcrops of the Canadian

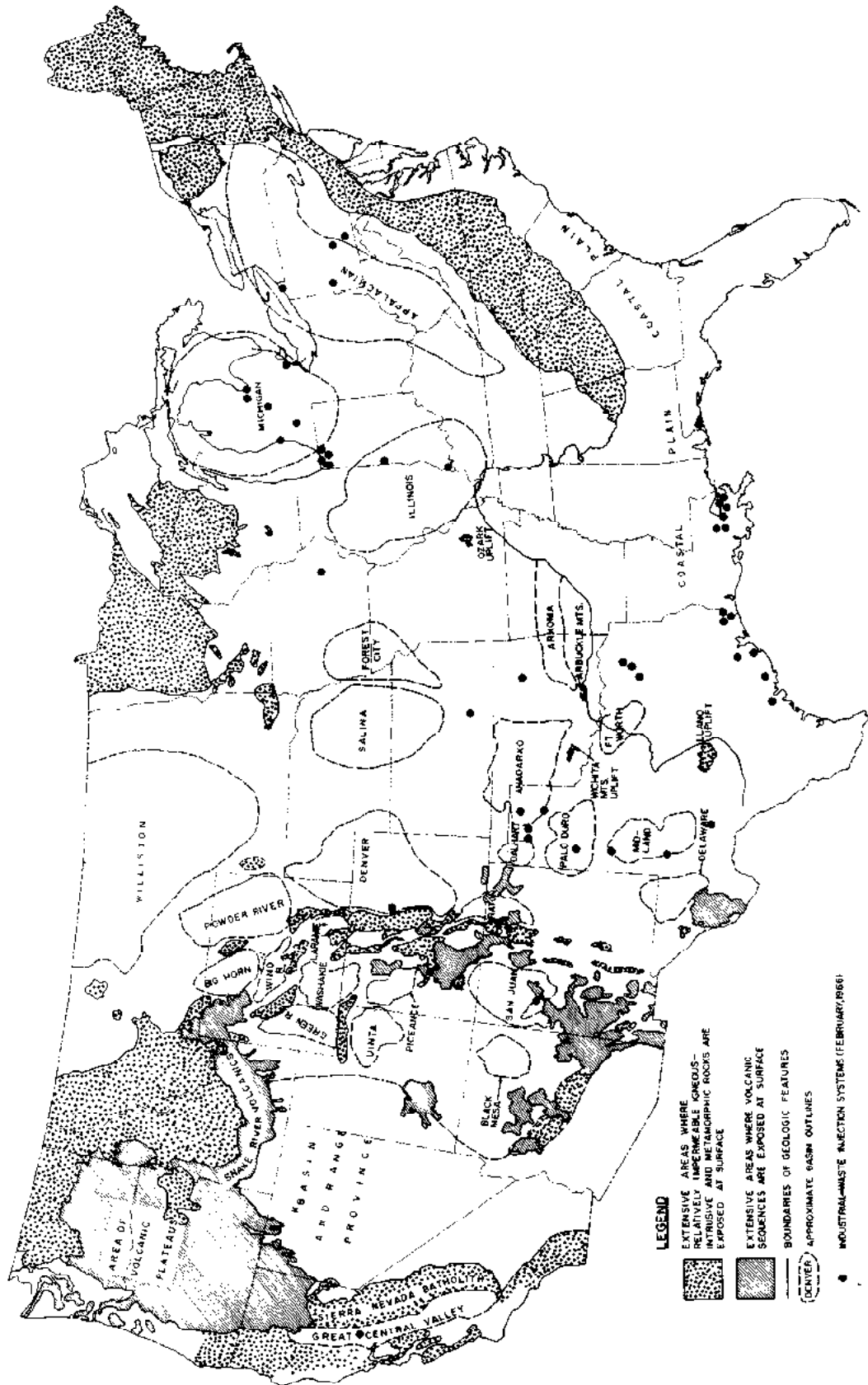

FIGURE 4-2. GEOLOGIC FEATURES SIGNIFICANT IN DEEP WASTE-INJECTION WELL-SITE EVALUATION, AND LOCATIONS OF INDUSTRIAL-WASTE INJECTION SYSTEMS (WARNER, 1968).

Shield, and other such exposures are perhaps not extensive, but they are significant because the sedimentary sequence thins toward them and the salinity of the formation waters decreases toward the outcrops around the exposures.

Regions shown in Figure 4-2 where a thick volcanic sequence lies at the surface generally are not suitable for waste-injection wells. Although volcanic rocks have fissures, fractures, and interbedded gravel that will accept injected fluids, they generally contain fresh water.

The immense and geologically complex Basin and Range Province is a series of narrow basins and intervening, structurally positive ranges. Some of the basins might provide waste-injection sites, but their geology is mostly unknown and the cost of obtaining sufficient information to insure safe construction of injection wells could be high.

The geology of the West Coast is relatively complex. Small Tertiary sedimentary basins in southern California yield large quantities of oil and gas, and probably are geologically satisfactory sites for waste-injection wells. There are similar basins along the coast of northern California, Oregon, and Washington, but little is known about their geology.

Areas not underlain by major basins or prominent geologic features may be generally satisfactory for waste injection if they are underlain by a sufficient thickness of sedimentary rocks that contain saline water, and if potential injection zones are sealed from fresh-water-bearing strata by impermeable confining beds.

A number of discussions have appeared in recent years, describing the feasibility of industrial wastewater injection in individual states and one region, including those by Bergstrom (1968) on Illinois, Kreidler (1968) on New York, Newton (1970) on Oregon, Rudd (1972) on Pennsylvania, Clifford (1972) on Ohio, Tucker and Kidd (1973) on Alabama, and the Ohio River Valley Water Sanitation Commission (1973) on the Ohio River Valley region. The study of the Ohio River Valley will be briefly reviewed as an example of a regional assessment. Figures 4-3 through 4-9 are from the ORSANCO (1973) study.

#### Example of a Regional Evaluation

##### Stratigraphy --

The thickness of sedimentary rocks throughout the area can be estimated by examination of Figure 4-3, which is a structure contour map on the top of the Precambrian basement surface. The thickness of sedimentary rock at any point is obtained by subtracting the elevation of the Precambrian surface from the elevation of the ground surface. Since all of the Precambrian surface elevations in the map are below sea level, and elevations are negative, they are actually added. It is clear that there is more than 3,000 feet of sedimentary rocks except in Virginia, where Precambrian rocks are exposed at the surface. In the basinal areas, as much as 70,000 feet of rocks are present. Rocks of interest as possible injection intervals occur from the base

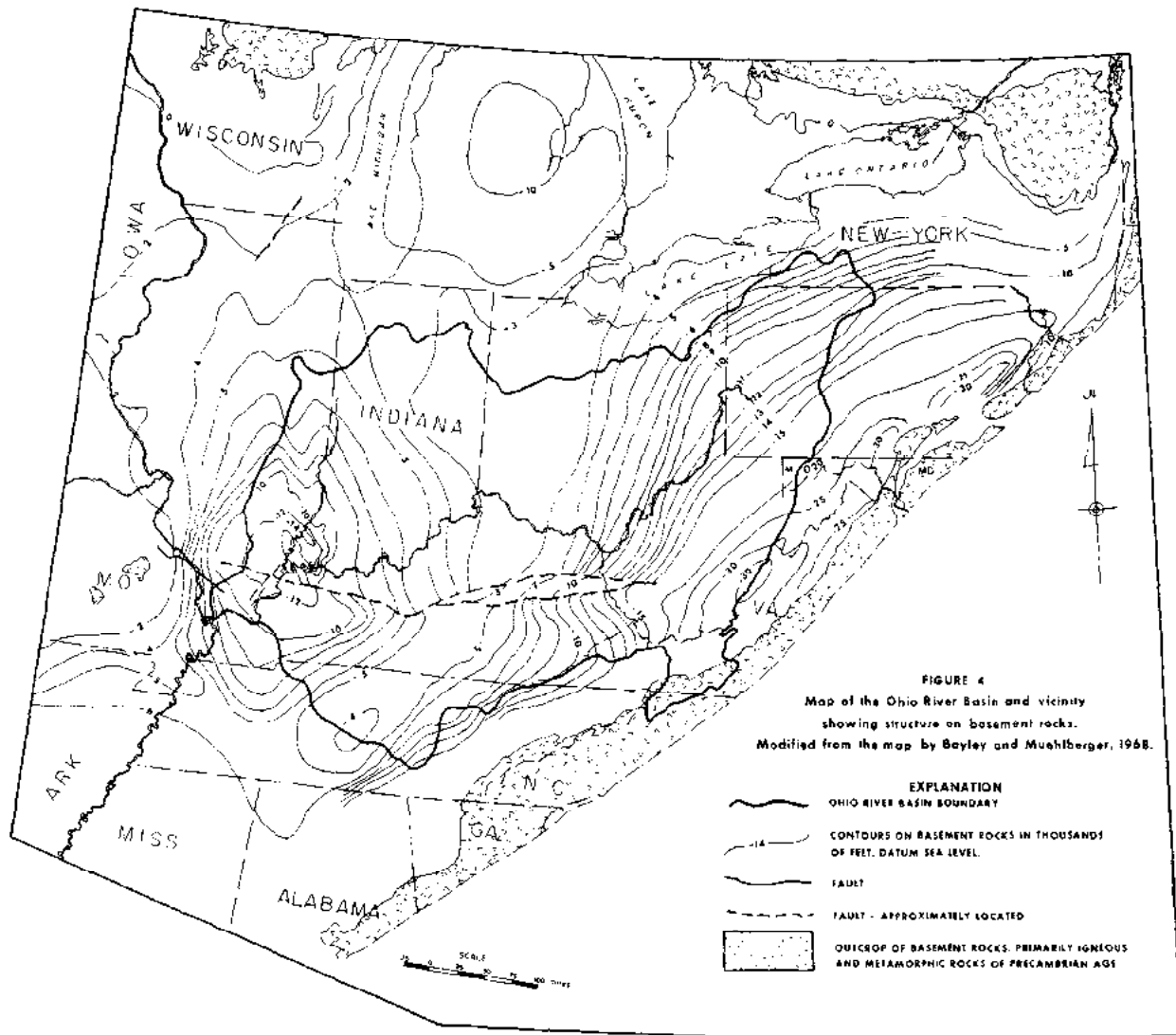

FIGURE 4-3. (OHIO RIVER VALLEY WATER SANITATION COMMISSION, 1973).

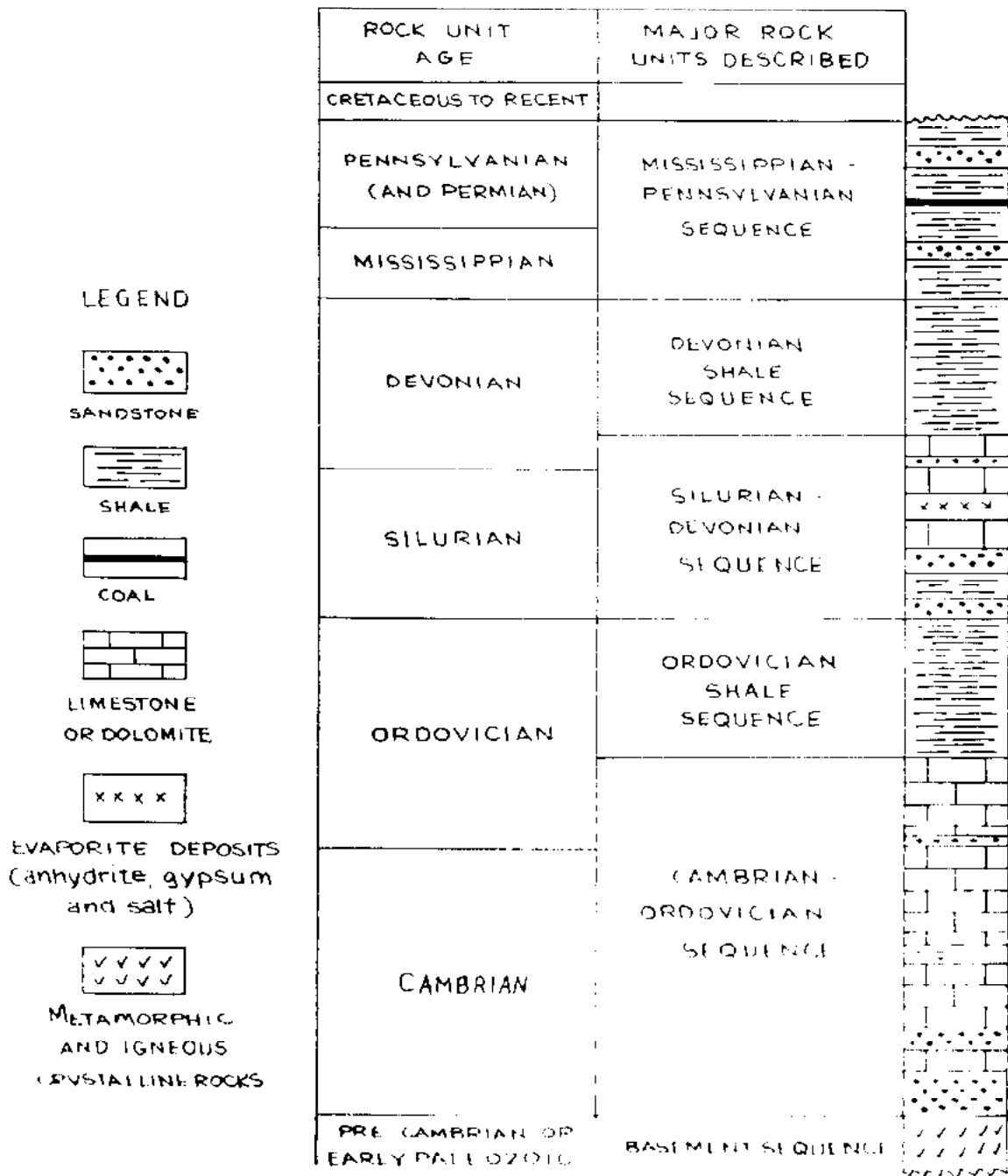

FIGURE 1-4. DIAGRAMMATIC COMPOSITE GEOLOGICAL COLUMN OF ROCK SEQUENCES IN THE OHIO RIVER BASIN (OHIO RIVER VALLEY WATER SANITATION COMMISSION, 1978).

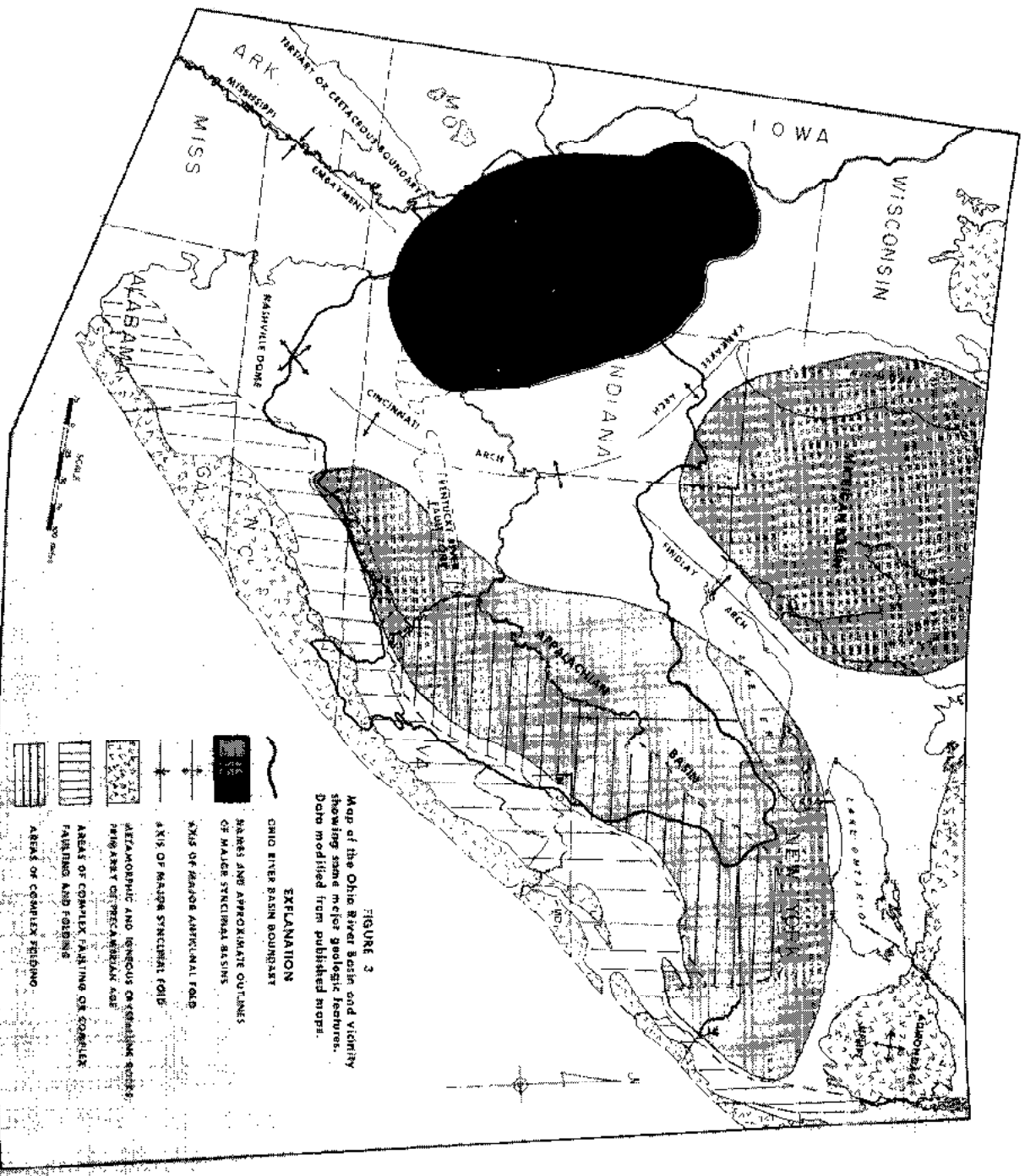

FIGURE 4-5. (OHIO RIVER VALLEY WATER SANITATION COMMISSION, 1973).



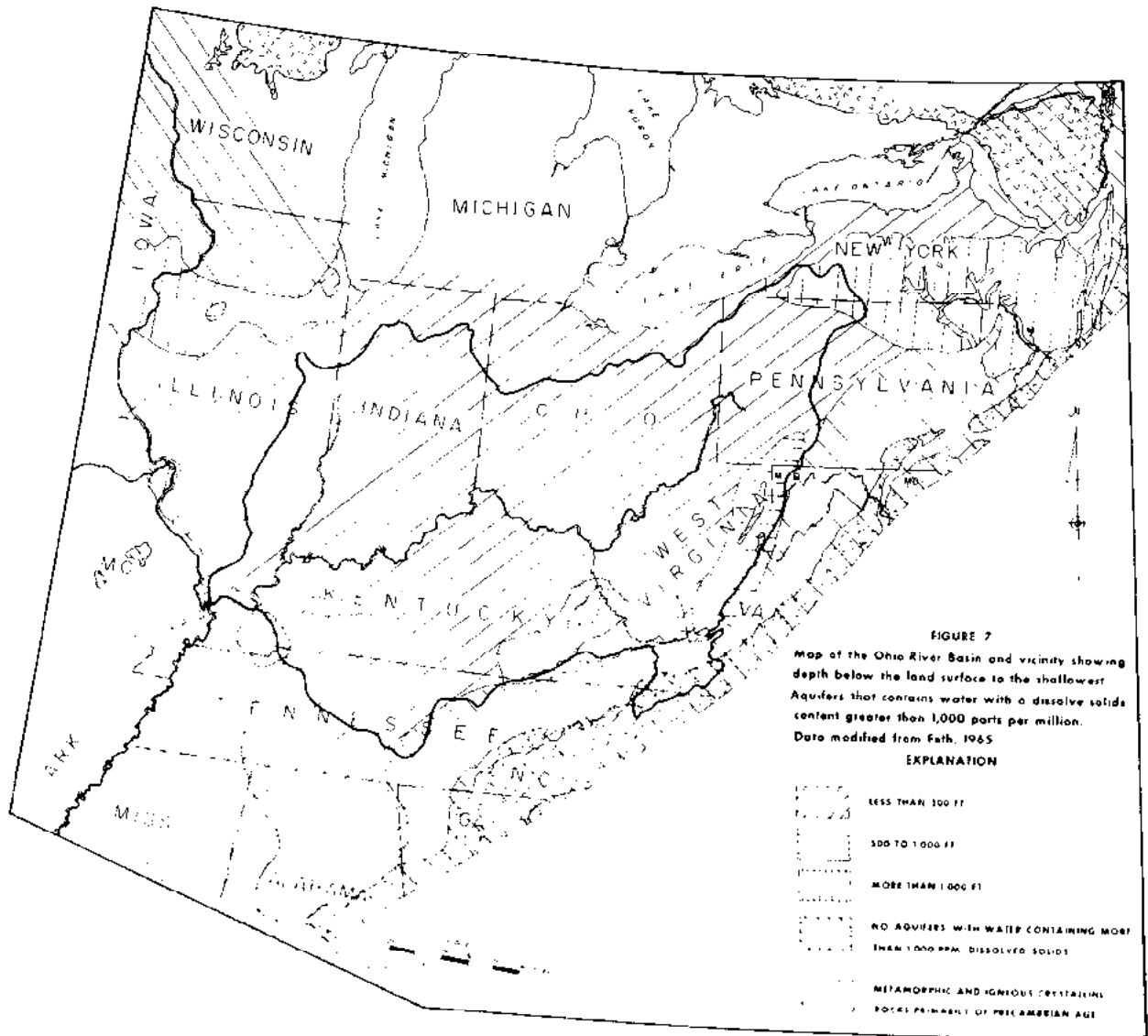

FIGURE 4-6. (OHIO RIVER VALLEY WATER SANITATION COMMISSION, 1973).

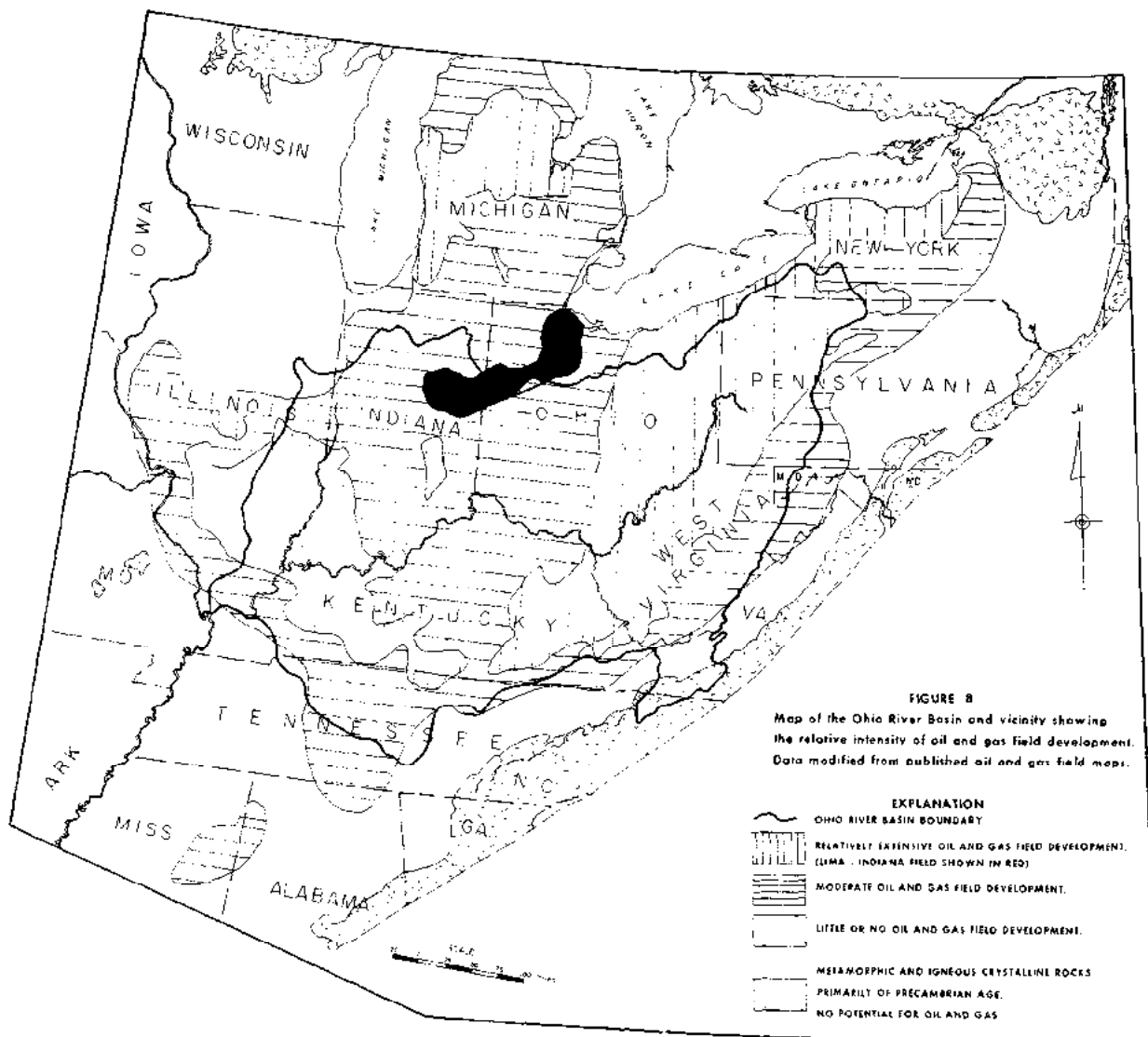

FIGURE 4-7. (OHIO RIVER VALLEY WATER SANITATION COMMISSION, 1973).

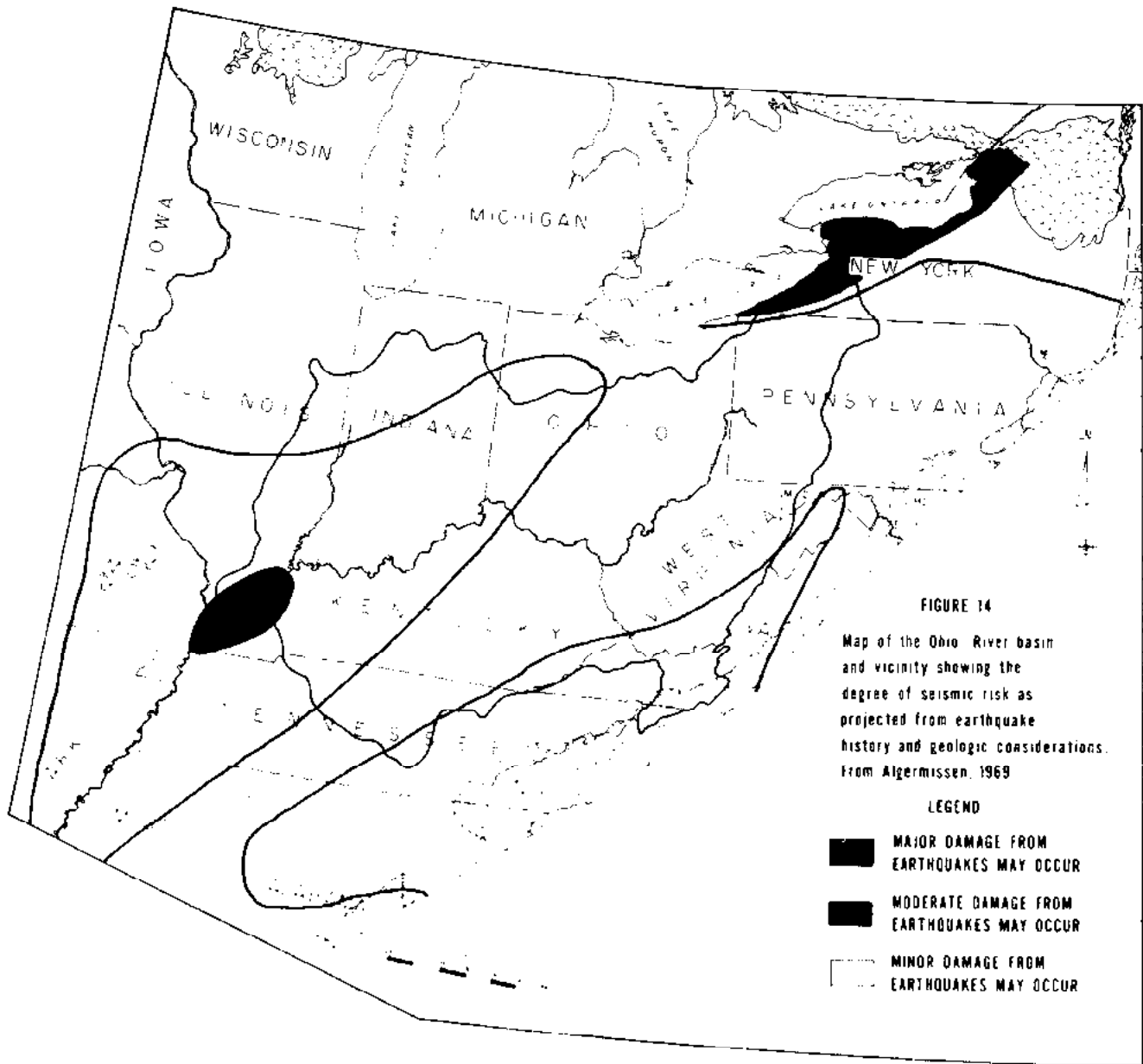

FIGURE 14

Map of the Ohio River basin and vicinity showing the degree of seismic risk as projected from earthquake history and geologic considerations. From Algermissen, 1969

LEGEND

- MAJOR DAMAGE FROM EARTHQUAKES MAY OCCUR
- ▨ MODERATE DAMAGE FROM EARTHQUAKES MAY OCCUR
- ▭ MINOR DAMAGE FROM EARTHQUAKES MAY OCCUR

FIGURE 4-10. MAP OF THE OHIO RIVER BASIN AND VICINITY SHOWING THE DEGREE OF SEISMIC RISK AS PROJECTED FROM EARTHQUAKE HISTORY AND GEOLOGIC CONSIDERATIONS. FROM ALGERMISSEN, 1969.

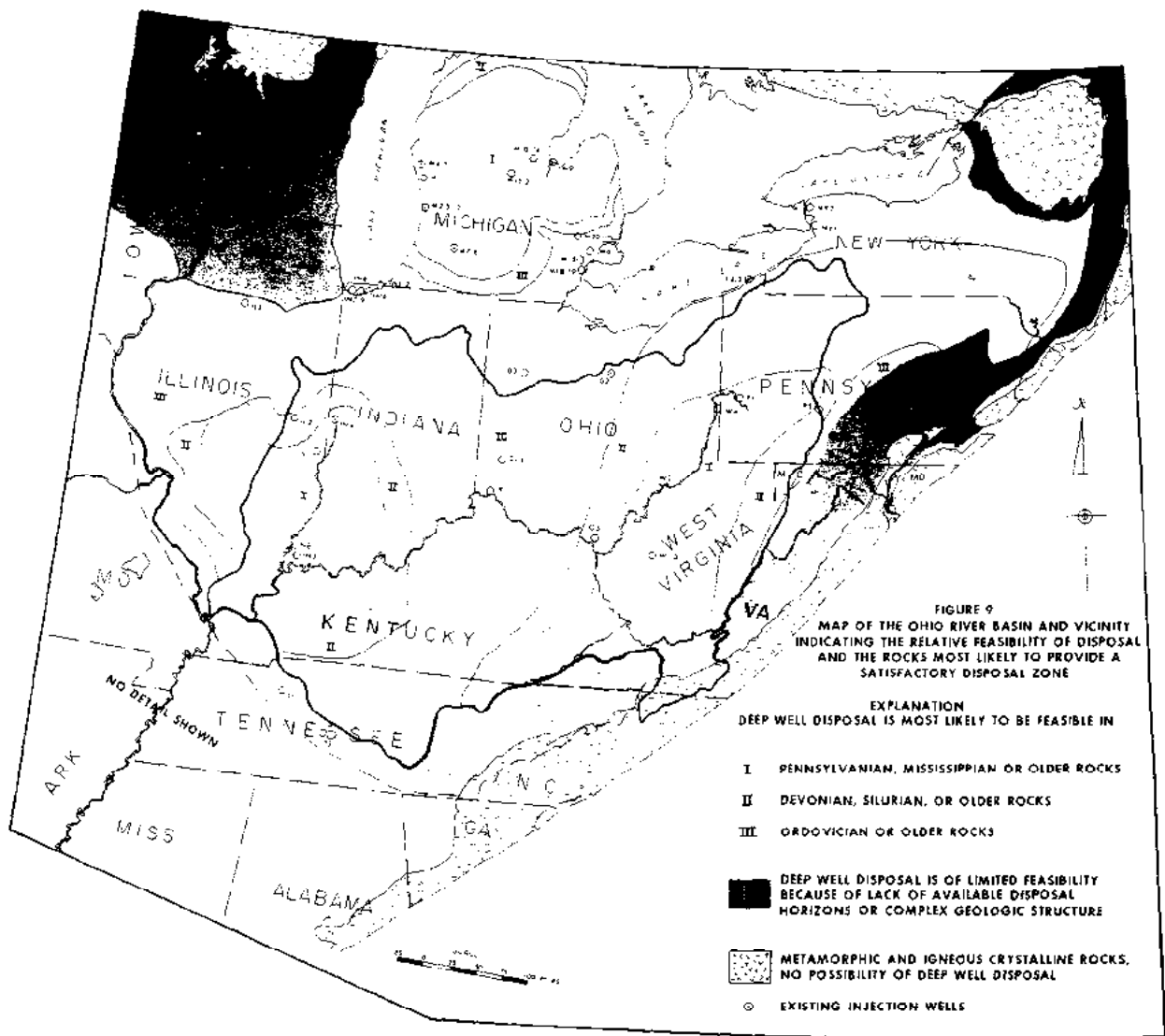

FIGURE 4-9. MAP OF THE OHIO RIVER BASIN AND VICINITY INDICATING THE RELATIVE FEASIBILITY OF DISPOSAL AND THE ROCKS MOST LIKELY TO PROVIDE A SATISFACTORY DISPOSAL ZONE.

to near the top of the sedimentary sequence and are from Cambrian to Pennsylvanian in age as shown in Figure 4-4.

#### Structural Geology --

Major structural geologic features of the Ohio Valley and surrounding areas are shown in Figure 4-5. Major synclinal basins or downwarps of the crust are the Appalachian basin and the Illinois basin. Small portions of the Michigan basin and the Mississippi embayment are also within the Ohio Valley. The Cincinnati arch and its continuations, the Kankakee and Findlay arches to the north and the Nashville dome to the south are major uplifts separating the basins. The outcrop of crystalline rocks that forms the core of the Appalachian Mountain ranges (Blue Ridge province) represents a major anticlinal fold that bounds the Appalachian basin on the southeast. Each of the major folds has many smaller ones superimposed upon it. The southeastern portion of the Appalachian basin is, in particular, complexly deformed by many smaller folds as indicated in Figure 4-5. A zone of very intense and complex folding, faulting and fracturing ranging from a few miles up to about 80 miles in width borders the northeast-southwest trending crystalline core of the Appalachian Mountains from the Alabama-Georgia border north into Canada. Other areas of relatively intense rock deformation are the faulted and fractured Rough Creek, Kentucky River, and associated fault zones.

#### Ground Water and Other Resources --

The principal chemical measurement used to distinguish between reservoirs suitable for wastewater injection and those containing waters that must be protected is total dissolved solids content. So far, there is no complete agreement on which ground waters should be protected, but perhaps this is best because exceptional cases occur and a rigid restriction makes it difficult to accommodate them. The most restrictive policy known is used in Illinois and Texas, where ground water containing less than 10,000 mg/liter is protected. On the other hand, injection is presently being allowed into an aquifer with water containing less than 1,000 mg/liter in at least one instance and Florida uses a limiting value of 1,500 mg/liter for aquifers to be protected.

In Figure 4-6 it shows the approximate depth to aquifers containing greater than 1,000 ppm of dissolved solids in the Ohio Valley and adjacent areas. This map was used because it is the only one available showing the dissolved solids content of ground waters in the Ohio Valley region. It gives a very broad indication of the depth range to which surface casing must extend in order to close off aquifers containing potable water. It also shows that there are no saline-water-bearing aquifers to be used for disposal in portions of the eastern Ohio Valley. If waters containing more than 1,000 ppm of dissolved solids are considered fresh, which will probably be the case, then larger areas of the Ohio Valley would be unsuited for underground disposal and the depth to the fresh water-saline water interface would be extended.

Of the mineral resources, oil and natural gas frequently require careful control because of their abundance and because they are found in strata containing other

are often physically well suited for waste injection. In Figure 4-7 the relative extent of oil and gas field development in the Ohio Valley area is shown. Extensive development of oil and gas resources does not necessarily preclude injection disposal. However, the potential for such disposal will, within certain areas, be greatly limited because of oil and gas development. For example, in the Lima-Indiana oil field area shown in Figure 4-7, nearly 75,000 wells were drilled during the late 1800's and early 1900's. These oil wells are now abandoned and many of their locations are unknown.

Because of the inadequate plugging practices used at the time when the Lima-Indiana field was abandoned, it is not now possible to contemplate injection into the Trenton Limestone or any of the horizons above the Trenton in that area. Injection into the deeper Mt. Simon Formation, which lies well below the Trenton, is still possible as is illustrated by the Sohio Petroleum Company injection well at Lima, Ohio. It is not practical to list all of the situations similar to this that exist in the Ohio Valley. However, matters such as this must be considered individually at the time when underground disposal is actually contemplated at a specific location.

#### Earthquake Occurrence and Triggering --

The past history of earthquake activity in an area must be considered because an earthquake might potentially damage injection well facilities or alter geohydrologic conditions. In addition, because of the possibility that injection may induce earth tremors, the susceptibility of an area to such induced seismic activity should be examined.

Within and near the Ohio Valley Region, two localities stand out as having been affected by significant earthquakes during recorded time. Three of the most intense earthquakes that have been recorded in this country were centered near New Madrid, Missouri, and occurred in December, 1811, and January and February, 1812. All three of these earthquakes were of greater intensity than any that have occurred in California, including the 1906 San Francisco earthquake.

A second area in the Ohio Valley where relatively intense earthquakes have been recorded is in western New York. Here earthquakes with intensities of 8 were recorded in 1929 and 1944. These two earthquakes were centered near Attica and Massena, New York, respectively. Changes in groundwater conditions reportedly occurred in 1929. A less intense 1966 earthquake was also centered near Attica, New York. Recent data depicting the degree of seismic risk throughout the Ohio Valley are shown in Figure 4-8. These data agree with the above discussion and indicate that there is a possibility of major earthquake damage in the extreme southeast and northeast portions of the Ohio Valley and of moderate to minor damage elsewhere in the area. These areas are also ones where the initiation of earthquakes would be most likely. In fact, it has been reported that seismic activity has been stimulated in the Dale, New York, area by injection of brine from solution mining.

Summary --

The geology and groundwater hydrology of the Ohio Valley have been broadly considered in view of the potential for subsurface waste injection in the area. Implications of the previous discussion are partly summarized in Figure 4-9. Here is indicated the relative feasibility of deep-well disposal as constrained by the thickness of sedimentary rocks, geologic structure, and the presence of saline-water-bearing aquifers. Areas underlain only by metamorphic and igneous crystalline rocks provide virtually no potential for subsurface disposal of liquid waste. Areas where subsurface waste injection is indicated as being of limited feasibility are those where:

No aquifers containing more than 1,000 mg/l of dissolved solids are available, as indicated in Figure 4-6;

The saline-water-bearing sedimentary sequence is less than 1,500 feet thick;

Structural geologic conditions are considered sufficiently complex to cause great uncertainty about subsurface hydrology.

Within the areas where the above limitations do not apply, feasibility of waste injection is shown as being most likely in one or more of the stratigraphic sequences indicated in Figure 4-9. In Zone I, disposal feasibility is shown as being most likely in Pennsylvanian, Mississippian, or older rocks. There is at least 1,500 to 2,000 feet of Mississippian-Pennsylvanian sedimentary rock present containing water with 1,000 mg/l or more of dissolved solids in Zone I. In Zone II, there is at least 1,500 to 2,000 feet of Silurian-Devonian rock present containing saline water and in Zone III there is at least 1,500 to 2,000 feet of Ordovician and Cambrian sedimentary rock present containing saline water.

While Figure 4-9 offers broad geographic guidelines, it cannot be used to specify where subsurface injection may or may not be permitted. For example, in constructing the map, aquifers with water containing more than 1,000 mg/l were considered as having waste-disposal potential, whereas, at least in Illinois and New York, the dissolved solids content would have to be greater (10,000 mg/l and 2,000 mg/l, respectively) before an aquifer could be considered for waste injection. Some other limitations of the map are:

It does not consider the presence of unplugged abandoned wells or the locations of mineral resources.

The fact that 1,500 feet or more of saline water-bearing sedimentary rock is present does not assure that a suitable porous and permeable injection horizon or a suitable confining interval will be present.

Areas of relatively high seismic risk are not excluded for use because evaluation of the hazard of earthquake

damage and earthquake mitigation are considered to be related to specific well location and depth.

This illustrates the procedure used in a regional evaluation. It is not considered desirable to try to establish specific numerical criteria that can be used everywhere, because of the obvious difficulty of doing so for even one individual area. Also, it should be realized that only rarely, if ever, will any such regional study allow more than a preliminary evaluation of the suitability of a specific site, unless the site is in a totally unacceptable location, in which case no further evaluation is needed. If a site is located in a generally acceptable area, then a detailed examination of the local geology and subsurface hydrology is required prior to construction of a test well, and a reevaluation made after the well has been constructed and tested.

#### LOCAL SITE EVALUATION

Factors for consideration in local site evaluation are listed in Table 4-1. Figure 4-10 is, similarly to Figure 4-1, a flow diagram that illustrates the local site evaluation procedure. As with Figure 4-1, it should not be considered a rigid format.

Very briefly, a potential disposal site and injection interval should have the following characteristics:

- a. Injection interval sufficiently thick, with adequate porosity and permeability to accept waste at the proposed injection rate without necessitating excessive injection pressures.
- b. Injection interval of large enough areal extent so that injection pressure is minimized and so that injected waste will not reach discharge areas.
- c. Injection interval preferably "homogeneous" (without high-permeability lenses or streaks), to prevent extensive fingering of the waste-vs-formation water contact, which would make adequate modeling and monitoring of waste movement extremely difficult or impossible.
- d. Overlying and underlying strata (confining beds) sufficiently thick and impermeable, to confine waste to the injection interval.
- e. Structural geologic conditions generally simple, that is a site reasonably free of complex faulting and folding.



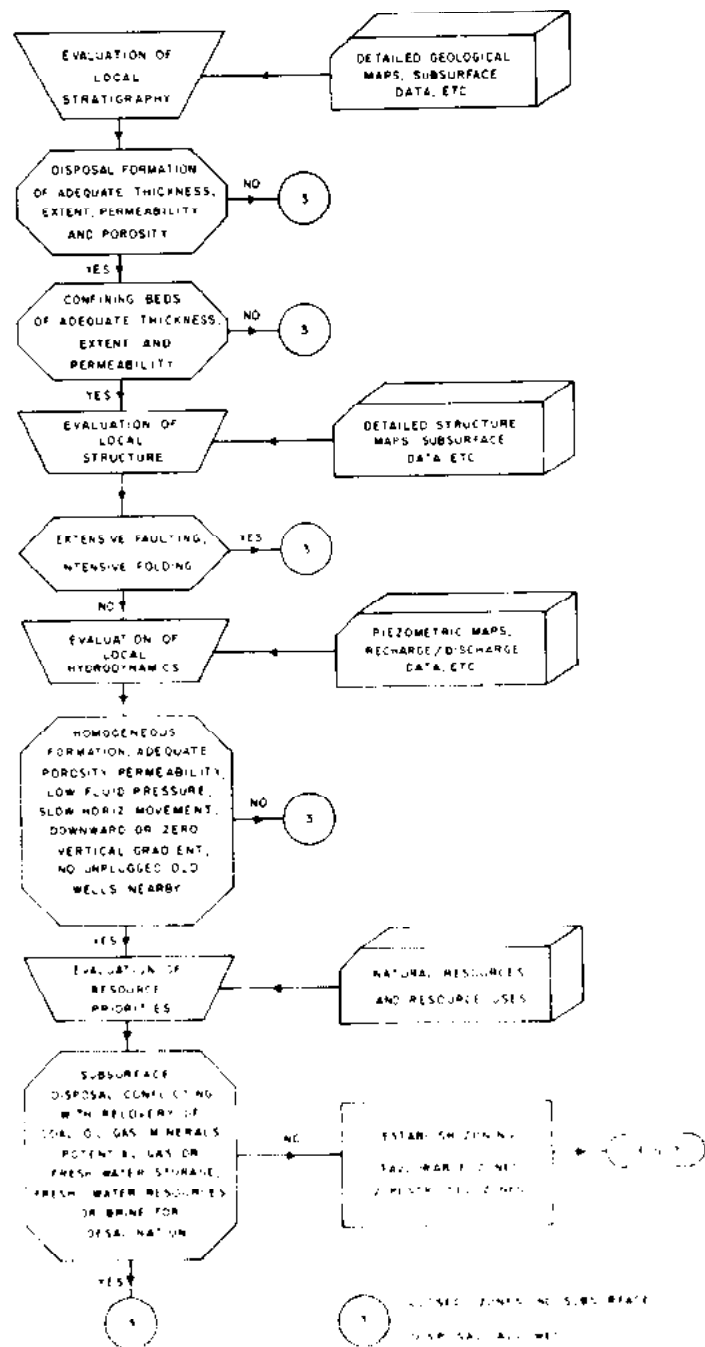

FIGURE 2-11. SELECTION OF FORMATIONS AND AREAS FOR SUBSURFACE DISPOSAL OF INDUSTRIAL WASTE. (VAN DER POORT AND FREEMAN, 1970)

- f. Site is an area of minor to moderate earthquake damage and low seismic activity so that the hazard of earthquake damage or triggering of seismic events is minimized.
- g. Slow lateral movement of fluid in the injection interval, under natural conditions, to prevent rapid movement of waste away from the injection site, possibly to a discharge area.
- h. Formation-fluid pressure normal or low so that excessive fluid pressure is not needed for injection.
- i. Formation temperature normal or low so that the rates of undesirable reactions are minimized, including corrosion.
- j. Wastewater compatible with formation fluids and minerals or can be made compatible by treatment, emplacement of a buffer zone, or other means.
- k. Formation water in the disposal formation of no apparent economic value. i. e. not potable, unfit for industrial or agricultural use, and not containing minerals in economically recoverable quantities.
- l. Injection interval adequately separated from potable water zones, both horizontally and vertically.
- m. Waste injection not to endanger present or future use of mineral resources (coal, oil, gas, brine, others).
- n. Waste injection not to affect existing or planned gas-storage or freshwater-storage projects.
- o. No unplugged or improperly abandoned wells penetrating the disposal formation in the vicinity of the disposal site, which could lead to contamination of other resources.

As can be seen from Figure 4-10 and the above list, the same general geologic and engineering properties that are examined at the regional level are also examined at the local level, but in more detail. As has been shown, in a regional examination, an objective is to identify an adequate thickness of rocks within which to find an injection interval and confining strata. At the local level, the objective is to identify specific potential injection intervals and confining strata and to predict their performance under

projected operating conditions. This same rationale applies to other criteria, such as structural geology, hydrodynamics, subsurface resources, etc.

The procedure for local evaluation of an injection well site should first provide for documentation of the results of analysis of items a-o above prior to drilling of a well, then if the site is judged suitable for construction and testing of a well, each item should be reanalyzed as information is obtained during drilling and testing. The final decision as to whether or not wastewater injection is feasible is based on the subsurface data that have been acquired during drilling and testing and which have then been used to project the response of the subsurface geologic and hydrologic system to sustained injection.

No specific numerical criteria are suggested in this chapter to be employed in site evaluation, but numerous quantitative examples are given in Chapter 3, as are the means of acquiring data for site evaluation prior to and during well construction.

#### Example of Local Site Evaluation

To illustrate local site evaluation procedures, the characteristics listed above will be applied to the siting of a well for injection of low level radioactive wastes at the Midwest Fuel Recovery Plant (MFRP) of the General Electric Company near Morris, Illinois. The plant is not operative and never has been; but, if it ever should operate, subsurface injection would be one alternative for handling of the tritium-bearing wastes that result from reprocessing of nuclear fuel (Belter, 1972). This particular example was chosen principally because of the ready availability of the needed information and because the site lies within the region evaluated in the first part of this chapter. The characteristics a-o, listed above, will be addressed in sequence.

In addition to the reference sources that are cited, information concerning the superficial geology and shallow subsurface geology was obtained from the "Safety Analysis Report, Midwest Fuel Recovery Plant, Morris, Illinois," NEDO-10178, December, 1970.

#### Geographic Description of the Site --

The plant is located in Section 35 of T.34N., R.8E., and Section 2 of T.33N., R.8E. It is about one mile southwest of the confluence of the Kankakee, Des Plaines, and Illinois Rivers and is near the eastern border of Grundy County. It is immediately adjacent to the Dresden Power Station, a nuclear power reactor operated by Commonwealth Edison Co. The ground elevation at the site is approximately 500 ft. and the topography is relatively level. The area is predominantly agricultural.

#### Stratigraphy and Reservoir Properties --

Surface and shallow subsurface investigations at the site have shown that a layer of soil ranging from 4 to 32 inches thick is present. The soil consists of a thin layer of brown loam in the center, flanked on each

of the Maquoketa Group of Ordovician age. Beneath the Maquoketa, the stratigraphic sequence is as shown in Figure 2-1. The estimated thickness of each of the subsurface units is shown below:

STRATIGRAPHIC COLUMN  
MIDWEST FUEL RECOVERY PLANT  
GRUNDY COUNTY, ILLINOIS

<u>SYSTEM</u>	<u>ROCK UNIT</u>	<u>PREDOMINANT ROCK TYPE</u>	<u>ESTIMATED THICKNESS (FEET)</u>
Pennsylvanian	Pottsville (?)	Sandstone	Variable, 80 feet total at one drill site.
Ordovician	Maquoketa	Limestone & Shale	
	Galena	Dolomite	230
	Platteville	Dolomite and Limestone	115
	Glenwood	Sandstone	5 - 30
	St. Peter	Sandstone	165
	Shakopee	Dolomite	70 - 90
	New Richmond	Sandstone and Dolomite	45 - 55
	Oneota	Dolomite	210
Cambrian	Trempeleau	Dolomite	200
	Franconia	Sandstone	130
	Ironton	Sandstone	120
	Galesville	Sandstone	55+
	Eau Claire Confining Unit	Shale	400+
	Basal Sandstone (Mt. Simon Aquifer)	Sandstone	2,500+

As discussed in Chapter 2, the most suitable injection interval in northeastern Illinois is the basal sandstone or Mt. Simon aquifer. Figure 2-3 shows that the basal sandstone should have a thickness of just over 2,500 feet at the site. Figure 2-3 also shows that the basal sandstone is widely

distributed and that it maintains a thickness of over 500 feet throughout most of Illinois and Indiana.

The basal sandstone consists principally of fine-to coarse-grained sandstone. It is commonly poorly sorted and contains conglomeritic zones. Cross-bedding is often visible in cores. It ranges in color from clear in quartzose portions to pink in the arkosic intervals. It may be only slightly cemented and friable, or silica cemented and very hard. Although the formation is primarily sandstone, shale beds are often present, particularly near the top or base. These beds are from a few inches to more than 50 feet thick. The basal sandstone rests unconformably on Precambrian age igneous or metamorphic rocks. In northeastern Illinois, the basal sandstone is overlain directly by the Eau Claire Formation, which is dominantly composed of shale.

The Illinois Water Survey (1973) examined the reservoir properties of the basal sandstone with reference to disposal of brine from desalination plants. Locations from which drill cores were available for analysis are shown in Figure 4-11. Average porosity of the cores was found to be 11 to 13 percent. This agrees well with Figure 2-11, which shows that the average porosity of the basal sandstone at the site should be about 13 percent. The Illinois Water Survey (1973) found that the geometric mean value of core permeabilities from northeastern Illinois locations ranged from about 4 to over 40 millidarcys (Figure 4-12). Field tests from the same area yielded a range of 12.3 to 1040 millidarcys. Because of geologic and engineering considerations, the Illinois Water Survey (1973) concluded that it is reasonable to place more weight on the field tests than on the core analyses. One procedure for evaluating the reservoir response to injection is to assume that the permeability might be any value within the range obtained from the field tests. This procedure will yield a range of pressure buildup estimates. If the site would be acceptable under even the most pessimistic assumption, then construction of a well would appear to be a good risk. If it would not be suitable even under an optimistic assumption, then the site would appear to be a poor risk. The same reasoning can be applied to selection of a compressibility or storage coefficient. No values of compressibility are available for the entire thickness of the basal sandstone, so a value must be estimated. If the compressibility of water alone is considered,  $c = 3 \times 10^{-6} \text{ psi}^{-1}$ . A more reasonable value that would account for the compressibility of the aquifer skeleton also would be  $7.5 \times 10^{-6} \text{ psi}^{-1}$ .

Because the basal sandstone is underlain by Precambrian age crystalline rock, downward migration of injected wastewater is not possible. Figure 2-3 shows that the basal sandstone is overlain directly by about 400 feet of confining beds at the site. Figure 2-6 indicates that the Eau Claire confining interval is principally a shale or siltstone at that location, which is considered a very effective lithology for confining purposes. Core samples of Eau Claire shale from storage fields in northeastern Illinois typically have permeabilities of less than 1 millidarcy. Wastewater injected under pressure will seep upward through some a rock, but at a rate so low that it is not at all apparent when the confining interval is as thick as it is in this instance.

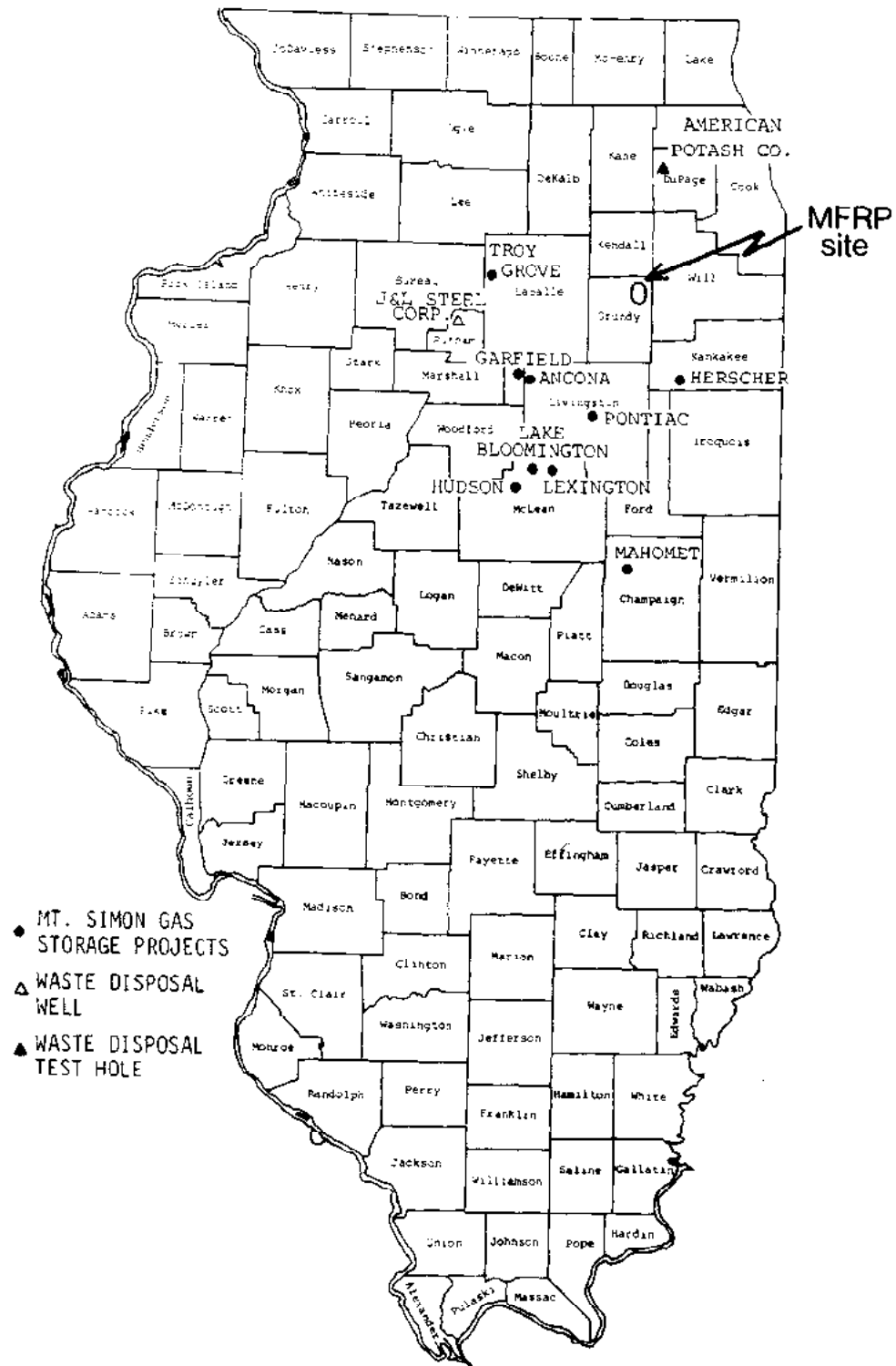

FIGURE 4-11. LOCATIONS OF DRILL CORES FROM MT. SIMON AQUIFER OR BASAL SANDSTONE (ILLINOIS WATER SURVEY, 1973).

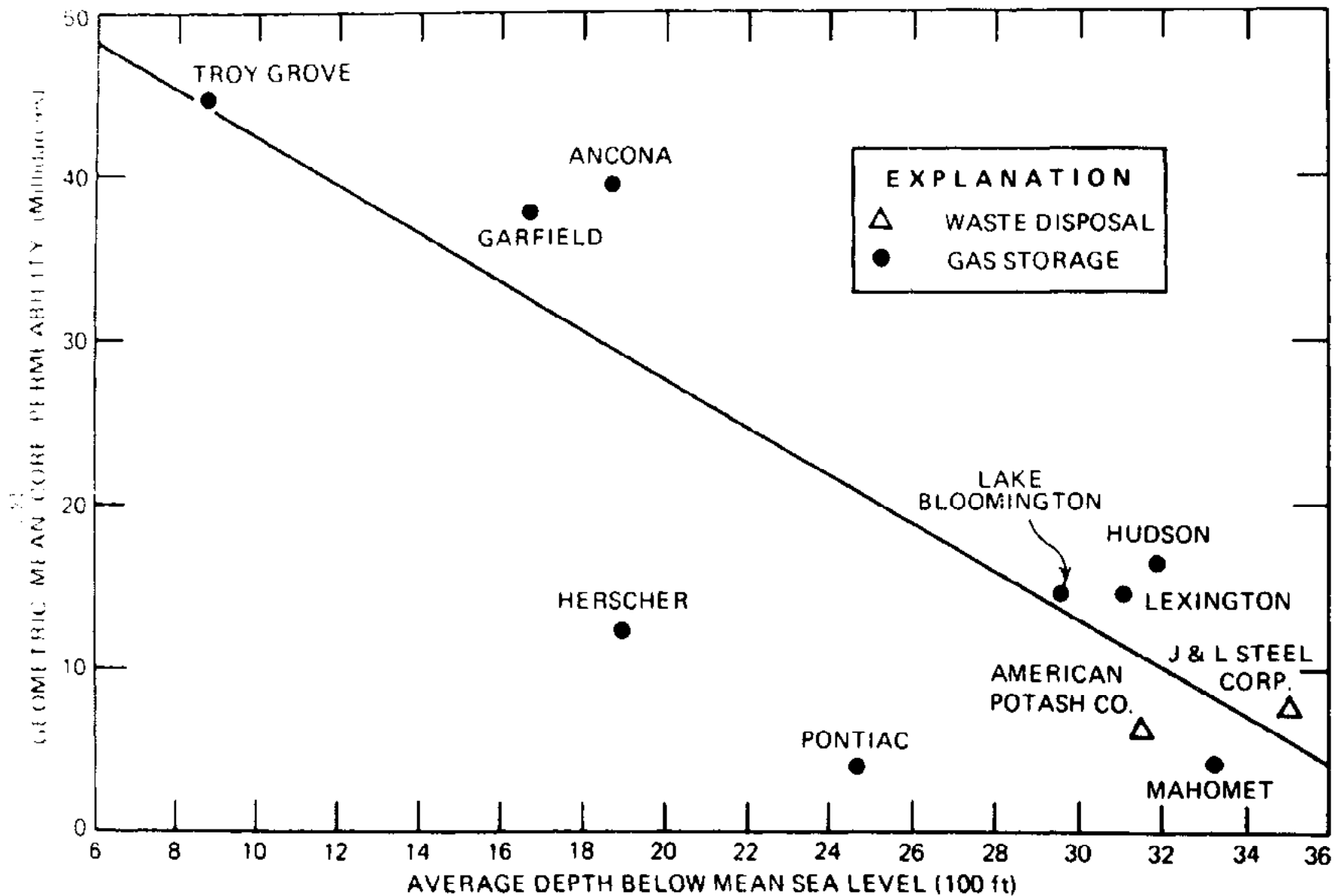

FIGURE 4-12. HORIZONTAL PERMEABILITIES DETERMINED FOR DRILL CORES FROM THE MT. SIMON AQUIFER OR BASAL SANDSTONE (ILLINOIS WATER SURVEY, 1973).

## Structural Geology --

Major structural features in Illinois are shown in Figure 4-13. The plant is located northeast of the Illinois basin and is on the eastern flank of the La Salle anticlinal belt. The regional dip on the top of the basal sandstone is about 25 feet per mile or about one-fourth of a degree southeast, at that location. Dip on the Precambrian basement is about 100 feet per mile or about one degree to the southeast. The only significant structural feature in the immediate vicinity is the Sandwich fault zone. The Sandwich fault zone extends for 150 miles from near Oregon southeastward to a location south of Joliet. It is generally downthrown on the northeastern side, with a maximum displacement of more than 900 feet near its center (McGinnis, et. al., 1976).

The structure is termed the Sandwich fault zone, rather than the Sandwich fault, because it appears to be compound rather than a single fault. As can be seen in Figure 4-13, the plant site is about seven miles south of the Sandwich Fault Zone. According to Buschback (1964), near the Grundy-Will County border, in the vicinity of the plant site, the structure is downthrown on the south side and has a maximum displacement of slightly over 100 feet.

Detailed investigations at the Midwest Fuel Reprocessing Plant site resulted in the location of a northwest trending fault that crosses the southwest corner of the site. The fault is downthrown on the southwest side and has a vertical displacement of about 40 feet. Such a fault would not be of concern unless it were to act as a flow path for liquid escape through the confining beds. This is not likely, but could not be entirely precluded, since leakage of gas from a storage field in northern Illinois has occurred and escape along faults has been advanced as one possible mechanism (Halliden, 1961) for the leakage. As another example, Bond (1972) has suggested the possibility of natural fluid flow from the basal sandstone upward along faults into the overlying Galesville Sandstone in northwestern Indiana.

Initiation and times of movement on the Sandwich fault zone are as follows: Movement did not occur until after the Silurian Period and was perhaps coincidental with movement along the La Salle anticline. Major movements along the La Salle anticline occurred during early Pennsylvanian time, with lesser uplift after the Pennsylvanian period (Payne, 1939; Clegg, 1965; Atherton, 1971). No movement is believed to have occurred along the Sandwich fault zone for millions of years and faults in the zone and those associated with it are classified as inactive.

## Earthquake Occurrence and Triggering --

Figure 4-8 shows the Midwest Fuel Recovery Plant site is an area of minor earthquake damage risk. No special precautions should be needed to protect an injection well from earthquake damage. Because faults in the Sandwich fault zone and vicinity are inactive, the triggering of earthquakes by fluid injection at the site would seem unlikely. However, the presence of the Sandwich fault zone would suggest that this factor should be considered in some detail in reaching a decision as to the suitability of the site for wastewater injection.



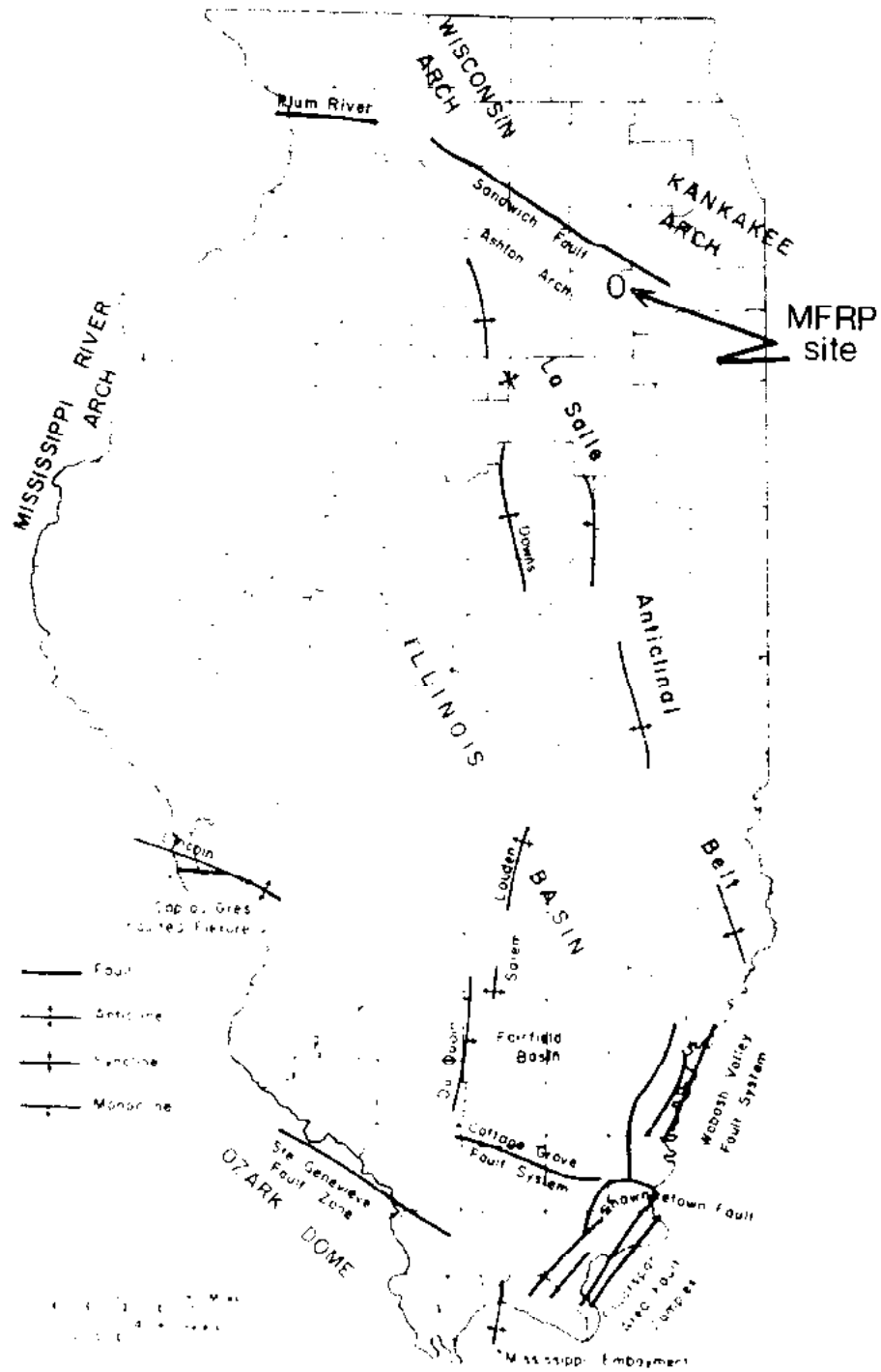

FIGURE 4-13. MAJOR GEOLOGIC STRUCTURES IN ILLINOIS (McGINNIS, ET AL., 1976).

## Hydrodynamics and Reservoir Conditions --

The recharge area for the basal sandstone or Mt. Simon aquifer is southeastern Wisconsin, where precipitation percolates downward through glacial drift and, where present, through a thin cover of overlying bedrock units into the basal sandstone (Illinois Water Survey, 1973). Southward into Illinois, the overlying Eau Claire Formation becomes more shaly and dolomitic (Figure 2-6) and ground water in the basal sandstone occurs under artesian conditions. Movement of ground water in the basal sandstone in northeastern Illinois is believed by Bond (1972) to be southeastward toward Indiana. Flow in northwestern Indiana may then be upward through faults into the Iron-ton-Galesville aquifer, which lies above the Eau Claire confining interval (Bond, 1972). Bond (1972) calculated the rate of movement in the basal sandstone to be a few inches per year. That is consistent with the flow rate in the basal sandstone in Ohio that was calculated in Chapter 3. Hydrodynamic circumstances are, therefore, apparently favorable, since water in the basal sandstone is confined and is moving laterally at the proposed site at a rate so low that geologic time would be required for it to reach a discharge point.

Bond's (1972) data also show that reservoir pressures in the basal sandstone in northern Illinois are in the range that would be anticipated and that no abnormal pressure conditions appear to exist other than minor effects caused by local withdrawal of water or injection of gas through wells for storage purposes. At the site, the dissolved solids content of water in the upper part of the basal sandstone is probably less than 10,000 mg/l whereas the TDS content of water in the lower part would be expected to be much greater (Illinois Water Survey, 1973; Ohio River Valley Water Sanitation Commission, 1976). Therefore, no single hydrostatic pressure gradient is applicable from top to bottom of the basal sandstone. The gradient as measured to the top of the basal sandstone at the site of interest is probably only slightly greater than that of fresh water, which is 0.433 psi/ft whereas at the bottom of the gradient is probably 0.44 to 0.45 psi/ft.

Geothermal gradients are also in the normal range. The geothermal gradient map for Illinois (U. S. Geological Survey-American Association of Petroleum Geologists, 1976) shows a gradient of 1.4° to 1.6°F. per 100 feet of depth for northeastern Illinois. The Illinois Water Survey (1973) reports that the temperature of the upper portion of the Mt. Simon at a gas storage project in La Salle County ranged from 75° to 81°F. Using a geothermal gradient of 1.5° per 100 feet of depth, an average ambient temperature of 55°F., and a depth of 1,850 feet to the top of the basal sandstone, the temperature at the top of the basal sandstone would be estimated to be:

$$55^{\circ}\text{F.} + 1.5(18.5) = 83^{\circ}\text{F.}$$

The temperature at the bottom of the basal sandstone, at a depth of about 4,350 feet would be estimated to be:

$$55^{\circ}\text{F.} + 1.5(43.5) = 120^{\circ}\text{F.}$$

## Compatibility of Wastewater with Formation Water and Minerals --

Trevorrow et. al. (1975) discussed in some detail the probable nature of the low-level wastewater that will result from the commercial reprocessing of spent fuels from light water nuclear reactors. The conclusion reached is that the normal low-level waste will probably be virtually pure water with the exception of nitric acid, which would be present at an estimated concen-

tration of 600 mg/l. Tritium is the contaminant of concern and does not change the density or viscosity of water significantly.

Because of the absence of dissolved ions, reaction with formation water would not be a problem. Since the wastewater will be acidic (pH = 2), unless it is neutralized, reaction with carbonate minerals in the injection interval will occur. The injection interval is a sandstone; therefore reaction would be limited to the carbonate fraction in the sandstone, which is a small amount in the Mt. Simon aquifer in northeastern Illinois. Probably the only reaction that might be significant would be between the wastewater and clay minerals in the sandstone. This possibility would have to be examined by testing of cores from the basal sandstone.

#### Subsurface Resources --

Ground Water--A generalized description of aquifers in northeastern Illinois is given in Table 4-2. Glacial drift and Silurian rocks are not present at the Midwest Fuel Reprocessing Plant site. Ground water was encountered during shallow subsurface studies at four to five feet below the ground surface in weathered and fractured bedrock of the Maquoketa Group. The piezometric level in the shallowest confined aquifer, the Galena-Platteville Dolomite, was estimated to be about 84 feet below the ground surface in one test hole. Aquifers down to and including the Ironton and Galesville sandstones probably contain usable water at the plant site. According to Bergstrom (1968, Fig. 3) water in the Ironton-Galesville Sandstone should contain water with a content of less than 1,500 mg/l total dissolved solids. The upper portion of the basal sandstone (Mt. Simon aquifer) should contain more than 1,500 but less than 10,000 mg/l total dissolved solids. (Bergstrom, 1968; Ohio River Valley Water Sanitation Commission, 1976). The salinity of water in the basal sandstone should increase with depth and should be much greater than 10,000 mg/l total dissolved solids. The lower basal sandstone in the Jones and Laughlin Steel Company well in Putnam County, west of the Midwest Fuel Reprocessing Plant site, contained water with about 62,000 mg/l total dissolved solids.

Water with less than 10,000 mg/l total dissolved solids is protected under present regulatory policy in Illinois. Therefore, it is possible that wastewater injection would be precluded at the Midwest Fuel Reprocessing Plant site. The actual chemistry of water in the basal sandstone would have to be confirmed by drilling and a regulatory decision then made whether or not to allow wastewater injection. Because the Eau Claire confining interval is about 400 feet thick and is composed principally of siltstone and shale, upward vertical leakage of injected waste would not be expected to endanger shallower aquifers, unless local faulting provided a means of vertical movement of water from the basal sandstone. The only nearby well penetrating the basal sandstone is located in Sec. 21, T.34N., R.6E., two to three miles north of the plant site. The well was drilled as a gas storage exploratory test and has been plugged. The basal sandstone was encountered at a depth of 1,267 feet in this well, which was drilled only 24 feet into the basal sandstone (Ohio River Valley Water Sanitation Commission, 1976).

TABLE 4-2. GENERALIZED DESCRIPTION OF  
AQUIFERS IN NORTHEASTERN ILLINOIS

GEOLOGIC UNITS	THICKNESS (ft)	WATER-YIELDING PROPERTIES
Glacial drift	0-400+	Yields of wells variable, some well yields greater than 1000 gpm
Silurian dolomite	0-400+	Yields of wells variable, some well yields greater than 1000 gpm
Maquoketa shale	0-250	Generally not water-yielding, acts as barrier between shallow and deep aquifers
Galena-Platteville dolomite*	150-350	Water-yielding where not capped by shales
Glenwood-St. Peter sandstone*	75-650	Estimated transmissivity 15 percent that of Cambrian-Ordovician aquifer
Prairie Du Chien, Trempealeau dolomite, and Franconia Formations*	45-790	Estimated transmissivity 35 percent that of Cambrian-Ordovician aquifer
Ironton-Galesville sandstone*	103-275	Estimated transmissivity 50 percent that of Cambrian-Ordovician aquifer
Eau Claire shale	235-450	Generally not water-yielding, acts as barrier between Ironton-Galesville and Mt. Simon
Eau Claire and Mt. Simon sandstones	2000±	Moderate amounts of water, permeability between that of Glenwood-St. Peter and Ironton-Galesville, water quality problem with depth

\*Collectively referred to as Cambrian-Ordovician aquifer

Oil and Gas--No significant petroleum resources are known to exist in northeastern Illinois.

Coal--Coal is present in Pennsylvanian age strata in the vicinity of the Midwest Fuel Reprocessing Plant, but not on the plant site itself. Coal beds are very near the surface in this area and would not be affected by wastewater injection into the basal sandstone.

Gas Storage--Natural gas is stored in anticlinal structures at several locations in northern Illinois (Buschbach and Bond, 1973). Since no potential storage structure has been defined at the plant site or in the immediate vicinity, wastewater injection would not be expected to conflict with gas storage.

Summary --

After cursory examination of the characteristics listed as important in a local site evaluation, it appears that the Midwest Fuel Recovery Plant site favorably meets most criteria, but may not meet some. First, the basal sandstone, which is the likely injection interval, probably contains water with less than 10,000 mg/l dissolved solids in the upper part. Under present Illinois policy and practice it would not be permissible to inject into such a reservoir. Second, the plant site is within about seven miles of the Sandwich fault zone and one fault has been identified at the plant site. The local faulting could provide a pathway for vertical escape of fluid from the injection interval, and the possibility that increased subsurface fluid pressure could activate movement on faults in the area cannot be entirely precluded. If serious interest were to exist in constructing and operating an injection well at the site, these problem areas would need to receive critical examination.

## REFERENCES

### CHAPTER 4

- Atherton, Elwood. "Tectonic Development of the Eastern Interior Region of the United States." Bond, D. C., Chairman, Background Materials for Symposium on Future Petroleum Potential of NPS Region 9 (Illinois Basin, Cincinnati Arch, and northern part of Mississippi Embayment): Illinois State Geological Survey Illinois Petroleum 96. 1971 pp. 29-43.
- Beikman, H. M. Geology of the Powder River Basin, Wyoming and Montana, with Reference to Subsurface Disposal of Radioactive Wastes. U. S. Geological Survey Trace Elements Inv. Report 823 (open file). 1962.
- Belter, W. G. "Deep Disposal Systems for Radioactive Wastes." in Underground Waste Management and Environmental Implications. T. D. Cook, ed. Am. Assoc. of Petroleum Geologists Memoir 18, Tulsa, Oklahoma. 1972. pp. 341-354.
- Bergstrom, R. E. Feasibility of Subsurface Disposal of Industrial Wastes in Illinois: Illinois State Geological Survey Circular 426. 1968.
- Bond, D. C. Hydrodynamics in Deep Aquifers in the Illinois Basin: Illinois State Geological Survey Circular 470. 1972.
- Buschbach, T. C. Cambrian and Ordovician Strata of Northeastern Illinois. Illinois Geological Survey Report of Investigations 218. 1964. 90 pp.
- Buschbach, T. C., and Bond, D. C. Underground Storage of Natural Gas in Illinois. Illinois Geological Survey Petroleum 101. 1974. 71 pp.
- Clegg, K. E. "The La Salle Anticlinal Belt and Adjacent Structures in East-Central Illinois." Transactions of the Illinois Academy of Science. v. 58, no. 2. p. 82-94; Illinois State Geological Survey Reprint 1965-H. 1965. 13 pp.
- Clifford, M. J. Feasibility of Deep-Well Injection of Industrial Wastes in Ohio. Ohio State University. Unpublished M. S. thesis. 1972.
- Colton, G. W. Geologic Summary of the Appalachian Basin, with Reference to the Subsurface Disposal of Radioactive Waste Solutions. U. S. Dept. of the Interior Geological Survey. TEI-791. June, 1961.

- Galley, J. E. "Economic and Industrial Potential of Geologic Basins and Reservoir Strata." in Subsurface Disposal in Geologic Basins - A Study of Reservoir Strata. J. E. Galley, ed. Amer. Assoc. of Petroleum Geologists, Inc., Tulsa, Oklahoma. 1968. pp. 1-10.
- Galley, J. E., ed. Subsurface Disposal in Geologic Basins - A Study of Reservoir Strata. A. A. P. G. Memoir 10. Amer. Assoc. Petroleum Geologists, Inc., Tulsa, Oklahoma. 1968a.
- Halden, O. S. "Underground Natural Gas Storage (Herscher Dome)." in Ground Water Contamination. U. S. Dept. of Health, Education and Welfare, Technical Report W61-5. Cincinnati, Ohio. 1961. pp. 110-115.
- Hidalgo, R. V. and Woodfork, L. D. "EDP as an Aid for Decision Making in Subsurface Injection of Liquid Wastes." in Underground Waste Management and Artificial Recharge. J. Braunstein, ed. Amer. Assoc. Petroleum Geologists, Inc., Tulsa, Oklahoma. 1973. pp. 133.
- Illinois Water Survey. Feasibility Study on Desalting Brackish Water from the Mt. Simon Aquifer in Northeastern Illinois. Urbana, Illinois. 1973. 120 pp.
- Kreidler, W. L. "Preliminary Study of Underground Disposal of Industrial Liquid Waste in New York State." in Subsurface Disposal of Industrial Wastes. published and distributed by the Interstate Oil Compact Commission. Oklahoma City, Oklahoma. 1968.
- Le Grand, H. E. Geology and Ground-Water Hydrology of the Atlantic and Gulf Coastal Plain as Related to Disposal of Radioactive Wastes. U. S. Geological Survey Trace Elements Inv. Report 805. 1962.
- Love J. D. and Hoover, L. A Summary of the Geology of Sedimentary Basins of the United States, with Reference to the Disposal of Radioactive Wastes. U. S. Geological Survey Trace Elements Inv. Report 768 (open file). 1960.
- MacLachlan, M. E. The Anadarko Basin (of parts of Oklahoma, Texas, Kansas, and Colorado). U. S. Geological Survey Trace Elements Inv. Report 831. 1964.
- McGinnis, L. D., et. al. The Gravity Field and Tectonics of Illinois, Illinois State Geological Survey Circular 494. 1976. 28 pp
- Newton, V. C., Jr. Geologic Consideration in the Disposal of Chemical and Radioactive Wastes. Oregon Dept. of Geology and Mineral Industries, Portland, Oregon. 1970.
- Ohio River Valley Water Sanitation Commission. Underground Injection of Wastewater in the Ohio Valley Region. ORSANCO. Cincinnati, Ohio. 1973.

- Ohio River Valley Water Sanitation Commission. Evaluation of the Ohio Valley Region Basal Sandstone as a Wastewater Injection Interval. Cincinnati, Ohio. July, 1976.
- Payne, J. N. "The Age of the La Salle Anticline." Transactions of the Illinois State Academy of Sciences. v. 32, no. 2. 1939. pp. 171-173.
- Repenning, C. A. Geologic Summary of the Central Valley of California, with Reference to Disposal of Liquid Radioactive Waste. U. S. Geological Survey Trace Elements Inv. Report 769 (open file). 1961.
- Rudd, N. Subsurface Liquid Waste Disposal and Its Feasibility in Pennsylvania. Pennsylvania Geological Survey, Fourth Series. Environmental Geology Report 3. Harrisburg, Pennsylvania. 1972.
- Sandberg, C. A. Geology of the Williston Basin, North Dakota, Montana, and South Dakota, with Reference to Subsurface Disposal of Radioactive Wastes. U. S. Geological Survey Report TEI-809. 1962.
- Trevorrow, L. E., Warner, D. L., and Steindler, M. J. Considerations Affecting Deep-Well Disposal of Tritium-Bearing Low-Level Aqueous Waste from Nuclear Fuel Reprocessing Plants, ANL-76-76, Argonne National Laboratory, Argonne, Illinois. March, 1977. 190 pp.
- Tucker, W. E. and Kidd, R. E. Deep Well Disposal in Alabama. Alabama Geological Survey Bulletin 104. University of Alabama. 1973.
- U. S. Geological Survey - American Association of Petroleum Geologists. Geothermal Gradient Map of North America. U. S. Geological Survey Branch of Distribution, Arlington, Virginia. 1976.
- Van Everdingen, P. O. and Freeze, R. A. Subsurface Disposal of Waste in Canada. Inland Waters Branch, Department of the Environment. Tech. Bulletin. No. 49. Ottawa, Canada. 1971. 64 pp.
- Warner, D. L. "Subsurface Disposal of Liquid Industrial Wastes by Deep-Well Injection." in Subsurface Disposal in Geologic Basins - A Study of Reservoir Strata. J. E. Galley, ed. A. A. P. G. Memoir 10, Am. Assoc. Petroleum Geologists, Inc., Tulsa, Oklahoma. 1968. pp. 11.
- West, S. W. Disposal of Uranium - Mill Effluent by Well Injection in the Grants Area, Valencia County, New Mexico. U. S. Geological Survey Professional Paper 386-D. 1972.



## CHAPTER 5

### WASTEWATER CHARACTERISTICS

Table 5-1 lists the characteristics of the untreated wastewater that must be considered in evaluating its suitability for disposal by subsurface injection. Preliminary examination of these factors will show, in general, if the effluent is such that more detailed appraisal is warranted. During a detailed study, it is attempted to define all of the design and operational problems related to the wastewater and to provide for these by plant process control, wastewater pre-treatment, design modification, and operational procedure.

As pointed out by Wright (undated), it is not usually necessary for injection purposes to know the exact chemical composition of a wastewater, because empirical tests can be run to determine the reactivity and stability of a waste. However, this information should be obtained so that the environmental effect of the injected fluid can be assessed.

In this chapter, the items in Table 5-1 are discussed individually with regard to their basic nature and, more importantly, with regard to their effect on injection practice.

#### VOLUME

One of the most constraining limitations in managing a wastewater by subsurface injection is the volume that can be safely injected for the desired length of time. This is because the intake rate or life of an individual well is limited by the properties of the injection interval, which cannot be changed much. The variable limiting the injection rate or well life can be the injection pressure required to dispose of the produced waste. Injection pressure is a limiting factor because excessive pressure causes hydraulic fracturing and possible consequent damage to confining strata. In addition, the pressure capacity of injection-well pumps, tubing, and casing is limited.

The initial pressure required to inject waste at a specified rate and the rate at which injection pressure increases with time can be calculated, as is discussed in Chapter 3, if the physical properties of the aquifer and waste are known. The intake rate of most waste-injection wells now in use is less than 400 gpm (Warner and Orcutt, 1972; U. S. Environmental Protection Agency, 1974), but intake rates can be higher in particularly favorable circumstances. The operating life of an injection well may also be related to the volume of injected waste, because the distance injected waste can be

TABLE 5-1. FACTORS TO BE CONSIDERED IN EVALUATING THE SUITABILITY OF UNTREATED WASTES FOR DEEP-WELL DISPOSAL

---

---

- A. Volume
  - B. Physical Characteristics
    - 1. Density
    - 2. Viscosity
    - 3. Temperature
    - 4. Suspended solids content
    - 5. Gas content
  - C. Chemical Characteristics
    - 1. Dissolved constituents
    - 2. pH
    - 3. Chemical stability
    - 4. Reactivity
      - a. With system components
      - b. With formation waters
      - c. With formation minerals
    - 5. Toxicity
  - D. Biological Characteristics
- 
-

allowed to spread laterally may be restricted by law or by other considerations. The storage volume in the vicinity of an injection well can be computed very simply, but dispersion, absorption, and chemical reaction complicate the calculation of the distribution of injected waste. This topic is also discussed in greater detail in Chapter 3.

## PHYSICAL CHARACTERISTICS

### Density

The density of the injected wastewater contributes to the injection pressure by virtue of the pressure developed by the column of water in the well. In some wells, this pressure alone is sufficient to drive the waste into the formation and no pump is needed. In all wells, this pressure component must be included in calculations. Once the wastewater is in the formation, its density affects the manner in which it flows away from the well. Low density wastes tend to float on saline formation waters and flow up-dip, while dense waters sink and tend to flow down-dip.

Various industrial wastewaters have densities that span the full range of possibilities for an aqueous waste. For example, the dissolved solids content of low-level radioactive wastewater from the fuel-reprocessing cycle is so small that it is essentially distilled water with a density of  $1.0 \text{ gm/cm}^3$  (Trevorrow, et. al., 1977). On the other hand, saturated brines from a desalination plant may have densities as high as  $1.15 \text{ gm/cm}^3$  and steel plant waste densities as high as  $1.2 \text{ gm/cm}^3$  (Warner, 1972; U. S. Environmental Protection Agency, 1974).

### Viscosity

As previously discussed in the section on subsurface fluids, viscosity is the ability of a fluid to resist flow, and is one of the fundamental properties that determines the rate of flow of a fluid through a porous medium. Furthermore, in wastewater injection, the ratio of the viscosity of the injected water to the formation water (the mobility ratio) has an important effect on the amount of mixing that occurs between the injected and interstitial water during travel through the injection reservoir. Mixing is greatly increased when the viscosity of the injected fluid is less than that of the interstitial fluid.

As with density, the viscosity of industrial wastes ranges from that of nearly pure water (1 centipoise at  $20.2^\circ\text{C}$ ) to considerably higher values. However, very few measured values of waste viscosity have been obtained in surveys of existing injection wells (Warner, 1973; U. S. Environmental Protection Agency, 1974), so the full range is not well characterized. The viscosity of a waste will increase with increasing dissolved solids content and decrease with increasing temperature. Organic chemicals, in particular may influence fluid viscosity.

## Temperature

Variation in wastewater temperature may affect corrosion rates and other chemical reactions and does affect viscosity as previously explained.

Generally, corrosion rate increases with increasing temperature. This is particularly true when corrosion is due to the presence of mineral acids in water, resulting in hydrogen evolution. However, in waters which are corrosive due to the presence of dissolved oxygen, the corrosion rate in an open system increases with increasing temperature only until the temperature becomes high enough to cause an appreciable decrease in the oxygen solubility. Further temperature increase beyond this value results in a decrease in the corrosion rate for such open systems, where the oxygen is free to escape. In a closed system, the oxygen cannot escape and the corrosion rate continues to increase with increasing temperature (Ostroff, 1965). Wastewater may be in an open system as it passes through the plant and pretreatment process. It will be in a closed system once it enters the well.

As with corrosion, most chemical reactions are enhanced by increase of temperature. According to the general rate constant equation, which can be found in physical chemistry texts, the rate of reaction varies with the logarithm of increasing temperature.

If a wastewater is at ambient temperature prior to injection, its temperature will be increased during injection according to the local geothermal gradient, which was previously defined and discussed in Chapter 2. This should be kept in mind in considering the reactivity of a wastewater.

## Suspended Solids Content

Suspended solids must normally be removed from a wastewater to the highest degree practicable prior to injection, because they will otherwise be filtered out by the reservoir rock and will thus plug the pores and reduce permeability. The plugging effect of suspended solids is inversely related to the size of the pores in the reservoir; however, any sandstone with intergranular permeability will be plugged if a significant amount of suspended solids remains in the wastewater. It is possible for carbonate rocks with solution permeability or fractured reservoirs to accept wastewaters containing suspended material; but this characteristic should not be depended upon and filtration omitted from the pre-injection treatment system, until the capabilities of the injection horizon have been established by testing.

Suspended solids can originate as chemical precipitates, as particles from materials handled in the industrial process, as corrosion reaction products, as clay or silt--perhaps from ore processing, and probably in other ways. Suspended solids content is determined by filtration and is reported in mg/l. The standard filter used for wastewater analysis is a glass fiber filter disk (American Public Health Association, et. al., 1976). This test is a crude one, since wastewater treatment plants demand less than complete particle removal. For injection water, use of a membrane filter with a 0.47 micron pore size is recommended (Ostroff, 1965). Sadow (1972) states that only detailed laboratory testing of core samples or field testing can ra-

ionally define the requirement for solids removal in any particular case.

An indirect indication of suspended solids content is turbidity as determined with some type of turbidimeter. According to the American Public Health Association, et. al. (1976), the optical property of turbidity cannot be directly correlated with suspended solids content, but turbidity measurements provide an inexpensive and continuous means of evaluating the relative clarity of treated injection water. In fact, it is possible to arrange for automatic recycling of the wastewater or shut-down of the injection well if an unacceptable turbidity level is measured in the treated wastewater.

### Gas Content

Entrained gas bubbles can, just as suspended solids, plug the pores of the injection reservoir. Therefore, it may be necessary to degasify some wastewaters to prevent such mechanical plugging. Dissolved gases do not pose any potential for mechanical plugging, but dissolved oxygen, hydrogen sulfide, carbon dioxide, and perhaps other gases promote corrosion of surface and well equipment and may also be involved in reactions that produce plugging precipitates. Degasification to reduce corrosion or to prevent chemical reactions may, therefore, be desirable.

Corrosion of iron by dissolved oxygen in the absence of any other influencing gases or chemicals proceeds as follows (Ostroff, 1965):

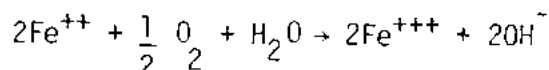
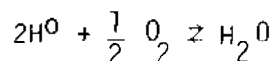

In a closed system (out of contact with air), the reaction will continue only until the dissolved oxygen is consumed. In a system in contact with air, the oxygen supply is replenished and corrosion continues. The surface facilities for an injection system may be open or closed. Once the wastewater enters the injection pump, it is in a closed system. Oxygen has been found to enter supposedly closed systems through loose pump packing and by various other means (Wright, undated).

The presence of dissolved salts enhances corrosion by oxygen, but because solubility of oxygen decreases with increasing salt content, corrosion from oxygen may be less in very highly saline solutions than it is in weakly saline solutions.

Carbon dioxide dissolved in water can contribute to the corrosion of steel, but for equal concentrations it is much less corrosive than oxygen (Ostroff, 1965). Water containing both gases is more corrosive to steel.

than water which contains only an equal concentration of one of these gases (ibid.).

Water containing hydrogen sulfide is corrosive. Dissolved hydrogen sulfide forms a weak acid; and, in the absence of oxygen, dissolved hydrogen sulfide will attack iron and nonacid-resistant alloys. Water containing both oxygen and hydrogen sulfide may even be corrosive to acid-resistant alloys (Ostroff, 1965).

## CHEMICAL CHARACTERISTICS

### Dissolved Constituents

The dissolved chemicals in a wastewater contribute to its properties including reactivity, toxicity, density, and viscosity. As mentioned previously, these resultant properties can be determined without a chemical analysis, but they can be better understood if a complete chemical analysis is available.

A useful measurement of the dissolved chemicals is the total dissolved solids content, often abbreviated as TDS. The total dissolved solids content can be obtained by adding the weights of each of the individual constituents or by evaporating a filtered sample to dryness and weighing the residue. A direct analysis is a good check on the value obtained by adding the results of the other analyses.

An excellent indicator of the total dissolved solids content of an aqueous solution can be its conductivity or resistivity. In chemical solutions containing many ions, it is necessary to develop an empirical relation between dissolved solids content and conductivity, but an estimate of the dissolved solids content can be made using a graph such as that shown in Figure 3-8, which is for sodium chloride solutions. This estimate is less satisfactory when the proportions of different ions vary as well as the concentrations. Conductivity can be monitored as an approximate indicator of variations that may occur in wastewater composition.

Dissolved salts have a marked influence on the corrosivity of water. Both the anion and cation kinds affect the corrosion rate as does concentration. For example, the order of decreasing corrosiveness of cations has been given as ferric > chromic > aluminum > potassium > sodium > lithium > barium > strontium > calcium > manganese > cadmium > magnesium (Borgman, 1937). However, the type of salt in solution is equally as important as the kind of ion (Uhlir, 1963). Alkali metal salts (e. g., NaCl, KCl, Na<sub>2</sub>SO<sub>4</sub>) and acid salts (e. g., FeCl<sub>2</sub>, AlCl<sub>3</sub>) are corrosive to iron. Alkaline salts (e. g., Na<sub>2</sub>CO<sub>3</sub>, Na<sub>3</sub>PO<sub>4</sub>) passivate iron and are corrosion inhibitors above pH 10 and may also act as corrosion inhibitors below pH 10 by forming efficient diffusion barriers such as ferric phosphate. Oxidizing salts may be corrosive (e. g., FeCl<sub>3</sub>, CuCl<sub>2</sub>) or they may be inhibitors (e. g., Na<sub>2</sub>CrO<sub>4</sub>, NaNO<sub>2</sub>, KMnO<sub>4</sub>).

Generally, corrosiveness increases with increasing salt concentration until a maximum is reached, then corrosiveness decreases. The initial increase

in corrosion rate at low salt concentrations is probably a result of conductivity increase. The decrease in corrosion rate at high salt concentrations (> 30,000 mg/l in NaCl) results from the decreased solubility of oxygen (Uhlig, 1963).

Examination of the dissolved solids composition of a wastewater and comparison with the analysis of formation water may indicate the potential for reactions between the two waters. Reactions between injected and interstitial water that form precipitates are undesirable because the precipitates may plug the pores of the injection unit, reducing the porosity and permeability. Selm and Hulse (1959) listed the reactions between injected and interstitial fluids that can cause the formation of plugging precipitates - (1) precipitation of alkaline earth metals such as calcium, barium, strontium, and magnesium as relatively insoluble carbonates, sulfates, orthophosphates, fluorides, and hydroxides; (2) precipitation of metals such as iron, aluminum, cadmium, zinc, manganese, and chromium as insoluble carbonates, bicarbonates, hydroxides, orthophosphates, and sulfides; and (3) precipitation of oxidation-reduction reaction products. Headlee (1950) discussed such reactions in detail.

The dissolved solids in wastewater may also react with formation minerals. The most common reaction of this type is reaction of acidic wastes with carbonate reservoirs as previously mentioned. Ion exchange may also take place. Ion exchange affects the ionic composition of the injected water. This may be a means of selectively removing some ions from the wastewater. For example, radioactive ions may be absorbed and replaced by innocuous ones. Such reactions are discussed further in the section concerning reactions with formation minerals.

### pH

Wastewater pH is an indicator of corrosiveness to equipment and possibly of reactivity with the subsurface reservoir. Wastes with a low pH have been the principal source of injection system failure from corrosion. Acidic wastes also have caused well failures through collapse of the well bore after long periods of erosion due to dissolving of limestone and dolomite in the subsurface reservoir. Some reaction with a carbonate reservoir can, however, be desirable, because it will maintain and even increase the porosity and permeability of such a reservoir.

The corrosiveness of a wastewater to iron generally increases as pH decreases. At very low pH values (less than 4), the iron corrosion products are soluble, resulting in direct contact between the acidic solution and the iron surface and consequent rapid corrosion. In the pH range of 4 to 9.5, the iron surface is coated by corrosion reaction products and corrosion progresses more slowly. However, highly alkaline solutions may also be corrosive. For example, at extremely high concentrations of sodium hydroxide, iron corrodes forming soluble sodium ferrite,  $\text{NaFeO}_2$  (Dettloff, 1964).

Changes in wastewater pH can initiate precipitation of dissolved salts causing plugging of formation pores. For example, increase in the pH of

ferric chloride or ferric sulfate solutions to above pH 4 leads to precipitation of the ferric iron.

An increase in pH of water in the formation pores can also cause loss of permeability in formations that contain so-called "sensitive" clays (Hughes, 1950; Baptist and Sweeney, 1955).

### Chemical Stability

Stability of the chemical compounds in the injected wastewater is desirable. An unstable compound may precipitate during or after injection and cause plugging. The influence of temperature and pH changes in initiating instability have been individually pointed out, but have not been quantified. Also these factors can obviously act simultaneously, making interpretation difficult.

A means of anticipating instability in a system affected by more than one variable is through use of a saturation or stability index. Several such indices have been developed including those by Langelier (1936), Ryznar (1944) Larson and Buswell (1942), and Stiff and Davis (1952). The first three indices are applicable to waters of low ionic strength, while the Stiff and Davis index is intended for use with concentrated solutions, such as highly saline ground waters. As an example of the use of such indices, the Stiff and Davis (1952) stability index for calcium carbonate is:

$$SI = pH - k - pCa - pAlk \quad (5-1)$$

In equation 5-1, k is an empirical constant used to compensate for various ionic strengths and temperatures. The values of k, pCa, and pAlk are taken from graphs (Figures 5-1 and 5-2). A positive index indicates scale formation and a negative index indicates corrosion.

The following example of the use of the stability index was taken from Ostroff (1965).

From the water analysis in Table 5-2, the concentration C of each ion in moles per 1,000 grams of water is calculated using the relationship:

$$C = \frac{\text{epm}}{z(1,000 \text{ SpGr} - \frac{\text{TDS}}{1,000})} \quad (5-2)$$

where epm = concentration of the ion, epm

z = valence of the ion

SpGr = specific gravity of the brine

TDS = total dissolved solids, ppm



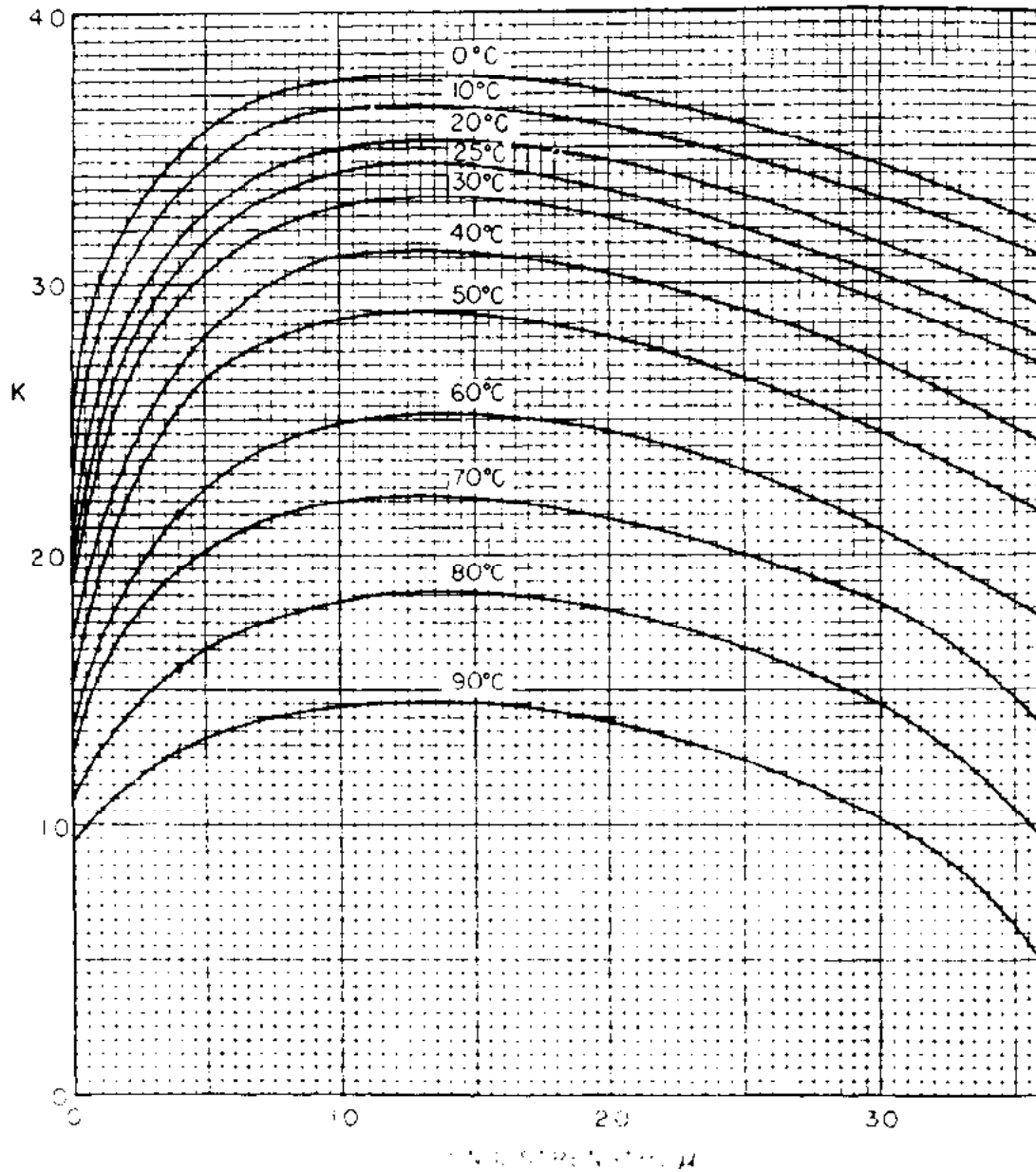

FIGURE 3-1. VALUES OF K AT VARIOUS IONIC STRENGTHS (FROM NEEFF AND DAVIS, 1952).

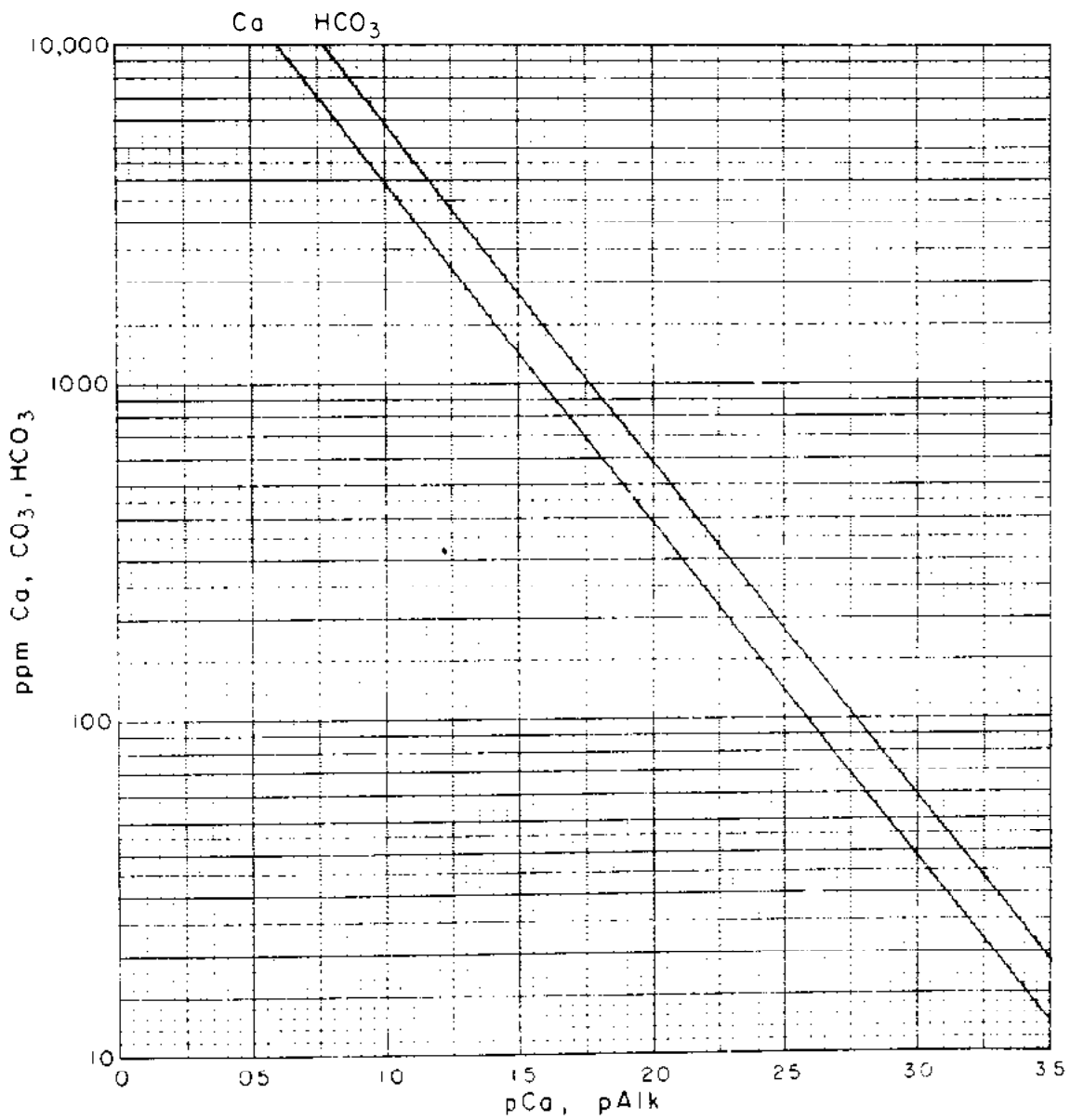

FIGURE 5-2. GRAPH FOR CONVERTING PARTS PER MILLION OF CALCIUM AND ALKALINITY TO pCa AND pAlk (FROM STIFF AND DAVIS, 1952).

This gives the following results:

TABLE 5-2. WATER ANALYSIS USED IN SAMPLE CALCULATION OF CALCIUM CARBONATE SATURATION USING STIFF AND DAVIS INDEX (OSTROFF, 1965)

Component	ppm	epm	Moles/1,000 gm
Carbonate ( $\text{CO}_3^{=}$ )	-	-	-
Bicarbonate ( $\text{HCO}_3^-$ )	46	0.7	0.001
Sulfate ( $\text{SO}_4^-$ )	7,530	158	0.083
Chloride ( $\text{Cl}^-$ )	88,300	2472	2.599
Iron ( $\text{Fe}^{++}$ )	14	0.4	0.000
Calcium ( $\text{Ca}^{++}$ )	8,570	428	0.225
Magnesium ( $\text{Mg}^{++}$ )	2,819	231	0.121
Sodium ( $\text{Na}^+$ )	45,195	1965	2.066

Using these molalities, the ionic strength  $\mu$  is calculated.

$$\begin{aligned} \mu &= \frac{1}{2} (C_1 Z_1^2 + C_2 Z_2^2 + \dots + C_n Z_n^2) \\ &= \frac{1}{2} [(0.001) (1) + (0.083) (4) + (2.599) (1) + (0.225) (4) \\ &\quad + (0.121) (4) + (2.066) (1)] = 3.19 \end{aligned}$$

Then, from Figure 5-1, the value of  $k$ , at  $\mu = 3.19$  and at the analysis temperature of  $77^\circ\text{F}$  ( $25^\circ\text{C}$ ), is found to be 2.96.

The next step is to enter the ppm  $\text{Ca}^{++} = 8,570$  and ppm  $\text{HCO}_3^- = 46$  (obtained from the water analysis) as the ordinate of Figure 5-2. Reading the abscissa, the  $\text{pCa}$  of 0.67 and the  $\text{pAlk}$  is 3.12.

Then, substituting in Equation 5-1, the stability index is calculated as follows:

$$SI = \text{pH} - k - \text{pCa} - \text{pAlk} = 6.1 - 2.96 - 0.67 - 3.12 = -3.65$$

This indicates that the water is corrosive and also undersaturated with respect to calcium carbonate.

Ostroff (1965) discusses the stability of magnesium carbonate, magnesium hydroxide, calcium sulfate, barium sulfate, iron, and also silica. Barnes (1972) suggests a thermodynamic approach to predicting the stability of inorganic compounds in solution.

Dissolved organic compounds may also be unstable. Selm and Hulse (1959) list polymerization of organic chemicals as a source of plugging precipitates.

In addition to the predictive methods of analyzing for chemical stability, analysis can be empirical. The water in question can be subjected to the pressure and temperature that it will experience in the subsurface and it can then be observed to evaluate its tendency to form precipitates over an extended period of time.

### Reactivity

Wastewater can react with the materials in the mechanical system, aquifer fluids, and aquifer minerals. As has been described previously in this chapter, knowledge of the chemistry of the wastewater along with the materials of construction, the chemistry of aquifer fluids, the mineralogy of the injection horizon and the subsurface temperature and pressure allow prediction of some potential reactions. Further discussion of the problems of reactivity and prediction of their likelihood of occurrence is given in this section.

#### Reaction with System Components --

Corrosion of metals in injection systems may be by chemical, electrochemical, or microbiological means. In aqueous systems, corrosion is principally electrochemical. Some factors that influence electrochemical corrosion of steel are dissolved oxygen, dissolved salts, pH, temperature, pressure, and flow rate of the corroding solution. The influence of all but flow rate have previously been discussed in this chapter. Generally, corrosion rates increase with the velocity of flow of the corroding water, but not uniformly, because effects such as turbulence and the mechanical removal of corrosion products become involved at high velocities (Ostroff, 1965).

Forms of corrosion include uniform or thinning corrosion, pitting corrosion, intergranular corrosion, and galvanic corrosion (Ostroff, 1965). Uhlig (1963) also includes dezincification and parting and cracking, and Henthorne (1972) adds erosion corrosion and crevice corrosion. In uniform corrosion, the entire surface of the metal is corroded and thinned by a uniform amount. Rate of uniform corrosion is reported in inches per year (ipy), mills per year (mpy, one mill = 0.001 inches), or milligrams per square decimeter per day (mdd). According to Uhlig (1963) steel, for example, corrodes at a relatively uniform rate in sea water equal to about 25 mdd or 5 mpy. Conversion of weight loss to depth of attack or vice versa requires knowledge of metal density. Table 5-3 provides this information.

TABLE 5-3. DATA FOR CONVERSION OF WEIGHT LOSS TO DEPTH OF CORROSION AND VICE VERSA. TO OBTAIN DEPTH OF PENETRATION, MULTIPLY mdd BY 0.00144/DENSITY TO OBTAIN INCHES PER YEAR. TO CONVERT FROM ipy TO mg PER SQ. DECIMETER PER DAY (mdd) MULTIPLY BY 696 X DENSITY (UHLIG, 1963).

Metal	Density gm/cc	$\frac{0.00144}{\text{Density}}$	696 X Density
Aluminum	2.72	0.000529	1890
Brass (red)	8.75	0.000164	6100
Brass (yellow)	8.47	0.000170	5880
Cadmium	8.65	0.000167	6020
Columbium	8.4	0.000171	5850
Copper	8.92	0.000161	6210
Copper-nickel (70-30)	8.95	0.000161	6210
Iron	7.87	0.000183	5480
Iron-silicon (Duriron) (84-14.5)	7.0	0.000205	4870
Lead (chemical)	11.35	0.000127	7900
Magnesium	1.74	0.000826	1210
Nickel	8.89	0.000162	6180
Nickel-copper (Monel) (70-30)	8.84	0.000163	6140
Silver	10.50	0.000137	7300
Tantalum	16.6	0.0000868	11550
Titanium	4.54	0.000317	3160
Tin	7.29	0.000198	5070
Zinc	7.14	0.000202	4970
Zirconium	6.45	0.000223	4490

Metals can be classified according to their corrosiveness and their suitability for various applications as shown below (Uhlig, 1963):

(1) < 0.005 ipy

Metals in this category have good corrosion resistance to the extent that they are suitable for critical parts, e. g., valve seats, pump shafts, springs, etc.

(2) 0.005 to 0.05 ipy

Metals in this group are satisfactory if a higher rate of corrosion can be tolerated; e. g., for tanks, piping, valve bodies, etc.

(3) > 0.05 ipy

Usually not satisfactory.

In pitting corrosion, attack is greater in localized areas than over the surface as a whole. Depth of pitting is sometimes expressed by a pitting factor, which is the ratio of the deepest pits to the average depth of corrosion as determined by weight loss. Ostroff (1965) gives a laboratory procedure for performance of a weight loss test.

Intergranular corrosion occurs with alloys when a difference in potential exists between the grain boundary and the grain. The smaller grain boundary acts as the anode. This type of corrosion is particularly serious with aluminum alloys containing copper and austenitic stainless steels containing carbon.

Galvanic corrosion occurs where two different metals or alloys come in contact. The severity of galvanic corrosion depends upon the difference in potential between the two metals, and the relative size of the cathode and anode areas. The galvanic series for metals and alloys in sea water is shown in Table 5-4. Active metals are at the top of the series. Coupling a metal near the top with one near the bottom will cause galvanic corrosion of the more active metal.

If the area of the active metal is very large compared with the area of the less active metal, corrosion will not be so severe. Polarization will also modify the amount of current flowing during the corrosion reaction.

In addition to visual observation and weight loss testing, corrosion rates can be measured or estimated by use of electrical resistance corrosion probes, and by analysis of the corroding water for corrosion products. Well casing or tubing can also be examined in place for corrosion with caliper logs, electromagnetic logs, televiewer logs, and down-hole television inspection. The borehole methods are discussed in Chapters 3 and 7.

Electrical resistance corrosion probes depend on measuring the change in resistance of a metal specimen as it loses volume through corrosion.

TABLE 5-4. GALVANIC SERIES FOR METALS IN SEA WATER (JELLINKE, 1958).

Active or Anodic End
Magnesium
Zinc
Alclad 3S
Aluminum 3S
Aluminum 61S
Aluminum 63S
Aluminum 52
Low steel
Alloy steel
Cast iron
Stainless steels (active)
Type 410
Type 430
Type 304
Type 316
Ni-resist
Muntz metal
Yellow brass
Admiralty brass
Aluminum brass
Red brass
Copper
Aluminum bronze
Composition G bronze
90/10 Copper-nickel
70 + 30 Copper-nickel-low iron
70 + 30 Copper-nickel-high iron
Nickel
Inconel
Silver
Stainless steels (passive)
Type 410
Type 430
Type 304
Type 316
Monel
Hastelloy C.
Titanium
Noble or Cathodic End

Probes are available in a variety of metals and alloys. Commercial measuring instruments are also available for use in conjunction with the probes. Corrosion prevention is covered in conjunction with wastewater pretreatment and system design.

Microorganisms can contribute to corrosion in several ways, one of which will be described. Although many types of bacteria can contribute to corrosion, only a few have been found to be of major importance in oil field operations (Sharpley, 1961), which are similar to disposal well operations.

Sulfate-reducing bacteria (Desulfovibrio desulfuricans) are common and the most important from a corrosion standpoint. They are an anaerobic bacteria, but will survive in the presence of dissolved oxygen, where they may grow under scale, debris, or other bacterial masses where oxygen cannot penetrate (Baumgartner, 1962). In the process of reducing sulfur in sulfate ions to the sulfide form, these bacteria utilize hydrogen which increases corrosion by depolarizing the cathode in an electrochemical system. The sulfide ion resulting from sulfate reduction can combine with ferrous iron at the anode, forming ferrous sulfide, a commonly observed plugging precipitate.

A possible reaction between radioactive wastewater and metals in the injection system is the selective deposition of radioactive metals in place of the inert metals in the system. This process would cause the system components to become radioactive and possibly present some special problems in their handling. Trevorrow et. al. (1977) discuss the potential for this problem in conjunction with injection of low-level radioactive waste from nuclear fuel reprocessing plants.

#### Reaction with Formation Waters --

The potential reactions from mixing of injected and interstitial waters have been discussed in the section entitled "Dissolved Constituents." Waters that can be mixed without the formation of precipitates are termed compatible. Henkel (1953, 1955) reported testing brine and wastewater compatibility by allowing a mixture of the two liquids to stand for from 8 to 24 hours at the approximate aquifer temperature. The mixture is considered compatible if it remains free of precipitates. Others (Lansing and Hewett, 1955; MacLeod, 1961) have suggested that this criterion may not be entirely satisfactory in all cases, since reactions may require considerable time for completion and because gaseous reaction products may also cause reduction in permeability. Ostroff (1965) describes a procedure for compatibility testing and notes that it may be necessary to observe the test for a considerable length of time if an induction period is required before the formation of precipitates. Ostroff also suggests that, if the possibility of reaction is suspected but not observed, it is advisable to seed the water with crystals of the salt that is most likely to deposit to stimulate the suspected reaction.

In testing for compatibility, the use of water from the proposed injection interval rather than a synthesized formation water is recommended, if possible, since even small differences in water chemistry can cause unexpected reactions (Lansing and Hewett, 1955). In addition, synthesizing a



particular formation water in the laboratory may be impossible, because natural brines apparently supersaturated in certain salts are not uncommon (Le-welling and Kaplan, 1959).

#### Reactions with Formation Minerals --

A small number of minerals comprise nearly the entire mass of sandstone aquifers. The average sandstone, as determined by Clarke (1924), consists of 66.8 percent  $\text{SiO}_2$  (mostly quartz), 11.5 percent feldspars, 11.1 percent carbonate minerals, 6.6 percent micas and clays, 1.8 percent iron oxides, and 2.2 percent other minerals. Limestone and dolomite aquifers are primarily  $\text{CaCO}_3$  and  $\text{CaMg}(\text{CO}_3)_2$ , respectively, but impure ones may contain as much as 50 percent noncarbonate constituents such as  $\text{SiO}_2$  and clay minerals.

Quartz, the main constituent of sandstones, is the least reactive of the common minerals, and for all practical purposes can be considered non-reactive except in highly alkaline solutions (Roedder, 1959). Clays have been demonstrated to react with highly basic or highly acidic solutions (Grim, 1953; Nutting, 1943; Murata, 1943). A waste would not necessarily need to be highly acidic to attack an aquifer mineral, since some relatively weak acids may strongly attack certain clay minerals (Grim, 1953; Nutting, 1943). The degree of reaction of feldspars and micas with injected solutions is not certain, but some reaction would no doubt occur (Roedder, 1959).

Sandstone aquifers are often cemented with carbonate minerals, which react with acid solutions. Reaction of acid wastes with the carbonate cement in sandstone would cause an evolution of  $\text{CO}_2$  that could both increase the pressure and reduce permeability. In the special case of acid aluminum nitrate wastes, Roedder (1959) has shown that the reaction of the waste with  $\text{CaCO}_3$  results in a gelatinous precipitate that would plug the pores in a sandstone containing sufficient carbonate minerals. Sandstones also commonly contain gypsum and limonite as cementing material, and these two minerals can be dissolved and reprecipitated to cause blocking of pores (Yuster, 1939; Krynine, 1938).

The brines in deep limestone, dolomite, or calcareous sandstone aquifers will, in most cases, be in chemical equilibrium with the aquifer, and precipitation or solution will not occur.

If injected wastes are at a lower pH than aquifer waters, solution of the carbonate aquifer material may occur. This reaction could be beneficial, as long as no gelatinous precipitates result, such as those that occur when acid aluminum nitrate wastes react with  $\text{CaCO}_3$ . If injected wastes mix with aquifer water and raise its pH, dissolved salts could precipitate and cause plugging of the pores.

Clay minerals are common constituents of sedimentary rocks. Roedder (1959) stated that sandstones containing less than 0.1 percent clay minerals may not exist anywhere in the United States, except possibly in small deposits of exceedingly pure glass sand. Clay minerals are known to reduce the permeability of sandstone to water as compared with its permeability to air (Johnston and Beeson, 1945; Baptist and Swenson, 1945; Land and Baptist,

1965). The degree of permeability reduction to water as compared with air is termed the water sensitivity of a sandstone by Baptist and Sweeney.

The water sensitivity of clay-bearing sandstones increases with decreasing water salinity, decreasing valence of the cations in solution, and increasing pH of the water (Johnston and Beeson, 1945; Hughes and Pfister, 1947; Baptist and Sweeney, 1955). Jones (1964) described work where he gradually reduced the salt concentration of brines during flow tests in clay-containing rocks. He found that water permeabilities remained essentially constant with this procedure, in contrast to the drastic permeability decrease which would occur if the salt concentration were changed to the final low value in one step. Mungan (1965) confirmed Jones' findings and also investigated the effect of pH on permeabilities. Generally, high-pH solutions caused severe permeability damage, particularly where a large change in pH of flowing solutions was noted. Browning (1964) had also noticed this effect where hydroxyl ions promoted the cleavage of clay-mineral stacks. One interesting observation by Mungan was the silica enrichment of the effluent from the cores. He believed that amorphous silica was being dissolved by the high-pH solutions and, because this silica might be the cementing agent for sand grains, fines could be released to migrate and, eventually, to obstruct flow passages. Permeability damage caused by the high-pH solutions was more noticeable at higher temperatures. The water sensitivity of a sand depends on the type of clay mineral as well as the amount. Hughes (1950) pointed out that the properties that cause clay minerals to reduce sandstone's permeability to water are exhibited by montmorillonite to a marked degree, by illite to a lesser degree, and by kaolinite to a relatively unimportant degree. Concepts that can be used to explain the above-mentioned observations have been discussed by Van Olphen (1963). Water sensitivity of sandstones can be determined directly by permeability tests with various waters and air or indirectly by X-ray diffraction, differential thermal analysis, or water vapor absorption measurements (Baptist and Sweeney, 1955; Johansen and Dunning, 1958).

Hewitt (1963) developed a series of tests that detect the degree of water sensitivity of rocks. His system includes mineral identification, solids-swelling tests, microscopic examination, and flow tests. The complete program requires specialized equipment, expertise in this area, and considerable time, but the data obtained can be of considerable value.

Repairing permeability damage after a water-sensitive rock has been exposed to a brine of lower salinity is normally difficult. Hower, et. al. (1972) suggest that this is because when the normally-stacked clay crystals adsorb additional water, they tend to separate and build a "house of cards" structure. Such a structure develops through the attraction of the positively charged edges of the clay crystals to the negatively charged faces. When the salt content of the brine is then increased to the original concentration, the crystals are not restacked in an orderly manner but attain a compressed "house of cards" configuration.

Hower et. al. (1972) point out that polar organic compounds can be adsorbed on surfaces of rocks, particularly the silicates. Silicates, in their natural state, are negatively charged and will adsorb organics through

electrostatic attraction, hydrogen bonding, and van der Waals forces. The greatest charge density is normally found on clays, particularly the montmorillonite and mixed-layer clays, which would make the electrostatic attraction force the greatest for these minerals. It has been shown (Hower, 1970) that up to 0.55 g of some surfactants can be adsorbed by 1 g of montmorillonite. Quartz has a much lower charge density, but it can also adsorb a significant quantity of positively charged organic chemicals. It is possible to alter the wettability of some rocks from water-wet to oil-wet by adsorption. This change in wettability and/or extensive adsorption of other polar organic chemicals on the rock around the well bore may cause severe permeability reduction. Some of these adsorbed chemicals can be washed from the rock with water, whereas others, particularly those carrying a positive charge, are very difficult to remove. In some cases, a specific solvent can be used to dissolve the adsorbed organics. The problems relating to permeability reduction by polar organic adsorption are normally more severe in sandstone than in carbonate reservoir rocks.

### Toxicity

Toxic chemicals are defined in the Federal Water Pollution Control Act Amendments of 1972 as those pollutants or combinations of pollutants, including disease causing agents, which after discharge and upon exposure, ingestion, inhalation or assimilation into any organism, either directly from the environment or indirectly through food chains, will, on the basis of the information available, cause behavioral abnormalities, cancer, genetic mutations, physiological malfunctions or physical deformations in such organisms or their offspring.

Sources of information on the toxicity of inorganic and organic chemicals include "Clinical Toxicology of Commercial Products" (Gleason, et. al., 1969), the "Toxic Substances List" (Christensen, et. al., 1974), "Water Quality Criteria" (McKee and Wolf, 1963) and "Water Quality Criteria" (Federal Water Pollution Control Administration, 1968), "Water Quality Criteria-1972" (National Academy of Sciences, 1974) and "Quality Criteria for Water" (U. S. Environmental Protection Agency, 1976).

Also, the National Technical Information Service of the U. S. Department of Commerce, Springfield, Virginia, maintains a Toxicology Information Response Center and the Library of Congress (1969) has published a document entitled, "A Directory of Information Resources in the United States - General Toxicology." In the event that chemicals are involved for which there is no toxicity information, consultants are available to make the necessary toxicity evaluation.

It is suggested that all wastes to be injected should be characterized as to their toxicity, particularly to humans. It is not intended or expected that an injected wastewater will ever enter the biosphere, but the injector and the regulatory authorities should be aware of its toxicity so that appropriate precautions can be provided for in the design, operation, and monitoring of the system.

A scheme for rating the toxicity of a compound that is used by Gleason, et. al. (1969), is shown below:

#### TOXICITY RATING CHART

Toxicity Rating or Class	Probable LETHAL Dose (human) mg/kg	for 70 kg man (150 lb)
6 super toxic	less than 5	a taste (less than 7 drops)
5 extremely toxic	5-50	between 7 drops and 1 teaspoonful
4 very toxic	50-500	between 1 teaspoonful and one ounce
3 moderately toxic	500-5,000	between 1 ounce and 1 pint (or 1 lb)
2 slightly toxic	5,000-15,000	between 1 pint and 1 quart
1 practically non-toxic	above 15,000	more than 1 quart

This chart classifies compounds according to the probable amounts that constitute a lethal dose to a human. As discussed above, it is not expected that an injected waste will ever be ingested by a human. However, it would be apparent to both regulator and injector that no margin for error exists in the handling of super-toxic solutions. On the other hand, it might be judged reasonable to permit some calculated amount of risk when dealing with a non-toxic solution such as a sodium chloride brine.

#### BIOLOGICAL CHARACTERISTICS

Bacteria present in injected wastewater may themselves cause corrosion or plugging of conduits and reservoir rocks. The role of bacteria in corrosion has previously been discussed. Bacteria may also promote reactions within the wastewater that may change the wastewater chemistry and form precipitates or gases.

Microorganisms can contribute to plugging injection wells and fouling flow lines and equipment in several different ways. By actual growth, these organisms can produce masses that will plug wells and reduce flow in lines. Iron bacteria can cause the precipitation of iron as ferric oxide, resulting in an accumulation of this material in injection wells. Corrosion products resulting from increased corrosion caused by sulfate-reducing bacteria can also accumulate in wells or on filters, reducing flow or causing plugging.

The microorganisms mentioned as causing microbiological corrosion can grow into sufficiently large masses to cause plugging. This is particularly true of the slime formers and iron bacteria. In addition, algae may grow in fresh-water systems. Algae require sunlight for growth, so that problems with algae are confined to injection systems where open ponds or holding tanks are used. Fresh-water algae grow on the surface of the water and may serve as a source of food for bacteria. If they form a blanket over a pond or tank, the reduction in oxygen intake into the water can make conditions ideal for growth of sulfate reducers in the areas of deep water. Algae growths often slough off and plug pipes and filters.

DiTommaso and Elkan (1973) reported having discovered the presence of bacteria in the sandstone injection interval of the Hercules Chemical, Inc., plant at Wilmington, North Carolina. In that case, an organic wastewater, the by-product of dimethylterephthalate, was injected and subsequently decomposed to form methane at the expense of dissolved organic carbon. Large increases in the iron content of water in the reaction zone were also observed. The potential implications of such reactions have not been explored, but they could be beneficial, e. g., decomposition of the injected waste or they could be detrimental, e. g., plugging of the aquifer.

Procedures for testing of waters for the presence of microorganisms are given by the American Public Health Association (1976), the American Petroleum Institute (1965), and Ostroff (1965). Ehrlich (1972) comments that the following points should be considered when designing a testing program:

1. The bacterial-growth potential of undiluted waste solution and mixtures of waste solution and native formation water should be determined.
2. Material from the formation, preferably from well cores, should be added to the test solutions.
3. Oxidation-reduction potentials of the test solutions should be adjusted to values which are typical of the formation. Oxygen should be excluded from the solutions if appropriate.
4. The test should be conducted at temperatures and pressures that approximate the operating conditions expected under waste injection.

Ostroff (1965) notes that the mere presence of bacteria in a water does not necessarily mean that they will cause a problem in the injection system. Determination of the potential for engineering problems is linked to the ability of the bacteria present to flourish in the environment of the injection system. Conversely, low bacterial counts do not necessarily mean that bacteria are not a problem, since they may be thriving in an isolated location. Thus, there can be a lack of correlation between bacterial analyses and the damage that may occur in a system.

## WASTEWATER SAMPLING AND ANALYSIS

Thus far, in this chapter, the focus of the discussion has principally related to the influence of the various physical, chemical, and biological characteristics of wastewater upon the injection system and injection operations. Some mention of testing procedures has been made, where the methods are unusual and/or are importantly related to the usefulness of the resulting data for injection purposes. Wastewaters under consideration for injection should be more broadly characterized than has yet been indicated, because alternative forms of handling must be examined before injection is selected and because more information may be needed to plan a pre-injection treatment process.

Conway (1968) listed the basic parameters for the characterization of a wastewater in terms of its source, flow, physical properties, chemical composition, and biological effects (Table 5-5). Table 5-5 overlaps Table 5-1, but it also contains items not included in Table 5-1 that are needed for the purposes mentioned above.

Little mention has been made of sampling procedures. Wastewater analyses are only meaningful if the waste has been properly sampled. Acceptable sampling methods are outlined in "Standard Methods for the Examination of Water and Wastewater" (American Public Health Association, et. al., 1976) and the American Society for Testing and Materials, Part 31, "Water" (1975). Conway (1968) lists some common sampling pitfalls as: insoluble components not collected in proper proportion to sample volume, peak discharges missed by collecting grab samples instead of using compositing equipment, samples not composited in proportion to flow rate and samples not properly preserved.

Excellent references are available that outline currently acceptable methods for wastewater analysis. The analytical methods handbook of the water supply and wastewater control professions is "Standard Methods for the Examination of Water and Wastewater" (American Public Health Association, et. al., 1976). The United States Environmental Protection Agency (1971) has published a manual of analytical procedures selected for use by that agency. Because either State or Federal permits will be required for injection wells, approved analytical methods should be used. The American Society for Testing and Materials (1976) describes procedures accepted by that organization. Other useful references that discuss methods for water analysis are Collins (1975), the American Petroleum Institute (1968), and publications of the United States Geological Survey Water Resource Investigation Series, for example, ones by Barnett and Mallory (1971) and Goerlitz and Brown (1972).

## WASTEWATER CLASSIFICATION

After the physical, chemical, and biological characteristics of a wastewater have been evaluated, as described in Chapter 5, it can be classified for injection purposes. From an engineering viewpoint, the question is: Can the wastewater be safely, efficiently, and economically injected at the available site? Two additional questions that should be addressed from both an engineering and a regulatory position are: Is injection the

TABLE 5-5. BASIC PARAMETERS FOR CHARACTERIZATION  
OF A WASTEWATER (CONWAY, 1968).

- 
- I. Source Information for the Individual Points of Origin
    - (A) Rate of discharge during production run (average and maximum)
    - (B) Duration and frequency of production runs
    - (C) Waste components (see below)
    - (D) Likelihood of spills or abnormal discharges
  - II. Flow Data for Total Discharge
    - (A) Average daily flow rate
    - (B) Duration and level of maximum flow rate
    - (C) Maximum rate of change of flow rate
  - III. Physical Properties
    - (A) Temperature range
    - (B) Insoluble components: colloidal, settleable, floatable
    - (C) Color
    - (D) Odor
    - (E) Radioactivity
    - (F) Foamability
    - (G) Dissolved oxygen
    - (H) Corrosiveness
  - IV. Chemical Composition
    - (A) Known organic and inorganic components
    - (B) Chemical oxygen demand, total carbon, extractables
    - (C) pH, acidity, alkalinity
    - (D) Oxidizing or reducing agents (sulfides)
    - (E) Chloride ion
    - (F) Hardness (calcium and magnesium)
    - (G) Nitrogen and phosphorus
    - (H) Surfactants
    - (I) Chlorine demand
    - (J) Total dissolved salts
    - (K) Specific ions (As, Ba, Cd, Cr, CN, F, Pb, Se, Aq)
    - (L) Phenol
    - (M) Grease and hydrocarbons
  - V. Biological Effects
    - (A) Biochemical oxygen demand
    - (B) Pathogenic bacteria
    - (C) Chemical toxicity (aquatic life, bacteria, plants, man)

most environmentally and technologically desirable alternative in the specific case? Injection may be technically and economically feasible, but still may not be the most desirable alternative.

The procedure for examining the engineering feasibility is to consider each of the characteristics discussed in this chapter and to evaluate their effect on injection at the site in question. Unfortunately, there is no simple basis for ranking all of the factors to arrive at a quantitative value that determines whether or not injection is feasible. Also, if a problem exists, it may be possible to alleviate it by process modification, wastewater pretreatment, or appropriate system design. There are few, if any, wastewater characteristics that cannot be modified to render a liquid injectable. However, the desirability of injection as an alternative will be compromised if too extensive pretreatment or too elaborate system design are required. For example, wastewater volume is one of the most constraining characteristics and usually the first to be examined when considering injection. When the wastewater volume is too great to be accommodated by the locally available injection intervals, possible solutions include modifying the waste producing processes to reduce the volume, separation of waste streams and injection of only selected ones, or a pretreatment step for volume reduction. The volume problem has frequently been solved by one of the first two possible means. Pretreatment for volume reduction is much less promising because the available processes, e. g., partial evaporation, reverse osmosis, and electrodialysis are expensive.

If it is determined that a wastewater is injectable, then the relative desirability of injection, as compared with other alternatives, should also be considered. This has been recognized by many. The Ohio River Valley Water Sanitation Commission (1973), in adopting policy to guide the eight member states, has stated:

"NOW, THEREFORE: Let it be resolved that the Ohio River Valley Water Sanitation Commission does declare as a policy that wastewater injection may be used when the regulatory authorities with legal jurisdiction have considered other alternative methods of waste management, and that, after weighing all available evidence, have determined that:

- I. Underground injection is the best available alternative in the specific circumstances of the case."

Comparison with other alternatives is desirable because, as was recognized some time ago by the Subcommittee on Waste Disposal of the Committee on Sanitary Engineering and Environment, National Academy of Sciences-National Research Council (Committee Reports, June 25, 1962 and January 20, 1964), the injection of liquid wastes into a subsurface rock formation constitutes the utilization of limited useful space, injection wells cannot be considered for any type and quantity of waste. This question has occasioned suggestions that many varieties of wastewaters that are produced should be categorized with regard to their suitability for injection (Warner, 1965; Cleary and Warner, 1969).



Radioactive wastes have been classified according to their relative radioactivity as high, medium, or low level by the U. S. Atomic Energy Commission (1969) and a more comprehensive scheme using five categories has been proposed by the American Institute of Chemical Engineers (1967). For a variety of technical and policy reasons, only the low level radioactive wastes are currently considered likely to be disposed through injection wells (Belter, 1972). Piper (1970) proposed a classification similar to that used for radioactive wastes for all industrial wastes. Van Everdingen and Freeze (1971) expanded upon Piper's concept and also introduced the idea of "natural" and "foreign" wastes. The Piper and Van Everdingen and Freeze classifications are, however, based principally upon waste toxicity and have not received significant support, as far as is known. This is because the other physical, chemical, and biological characteristics must also be rated as should the potential for treatment or disposal by other means.

In summary, a complete basis for classification of a wastewater for injection remains to be devised, but the characteristics described in this chapter are used on a judgemental basis for making this determination. If injection is considered technically feasible, then other means of treatment or disposal are compared to establish that injection is the best alternative in the specific case.

## REFERENCES

### CHAPTER 5

- American Institute of Chemical Engineers. Proposed Definition of Radioactive Waste Categories. Approved, United States of America Standards Institute. June 7, 1967.
- American Petroleum Institute. Recommended Practice for Analysis of Oil Field Waters. API, 2nd ed. American Petroleum Institute, Dallas, Texas. 1968. 49 pp.
- American Petroleum Institute. Recommended Practice for Biological Analysis of Subsurface Injection Waters. API RP38. The American Petroleum Institute, Dallas, Texas. 1965.
- American Public Health Association, American Water Works Association, and Water Pollution Control Federation. Standard Methods for the Examination of Water and Wastewater. 14th edition. American Public Health Association, Washington, D. C. 1976.
- American Society for Testing and Materials. Water. ASTM Standards, Part 31. American Society for Testing and Materials, Philadelphia, Pennsylvania. 1976.
- Baptist, O. C., and Sweeney, S. A. Effect of Clays on the Permeability of Reservoir Sands to Various Saline Waters. Wyoming, U. S. Bureau Mines Rept. Inv. 5180. 1955. 23 pp.
- Barnes, Ivan. "Water-Mineral Reactions Related to Potential Fluid-Injection Problems." in Underground Waste Management and Environmental Implications. T. D. Cook, ed. American Association Petroleum Geologists Memoir 18. AAPG, Inc., Tulsa, Oklahoma. pp. 294-297.
- Barnett, P. R., and Mallory, E. C. "Determination of Minor Elements in Water by Emission Spectroscopy." Chapter A2, Book 5. Techniques of Water-Resources Investigations of the United States Geological Survey. U. S. Government Printing Office, Washington, D. C. 1971. 31 pp.
- Baumgartner, A. V. "Microbiological Corrosion." in Proceedings Fifth Biennial Secondary Recovery Symposium. Society of Petroleum Engineers. May 5-7, 1962.

- Belter, W. G. "Deep Disposal Systems for Radioactive Wastes." in Underground Waste Management and Environmental Implications. T. D. Cook, ed. American Association Petroleum Geologists Memoir 18. A.A.P.G., Tulsa, Oklahoma. 1972.
- Borgman, C. W. "Initial Corrosion Rate of Mild Steel, Influence of the Cation." Industrial and Engineering Chemistry. Vol. 29. 1937. pp. 815.
- Browning, W. C. "The Hydroxyl Factor in Shale Control." Journal Petroleum Technology. Vol. 16, No. 10. 1964. pp. 1177-1186.
- Christensen, H. E., et. al. The Toxic Substances List 1974 Edition. U. S. Department of Health, Education, and Welfare, Public Health Service, Rockville, Maryland. 1974.
- Clarke, F. A. Data of Geochemistry. U. S. Geol. Survey Bull. 770. 1924. 841 pp.
- Cleary, E. J., and Warner, D. L. Perspective on the Regulation of Underground Injection of Wastewaters. Ohio River Valley Water Sanitation Commission Cincinnati, Ohio. 1969.
- Collins, A. G. Geochemistry of Oilfield Waters. Elsevier Publishing Co., New York. 1975. 496 pp.
- Conway, R. A. "Treatment of Dilute Wastewater" in Industrial Waste Disposal. R. D. Ross, ed. Reinhold Book Corp., New York. 1968. pp. 101-143.
- DiTommaso, A., and Elkan, G. H. "Role of Bacteria in Decomposition of Injected Liquid Waste at Wilmington, North Carolina." in Underground Waste Management and Artificial Recharge. Jules Braunstein, ed. American Association Petroleum Geologists, Tulsa, Oklahoma. 1973. pp. 585-602.
- Ehrlich, G. G. "Role of Biota in Underground Waste Injection and Storage." in Underground Waste Management and Environmental Implications. T. D. Cook, ed. American Association Petroleum Geologists, Tulsa, Oklahoma. 1972. pp. 298-307.
- Federal Water Pollution Control Administration. Water Quality Criteria. Report of the National Technical Advisory Committee to the Secretary of the Interior. U. S. Government Printing Office, Washington, D. C. 1968.
- Gleason, M. N., et. al. Clinical Toxicology of Commercial Products. The Williams and Wilkins Company, Baltimore, Maryland. 1969.
- Goerlitz, D. E., and Brown, Eugene. "Methods for Analysis of Organic Substances in Water." Chapter A3, Book 5. Techniques of Water Resource Investigations of the United States Geological Survey. U. S. Government Printing Office, Washington, D. C. 1972. 40 pp.

- Grim, R. E. Clay Mineralogy. McGraw-Hill Book Co., New York, New York. 1953. 384 pp.
- Headlee, A. J. W. "Interactions Between Injected and Interstitial Water -- A Review." in Secondary Recovery of Oil in the United States. 2nd Edition, Part 2. American Petroleum Institute, New York. 1950. p. 240.
- Henkel, H. O. "Surface and Underground Disposal of Chemical Wastes at Victoria, Texas." Sewage and Indus. Wastes. Chemical Eng. Progress. Vol. 25, No. 9. 1953. pp. 1044-1049.
- Henkel, H. O. "Deep-Well Disposal of Chemical Wastes." Chem. Eng. Progress. Vol. 51, No. 12. 1955. pp. 551-554.
- Henthorne, M. "Understanding Corrosion." Chemical Engineering - Deskbook Issue. December 4, 1972. pp. 19-30.
- Hewitt, C. H. "Analytical Technique for Recognizing Water-Sensitive Reservoir Rocks." Journal Petroleum Technology. Vol. 15, No. 8. 1963. pp. 813-818.
- Hower, W. F. "Adsorption of Surfactants on Montmorillonite." Clays and Clay Minerals. Vol. 18. 1970. pp. 97-105.
- Hower, W. F., Lasater, R. M., and Mihram, R. G. "Compatibility of Injection Fluids with Reservoir Components." in Underground Waste Management and Environmental Implications. Amer. Assoc. of Petroleum Geologists Memoir 18. AAPG, Inc., Tulsa, Oklahoma. 1972. pp. 287-293.
- Hughes, R. V. and Pfister, R. J. "Advantages of Brines in Secondary Recovery of Petroleum by Water-Flooding." American Inst. Mining Metall. Engineers Trans., Petroleum Div. Vol. 170. 1947. pp. 187-201.
- Jellinek. "How Oxidative Corrosion Occurs." Chemical Engineering. Vol. 65, No. 17. August 25, 1958. pp. 125-130.
- Johansen, R. T., and Dunning, H. N. Direct Evaluation of Water Sensitivity of Reservoir Rocks. U. S. Bureau Mines Rept. Inv. 5422. 1958. 9 pp.
- Johnston, N., and Beeson, C. M. "Water Permeability of Reservoir Sands." Trans. Amer. Inst. Mining Metall. Engineers. Vol. 160. 1945. pp. 43-55.
- Jones, F. O. "Influence of Chemical Composition of Water on Blocking of Clay Permeability." Journal Petroleum Technology. Vol. 16, No. 4. 1964. pp. 441-446.
- Krynine, P. D. "The Mineralogy of Water Flooding." Producers Monthly. Vol. 3, No. 2. 1938. pp. 10-13.

- Land, C. S., and Baptist, O. C. "Effect of Hydration of Montmorillonite on the Permeability to Gas of Water Sensitive Reservoir Rocks." Journal of Petroleum Technology. Vol. 17, No. 10. 1965. pp. 1213-1218.
- Langelier, W. F. "The Analytical Control of Anti-Corrosion Water Treatment." Journal American Water Works Association. Vol. 28. 1936. p. 1500.
- Lansing, A. C., and Hewett, P. S. "Disposal of Phenolic Waste to Underground Formations." in Ninth Indus. Waste Conf. Proc. Purdue University. Eng. Ext. Ser. 87. 1955. pp. 184-194.
- Larson, T. E., and Buswell, A. M. "Calcium Carbonate Saturation Index and Alkalinity Interpretations." Journal American Water Works Assoc. Vol. 34. 1942. pp. 1667.
- Lewelling, H., and Kaplan, M. "What to do About Salt Water." Petroleum Eng. Vol. 31, July, No. 7. 1959. pp. B19-B24.
- Library of Congress. A Directory of Information Resources in the United States -- General Toxicology. Library of Congress, Washington, D. C. 1969.
- MacLeod, I. C. "Disposal of Spent Caustic and Phenolic Water in Deep Wells." Eighth Ontario Indus. Waste Conf. Proc. Ontario Water Resources Comm. Water and Pollution Advisory Committee. 1961. pp. 49-58.
- McKee, J. E., and Wolf, H. W. Water Quality Criteria. 2nd edition. The Resources Agency of California, State Water Quality Control Board. Publication No. 3-A. 1963.
- Mungan, N. "Permeability Reduction Through Changes in pH and Salinity." Journal Petroleum Technology. Vol. 17, No. 12. 1965. pp. 1449-1453.
- Murata, K. J. "Internal Structure of Silicate Minerals that Gelatinize with Acid." Am. Mineralogist. Vol. 28. 1943. pp. 545-562.
- National Academy of Sciences. Water Quality Criteria 1972. A Report of the Committee on Water Quality Criteria, Environmental Studies Board. National Academy of Sciences - National Academy of Engineering. U. S. Government Printing Office, Washington, D. C. 1974.
- Nutting, P. G. The Action of Some Aqueous Solutions on Clays of the Montmorillonite Group. U. S. Geological Survey Prof. Paper 197-F. 1943. pp. 219-235.
- Ohio River Valley Water Sanitation Commission. Evaluation of the Basal Sandstone for Wastewater Injection Ohio Valley Region. Cincinnati, Ohio. 1976.
- Ostraff, A. G. Introduction to Oil Field Water Technology. Prentice-Hall, Inc., Englewood Cliffs, N. J. 1968.

- Piper, A. M. Disposal of Liquid Wastes by Injection Underground - Neither Myth Nor Millenium. U. S. Geological Survey Circular 631. 1970.
- Roedder, E. Problems in the Disposal of Acid Aluminum Nitrate High-Level Radioactive Waste Solutions by Injection into Deep-Lying Permeable Formations. U. S. Geol. Survey Bull. 1088. 1959. 65 pp.
- Ryznar, J. W. "A New Index for Determining Amount of Calcium Carbonate Scale Formed by Water." Journal American Water Works Assoc. Vol. 36. 1944. p. 472.
- Sadow, R. D. "Pretreatment of Industrial Wastes for Subsurface Injection." in Underground Waste Management and Environment Implications. Amer. Assoc. of Petroleum Geologists Memoir 18. T. D. Cook, ed. Amer. Assoc. of Petroleum Geologists, Tulsa, Oklahoma. 1972. pp. 93-101.
- Selm, R. P., and Hulse, B. T. "Deep Well Disposal of Industrial Wastes." Chem. Engr. Prog. Vol. 56, No. 5. 1960. pp. 138, 140, 142, 144.
- Sharpley, J. F. "Microbiological Corrosion in Waterfloods." Corrosion. Vol. 17. 1961.
- Stiff, H. A., and Davis, L. E. "A Method for Predicting the Tendency of Oil Field Waters to Deposit Calcium Carbonate." Am. Inst. Mining Metall. Engineers Trans., Petroleum Div. Vol. 195. 1952. pp. 213-216.
- Trevorrow, L. E., Warner, D. C., and Steindler, M. J. Considerations Affecting Deep-Well Disposal of Tritium-Bearing Low-Level Aqueous Waste from Nuclear Fuel Reprocessing Plants. ANL-76-76, Argonne National Laboratory, Argonne, Illinois. March, 1977. 190 pp.
- Uhlig, H. H. Corrosion and Corrosion Control. Wiley and Sons, New York, New York. 1963.
- U. S. Atomic Energy Commission. Radioactive Wastes. U. S. Atomic Energy Commission, Division of Technical Information, Oak Ridge, Tennessee. 1969.
- U. S. Environmental Protection Agency. Quality Criteria for Water. U. S. EPA-440/9-76-023. Washington, D. C. 1976. p. 501.
- U. S. Environmental Protection Agency. Compilation of Industrial and Municipal Injection Wells in the United States. Environmental Protection Agency Publication EPA-520/9-74-020. 2 Vols. 1974.
- U. S. Environmental Protection Agency. Methods for Chemical Analysis of Water and Wastes - 1971. U. S. Environmental Protection Agency. Water Quality Office, Cincinnati, Ohio. 1971. 312 pp.

- Van Everdingen, R. O., and Freeze, R. A. Subsurface Disposal of Waste in Canada. Technical Bulletin No. 49. Inland Waters Branch, Department of the Environment, Ottawa, Canada. 1971.
- Van Olphen, H. Clay Colloid Chemistry. Interscience Publishers, New York, New York. 1963. 301 pp.
- Warner, D. L. Deep Well Injection of Liquid Waste. U. S. Dept. of Health, Education, and Welfare. Public Health Service. Environmental Health Series Publication No. 999-WP-21. 1965. 55 pp.
- Warner, D. L., Survey of Industrial Waste Injection Wells. 3 Vols. Final Report, U. S. Geological Survey Contract No. 14-08-0001-12280. University of Missouri, Rolla, MO 1972.
- Warner D. L., and Orcutt, D. H. "Industrial Wastewater-Injection Wells in the United States - Status of Use and Regulations, 1973." in Underground Waste Management and Artificial Recharge. Jules Braunstein, ed. Amer. Assoc. of Petroleum Geologists, Tulsa, Oklahoma. 1973. pp. 687-697.
- Wright, C. C. Deep Well Disposal of Wastes - The Role of Water Treatment and Surveillance. undated.
- Yuster, S. T. "The Gypsum Problem in Water Flooding." Producers Monthly. Vol. 3, No. 6. 1939. pp. 27-35.

## CHAPTER 6

### PRE-INJECTION WASTEWATER TREATMENT AND SURFACE FACILITY DESIGN

To ensure success of a subsurface waste-disposal operation, surface pre-injection treatment of the wastewater is generally required. Treatment can be quite expensive, but it can make the difference between a successful, environmentally-cognizant operation and one subject to repeated difficulties and even failure. The principal objective of pre-injection treatment is to modify the physical and chemical character of a waste so that it is compatible with the surface and subsurface equipment that is used and with the injection interval and its contained water. Details of the problems that can occur when incompatibility exists were discussed in Chapter 5. Table 6-1 is a brief summary of such problems along with suggested means for evaluating and controlling them.

As suggested in Table 6-1, pretreatment processes are not the only means of solving some of the problems related to wastewater character. For example, corrosion control can be achieved by use of corrosion-resistant materials and a buffer zone can be established to prevent reaction between injected fluids and aquifer water. The choice of control method will be dictated by economics, engineering feasibility and regulatory controls.

The first step in development of a pre-injection treatment scheme is characterization of the wastewater in terms of source, volume, and physical, chemical, and biological characteristics as discussed in Chapter 5. Then, if the waste is classified as suitable for injection, the necessary treatment processes can be selected.

#### PLANT PROCESS CONTROL

An extremely important and often overlooked means of increasing the feasibility of wastewater injection is modification of waste volume and/or chemistry by control of the process by which the wastewater is produced.

In many industrial plants, particularly older ones, analysis of the plant processes will show that changes can be made to reduce the quantity of waste that is intended for injection. Perhaps the most easily made change is segregation of wastes so that dilute streams of washwater, etc., are not included in the injection stream. Major process changes may be possible for the sole purpose of reducing waste volumes so as to match plant discharge to available well receptivity. Also, the chemistry of a wastewater can sometimes be changed resulting in increased waste injectability. Such possibil-



TABLE 6-1. OPERATIONAL PROBLEMS RELATED TO WASTEWATER CHARACTER (OHIO RIVER VALLEY WATER SANITATION COMMISSION, 1969)

PROBLEM OF CONCERN	MEANS OF EVALUATING	MEANS OF CONTROLLING UNDESIRABLE EFFECTS
<b>REACTION</b>		
Wastes and formation minerals	Laboratory tests and observation of system	Pre-injection waste treatment
Wastes and formation water	Laboratory tests	Pre-injection waste treatment or a buffer zone
Autoreaction of waste at formation temperature and pressure	Laboratory tests	Pre-injection waste treatment
Wastes and system components	Laboratory tests and observation of system	Pre-injection waste treatment, addition of corrosion inhibitors to waste, and use of corrosion-resistant materials
<b>MICROORGANISMS</b>	Laboratory tests and observation of system	Pre-injection waste treatment and addition of biocide
<b>SUSPENDED SOLIDS AND OILS</b>	Laboratory tests and observation of system	Pre-injection waste treatment or formation treatment
<b>ENTRAINED OR DISSOLVED GASES</b>	Laboratory tests and observation	Chemical or mechanical degasification

ities should not be overlooked in the design of a new plant, because it may be feasible to selectively segregate a wastewater for injection that cannot be handled by other means and which would interfere with the treatment of other plant wastes. Such planning optimizes the injection process.

## TREATMENT PROCESSES

The types of pre-injection treatment used to achieve the desired goals of a smooth, continuous, trouble-free operation are as varied as the geologic conditions and wastewater properties that are encountered. The more important basic pretreatment operations are listed in Table 6-2. The nature of each type of operation will be examined in some detail. The complexity of pre-injection treatment ranges from systems where only wastewater storage is required before injection, as shown in Figure 6-1, to ones where an extensive series of steps is required, as shown in Figure 6-2. The basic pretreatment steps listed in Table 6-2 are not all necessarily used nor do they always occur in the sequence given. For example, in Figure 6-2 addition of corrosion inhibitors and storage are provided at both ends of the treatment sequence.

In addition to the basic pretreatment steps listed in Table 6-2, unusual steps may be desirable in special instances such as distillation for recovery of valuable volatile chemicals, biological treatment to break down certain organic chemicals, or evaporation to reduce injection volumes.

### Storage and Equalization

Wastewater streams may be produced in batches or they may be continuously produced. When waste is intermittently produced in batches, storage is provided to allow pre-treatment and injection at the desired rate and to equalize the chemical and physical properties of the wastewater. When wastes are produced continuously, storage and equalization are beneficial in overcoming extreme fluctuations in flow rate and wastewater chemistry. Detention and mixing of several wastewater streams can result in chemical modifications such as neutralization. Nemerow (1971) cites an example where a large chemical corporation producing an acid waste provides storage for its waste for a 24-hour period after which another nearby plant pumps its alkaline waste into the holding basin, thereby neutralizing both wastes. Storage basins can be used for settling of the largest suspended solids, if this is desired. On the other hand, mechanical agitation can be used where settling of solids is not desired.

As is shown in Figure 6-1, in the most simple systems, if the waste is low in suspended solids and is non-corrosive, the collecting tank, transfer pipes, injection pump, and controls may be the only required surface equipment. This may also be the case where injection is into cavernous formations that will accept untreated wastewater without danger of plugging. There are even systems in which the injection pump is not needed, because wastewater can be injected by gravity. Donaldson (1972) states that there are a few such installations, but that they are not typical and additional equipment is usually necessary.

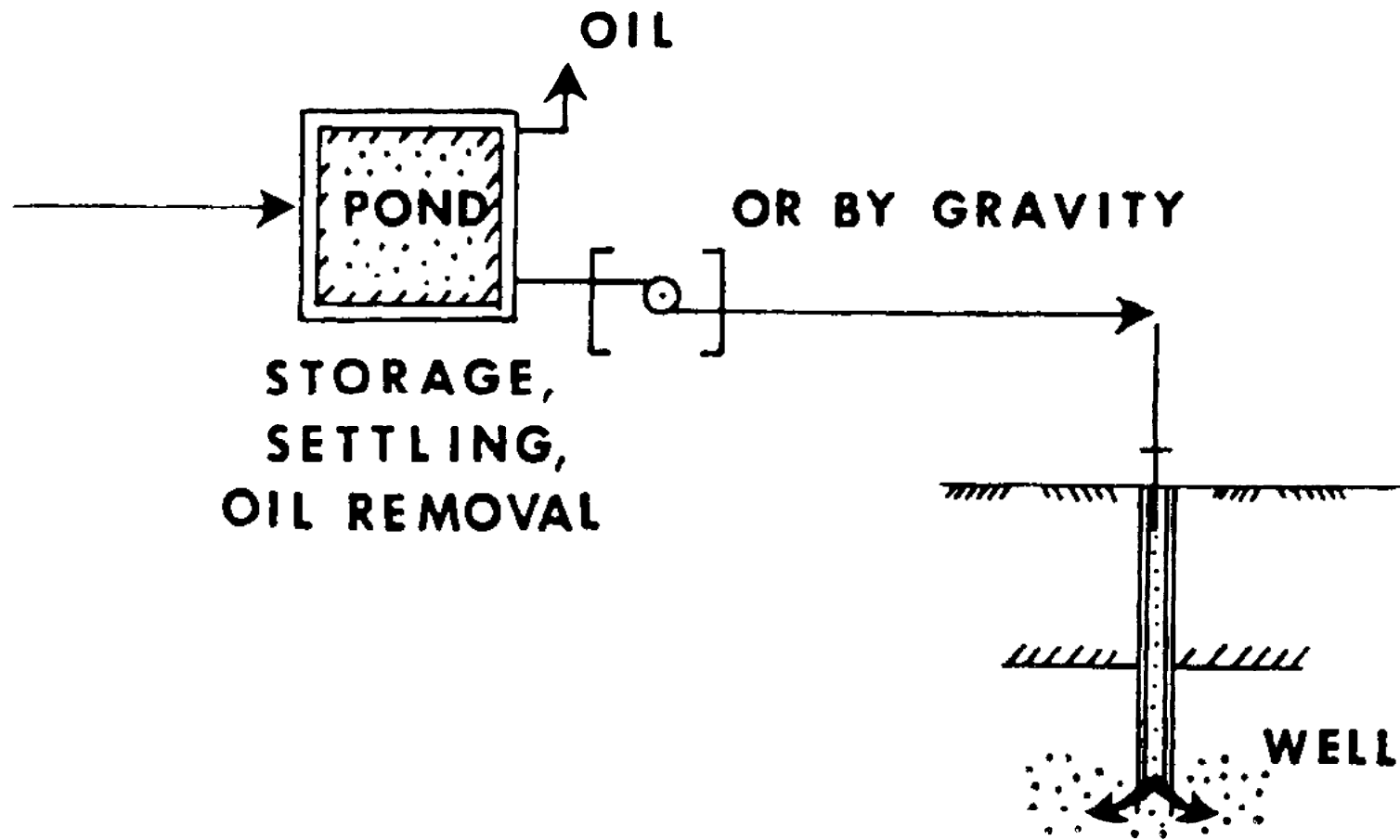
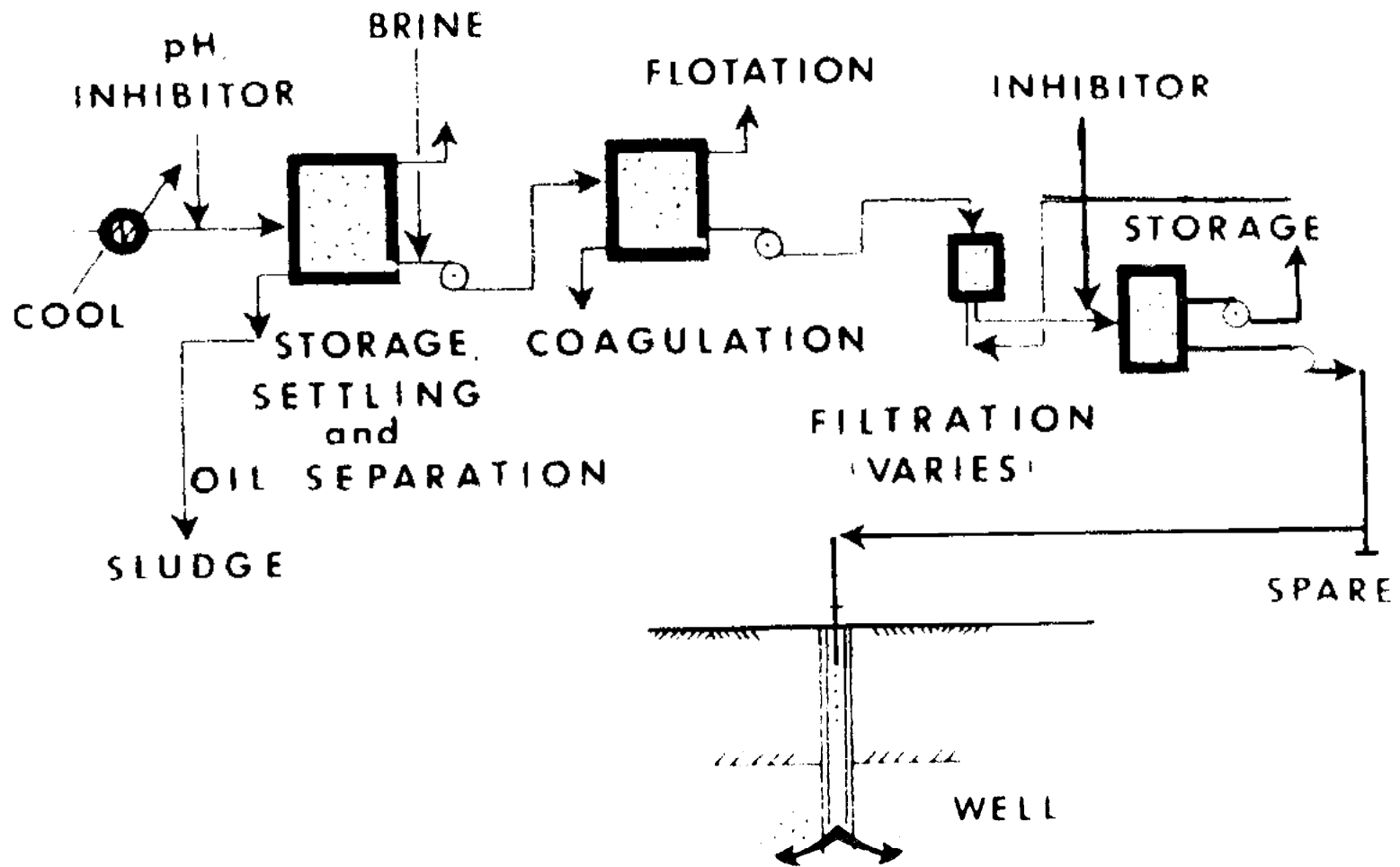

FIGURE 6-1. SURFACE DESIGN FOR PRETREATMENT OF WASTES WHERE ONLY STORAGE IS REQUIRED (SADOW, 1972).



192

FIGURE 6-2. SURFACE DESIGN FOR PRETREATMENT OF WASTES WHERE EXTENSIVE TREATMENT CLEANUP IS REQUIRED (SADOW, 1972).

TABLE 6-2. BASIC PRETREATMENT STEPS AND THEIR OBJECTIVES

- 
1. Storage and equalization - to allow an even flow of wastewater to treatment facilities and/or injection pumps and to permit equalization of wastewater properties.
  2. Oil separation - to remove liquid oils.
  3. Suspended solids removal - to remove particulate matter.
  4. Chemical and biological treatment - to modify wastewater chemistry and achieve compatibility of wastewater with the injection system and injection interval.
  5. Corrosion and bacterial control - to reduce corrosiveness and inhibit growth of microorganisms.
  6. Degasification - to remove undesirable entrained or dissolved gases.

The design of a storage tank or basin is not complex, but it is so dependent on the individual circumstances that general specifications cannot be given. The following are some design guidelines suggested by Nemerow (1971). The size and shape of tanks or basins vary with the quantity of wastewater and the pattern of its discharge. When equalization is desired, capacity should be adequate to hold, and render homogeneous, all the waste streams that are to be equalized. If a cycle of plant operations is two hours, then a tank that can hold a two-hour flow will usually be sufficient. If a cycle is repeated only each 24 hours, then storage for at least a 24-hour flow will be required. It may be desired to hold and equalize several cycles of flow. In any case, the holding capacity is related to the volume of wastewater produced and the length of plant cycle.

The mere holding of waste, however, is not sufficient to equalize it. Each unit volume of waste discharged must be adequately mixed with other unit volumes of waste discharged many hours previously. This mixing may be brought about in the following ways:

- (1) proper distribution and baffling;
- (2) mechanical agitation;
- (3) aeration; and
- (4) combinations of all three

These possibilities are expanded upon by Nemerow (op. cit.).

### Oil Separation

The presence of oil in a wastewater is undesirable because it can cause permeability reduction in sands or sandstones. Also, the presence of even minute quantities of oil causes fouling of surface and subsurface equipment, particularly filters. There are four common mechanical methods for oil removal. These are: gravity separation, flotation, coagulation and sedimentation, and filtration.

#### Gravity Separation --

In gravity separation, the oil and water mixture is allowed to separate into two phases, with the lighter oil phase rising to the surface of the heavier water phase. Gravity separation of oil can be achieved in open basins or tanks with an appropriate means of skimming off the oil or specially designed oil-water separators can be used. The design of oil-water separators is covered in detail by the American Petroleum Institute (1969). Figure 6-3 shows one example of an API oil-water separator.

Gravity separation is highly effective with low specific gravity oils that are not emulsified, but is less effective or impossible with high specific gravity oils and with emulsions. The probability of success of gravity separation can be judged by a test described in API Method 734: Determination of Susceptibility to Oil Separation (American Petroleum Institute,

DESIGNED FOR INSURING  
 RUBBER BALLS/OIL STOPPERS  
 FOR CONVERTING FLOWS  
 TO CLEANING SEPARATOR  
 TO OILS  
 WATER, OR GAS  
 BALLS MAY BE INSTALLED  
 IF DESIRED



PLAN

WAVE FLIGHT  
 SKIMMER

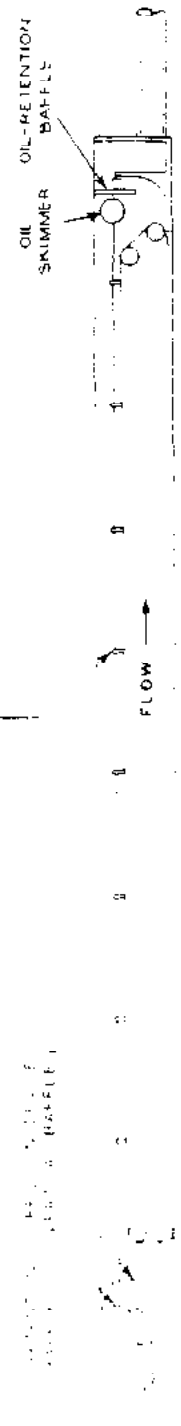

SECTION A-A

FIGURE 6-3. AN EXAMPLE OF ONE TYPE OF API OIL-WATER SEPARATOR (AMERICAN PETROLEUM INSTITUTE, 1969, P. 6-5).

1953). The commonly cited disadvantages of gravity separation are discussed by Ingersoll (1951) and by the American Petroleum Institute (1951 and 1969).

Removal of small amounts of oil that remain after gravity separation or that may be initially present in some wastewaters can be accomplished by flotation, coagulation and sedimentation, or filtration (American Petroleum Institute, 1969).

#### Flotation --

Pressure flotation is a process in which the wastewater is saturated with air under pressure and then passed into a flotation chamber at atmospheric pressure. Under reduced pressure, the air is released from solution as small bubbles that carry the oil globules to the surface, where they are skimmed off. Figure 6-4 is a schematic diagram of an air-flotation oil removal process. Gases other than air may be used to avoid saturating the wastewater with corrosive oxygen. Another form of flotation is vacuum flotation in which air is introduced by mechanical agitation or air injection and a vacuum is then applied to produce bubbles and cause flotation. Flotation is effective for wastewaters containing less than 100 parts per million of oil and where emulsions do not exist (Wright and Davies, 1966).

Wright and Davies (1966) list some disadvantages of flotation for oil removal as:

1. Emulsions are seldom resolved
2. Suspended solids may interfere with oil removal
3. The process is very sensitive to process variables such as:
  - a. The flow volume through the system
  - b. The gas/wastewater ratio

#### Emulsions and Other Methods for Removing Oils --

Because, as has been pointed out above, emulsions seriously interfere with oil removal, the properties of emulsions and methods of dealing with them will be briefly explored. An emulsion can be found when oil and water are mixed together under agitated conditions. The emulsion is, in fact, the dispersion of finely divided droplets of one liquid into another liquid medium. Depending on the relative quantity of the two liquids, either oil-in-water or water-in-oil emulsion can be found. To make the emulsion stable, a third substance, called an emulsifying agent, is required. Common emulsifying agents include soaps, sulfated oils and alcohols, sulfonated aliphatics and aromatics, quaternary ammonium compounds, non-ionic organic ethers and esters, and various solids. Emulsifying agents enhance the strength of the interfacial film around the droplets of the dispersed liquid by providing layers of electrical charges, thus increasing the stability of emulsions. Stability is created because the finely divided droplets are prevented from coalescing into large droplets.



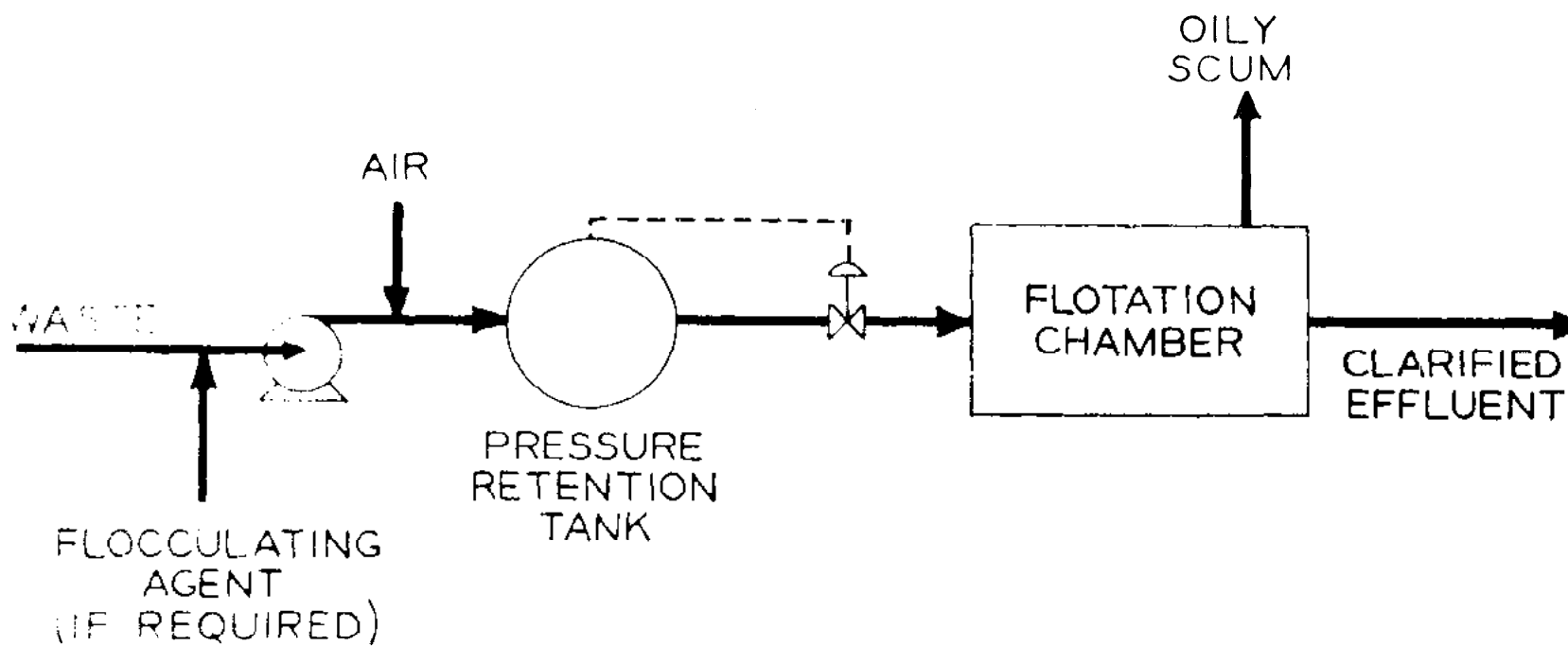

FIGURE 6-4. SCHEMATIC DIAGRAM OF A FULL-FLOW AIR-FLOTATION OIL REMOVAL PROCESS (AMERICAN PETROLEUM INSTITUTE, 1969, P. 9-10).

Emulsions can be broken by several different methods. Heat is helpful in nearly all emulsion-breaking operations. Heating water-in-oil emulsions lowers the viscosity of the oil and promotes settling of free water. Heating also increases the vapor pressure of the water and tends to break the films around the globule. Separation of the oil and water phases may be facilitated by using caustic soda to adjust the pH between 9 and 9.5. Distillation is an effective method of breaking emulsions and offers the advantage of separating the water and light oil from the emulsifying agent which remains in the residue.

Emulsions can be broken by chemical methods which vary according to the properties of the emulsions. Perhaps the most widely used chemical method is flocculation or coagulation. The two terms are frequently used interchangeably to describe the treatment process in which chemicals and other additives are used to produce finely divided precipitates or microflocs. These small particles then agglomerate into larger clumps that are more readily removed. A wide variety of coagulants and coagulant aids are used. The more common ones are listed by the American Petroleum Institute (Table 6-3A) along with a jar test used for their selection and dosage determination (American Petroleum Institute, 1969, p. 9-18).

According to the American Petroleum Institute (1969), dissolved-air flotation in combination with coagulation can reduce oil content to levels approaching oil solubility. Further details of oil removal by this process are given by the API (1969).

After coagulation, oil can alternatively be removed by sedimentation, if the flocs are dense enough to settle. However, oils will usually float as opposed to suspended solids, which will usually sink. Sedimentation and the fourth oil removal process, filtration, are discussed in the next section concerning solids removal.

### Suspended Solids Removal

Processes for suspended solids removal include sedimentation, flotation, and/or filtration, and these processes in combination with coagulation.

#### Sedimentation --

Sedimentation is the process of removal of solids from water by gravity settling. It is used when large amounts of suspended solids are present in order to reduce the load on filters or, in cases where cavernous or fracture porosity is present, sedimentation alone may be sufficient. Sedimentation may be accomplished in basins or tanks. Basins can range in sophistication from unlined earthen ponds to lined concrete basins. According to Nemorow (1971), in recent years, design engineers have been using either circular or square tanks instead of more conventional rectangular basins, for reasons of space and/or economics. Most tanks are of standard commercial design and an appropriate one can be selected by consultation with representatives of companies that supply pollution control and water treatment systems. If a special design or construction material is required, this can be arranged for also. Sedimentation basins are tailored for each specific site and waste-

water problem, but are often designed on the basis of existing installations handling the same or a similar wastewater. Design of sedimentation basins is covered in textbooks on industrial waste treatment and water treatment (American Water Works Assoc., 1971; Nemorow, 1971; Ross, 1968; Ostroff, 1965; Eckenfelder, 1966; Gurnham, 1955). When both solids and oils are present, the solids will usually sink and the oils float. Thus, both can be removed in a sedimentation basin or tank which is designed for withdrawal of sludge from the bottom and skimming of scum from the top (Figure 6-5). If possible, however, it may be preferable to prevent mixing of waste streams containing oil with ones containing suspended solids because removal of oil and solids separately may be more readily accomplished. Dilution and formation of emulsions is also avoided (Gurnham, 1955).

#### Flotation --

Flotation, which was discussed under oil removal, is also used for solids removal. Application is most likely to wastewaters containing small difficult-to-settle particles or to oily wastes. Flotation is also possible as an addition to sedimentation, rather than an alternative.

#### Filtration --

Filtration is the mechanical separation of suspended solids (or oils) from wastewater by passing it through a porous medium that retains the solids (or oils) on its upstream face or in the body of the filter. The wastewater is forced through the filter by gravity, fluid pressure, or a vacuum. Operation of a filter at a constant flow rate requires continually increasing pressure or fluid head to maintain the rate. When the maximum allowable operating pressure is reached, filters are backwashed or otherwise cleaned to renew them. Filters can also be operated at constant pressure, in which case the flow rate will decline with time until maintenance is required.

The porous body which retains the suspended solids is the filter medium. Common filter media include beds of granular particles such as sand or anthracite coal, and cloth, plastic, or metallic screens. Screens may be coated with filter aids to improve their performance. Diatomaceous earth is the most commonly used filter aid. The filter aid increases the efficiency of solids removal and is replaced when it becomes clogged. Other less common filter media are straw, hemp, glass cloth, paper, wool, and rubber (Ostroff, 1965). Straw is mentioned in many references as being effective in filtering oil that is not removed by separation.

Slow Sand Filters--Filters comprised of beds of granular particles are often classified as slow or rapid sand filters. As the name implies, the velocity of flow through slow sand filters is very low ( $\approx 0.2$  gpm/ft<sup>2</sup>). To compensate for this, the filter area must be large. Water is passed by gravity downward through 12 to 18 inches of graded sand deposited on a base of graded gravel. Filtered water is removed by underdrains. Because of their inflexibility and the large area required, these filters are not popular for pre-injection treatment systems and will not be discussed further.

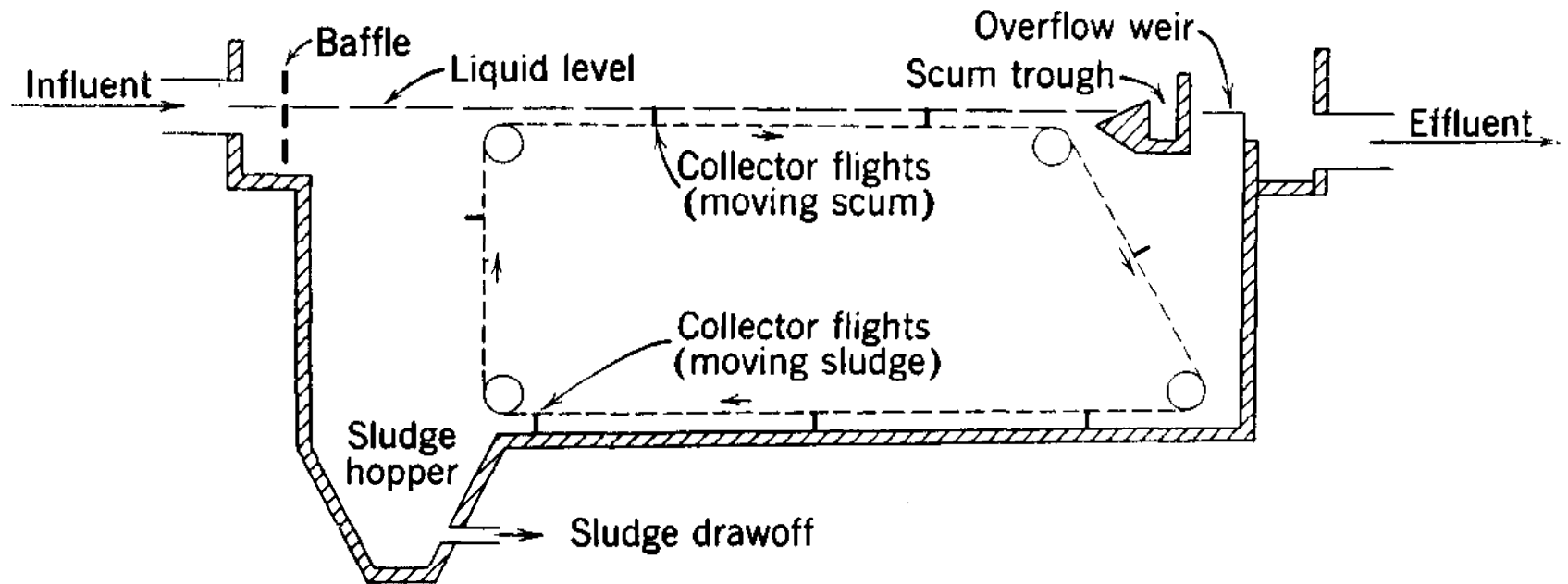

FIGURE 6-5. SCHEMATIC DIAGRAM OF A SEDIMENTATION TANK EQUIPPED FOR REMOVAL OF BOTH SLUDGE AND SCUM (GURNHAM, 1955, P. 137).

Rapid Sand Filters--Rapid sand filters are subdivided into gravity rapid sand filters and pressure sand filters. Gravity rapid sand filters are similar to the slow sand filters described above. They are composed of a bed several feet thick that is generally deposited as several layers of varying grain sizes, with fine sand at the top and gravel at the base. Anthracite coal of varying particle size is also used as a filter medium. Typical specifications for the media of a gravity rapid sand filter are given in Table 6-3, and a cross-sectional diagram is shown in Figure 6-6.

The rate of flow through a gravity rapid sand filter depends on the size, grading, and depth of sand, type and efficiency of pre-filtration treatment, and the required quality of effluent. A typical rate is 2 gal/min per square foot of filter area, but higher rates are possible. The two general schemes for control of filter operation are rate-of-flow control and loss-of-head control. Since it will normally be desired to maintain a constant rate of filtration, the rate-of-flow control system is most widely employed. In this system, each filter is provided with controls that maintains a constant flow rate through the filter. As time passes, the hydraulic head required to maintain a constant flow rate increases, because the filter becomes clogged with the solids removed from the treated water. When the head required reaches a predetermined maximum level, the filter is taken out of use and cleaned. Cleaning is accomplished by backwashing and, in some cases, surface washing. After cleaning, filter effluent is generally recycled for a few minutes to allow the bed to settle and filtrate quality to stabilize.

Rapid sand filters can be equipped for manual operation, push button operation, or fully automatic operation. In automatic operation, cleaning of the filter (backwashing and surface washing, if used), recycling, and return to service are automatically carried out, when needed.

According to Ostroff (1965), pressure sand filters are more widely used in industrial applications and in the oil fields than are any other types of filters. Pressure sand filters are based on the same principles as the gravity-feed rapid sand filter, except that the filter media and under-drain system are placed in a cylindrical tank, and the water is passed through the filter under pressure. This has the advantage that the filtered water can be moved without additional pumping.

The position of the pressure filter tank may be either vertical or horizontal. For areas up to 80 sq. ft. of filtering surface, the filters are usually the vertical type; for larger areas, the horizontal type. Typical vertical and horizontal pressure sand filters are shown in figures 6-7a and 6-7b. The horizontal type is generally about 8 ft. in diameter and ranges in length from 10 to 25 ft. Vertical units range from 1 to 10 ft. in diameter. Filter media for use in pressure sand filters are similar to those shown in Table 6-3 for gravity rapid sand filters.

The rates of flow through pressure sand filters are generally 1 to 2 gpm/sq. ft. of filter area, and filter capacities are up to about 1,000 gpm for the largest horizontal filters. The operation of pressure filters is controlled

TABLE 6-3. TYPICAL SPECIFICATIONS FOR FILTER MEDIA  
USED IN A GRAVITY-FEED RAPID SAND FILTER  
(THE PERMUTIT COMPANY, 1954).

48" Sand & Gravel	48" Anthracite
<p>5" of 1 1/2" x 1" gravel            5" of 1" x 1/2" gravel            4" of 1/2" x 1/4" gravel            4" of 3/8" x 3/32" gravel            6" of coarse sand, 0.8 to 1.2 mm effective size            24" of fine sand, 0.4 to 0.5 mm effective size</p>	<p>5" of No. 6 size 1 5/8" x 13/16"            5" of No. 5 size 13/16" x 9/16"            4" of No. 4 size 9/16" x 5/16"            4" of No. 3 size 5/16" x 3/16"            6" of No. 2 size 3/16" x 3/32"            24" of No. 1 size 0.55 to 0.65 mm effective size</p>
<p>The uniformity coefficient of the sand shall not exceed 1.6. The sand must be round or angular, graded dry, and be practically pure silica, free from appreciable quantities of foreign material. The gravel shall consist of hard rounded pebbles, containing not more than 2% by weight of thin, flat, or elongated pieces, determined by hand-picking, and free of shale, sand, clay, loam, or organic impurities.</p>	<p>The uniformity coefficient of the No. 1 anthracite shall not exceed 1.6. The anthracite shall consist of hard and durable grains, having a hardness of from 3 to 3.75 on the Moh scale; specific gravity approximately 1.57; shall be free from iron sulfides, clay, shale, or extraneous dirt; and not more than 1% shall consist of dust.</p>

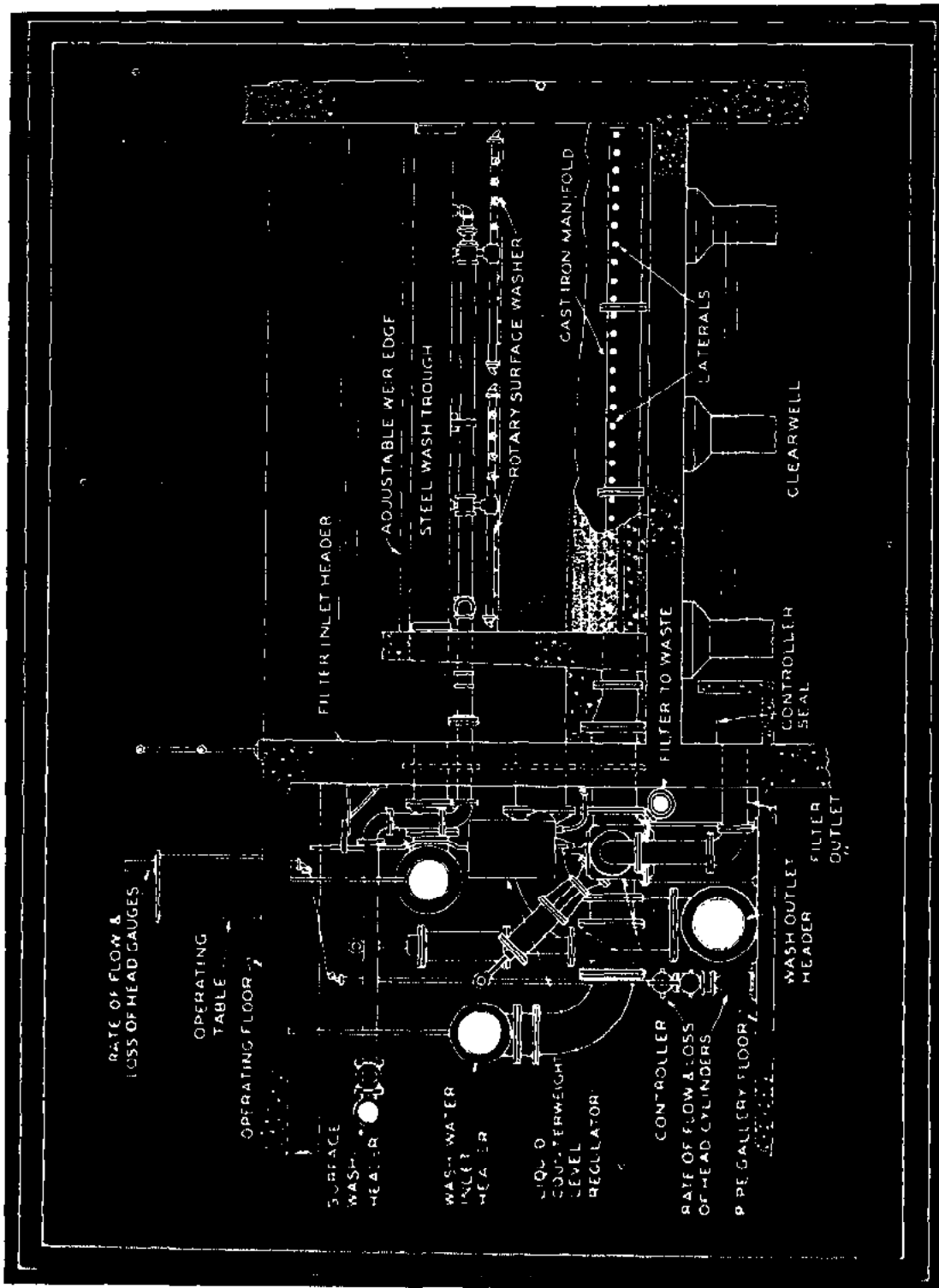

FIGURE 6-6. CROSS SECTION OF A CONCRETE GRAVITY RAPID SAND FILTER (THE PERMUTIT COMPANY, 1954).

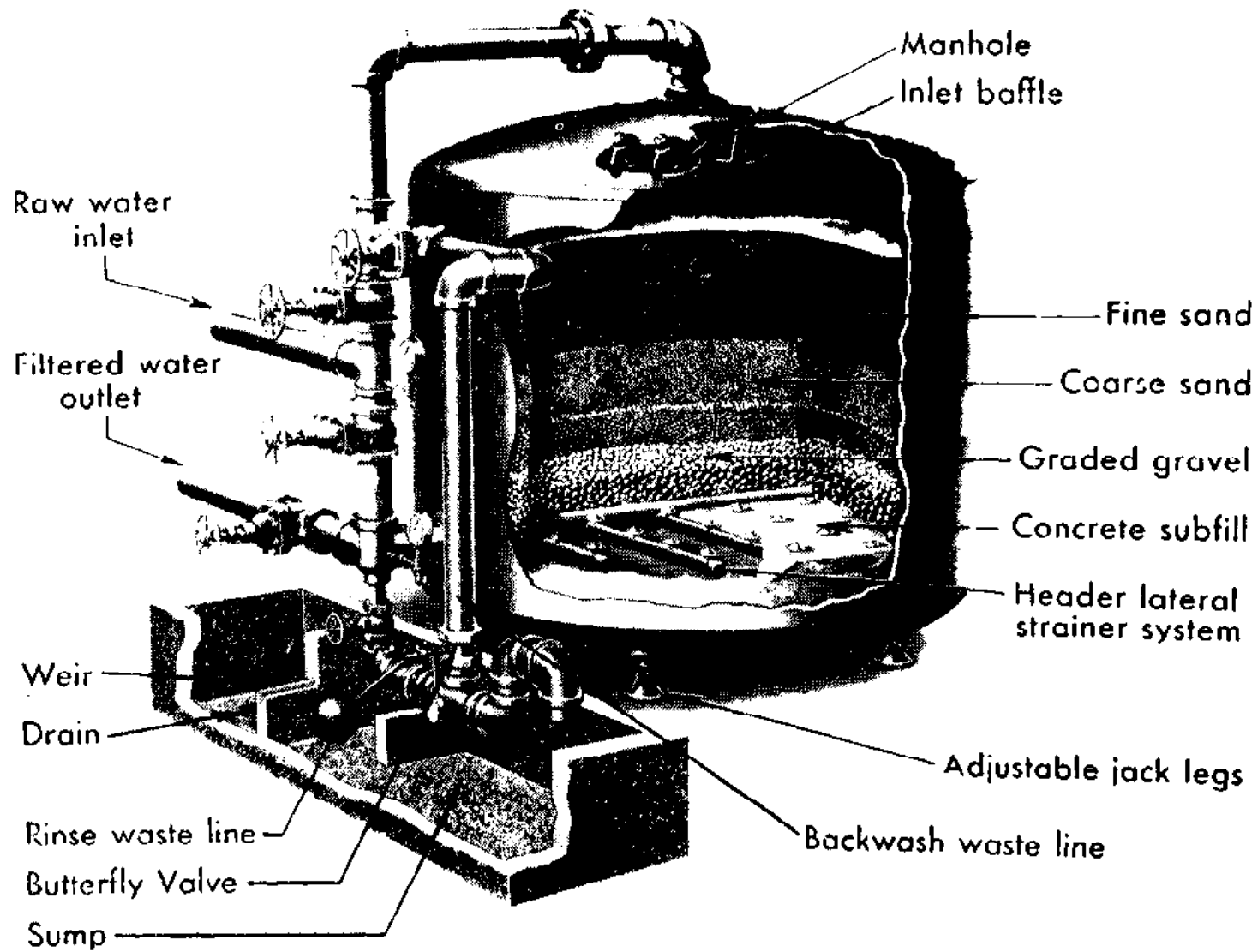

FIGURE 6-7 (a). TYPICAL VERTICAL PRESSURE SAND FILTERS  
(THE PERMUTIT CO., 1954).



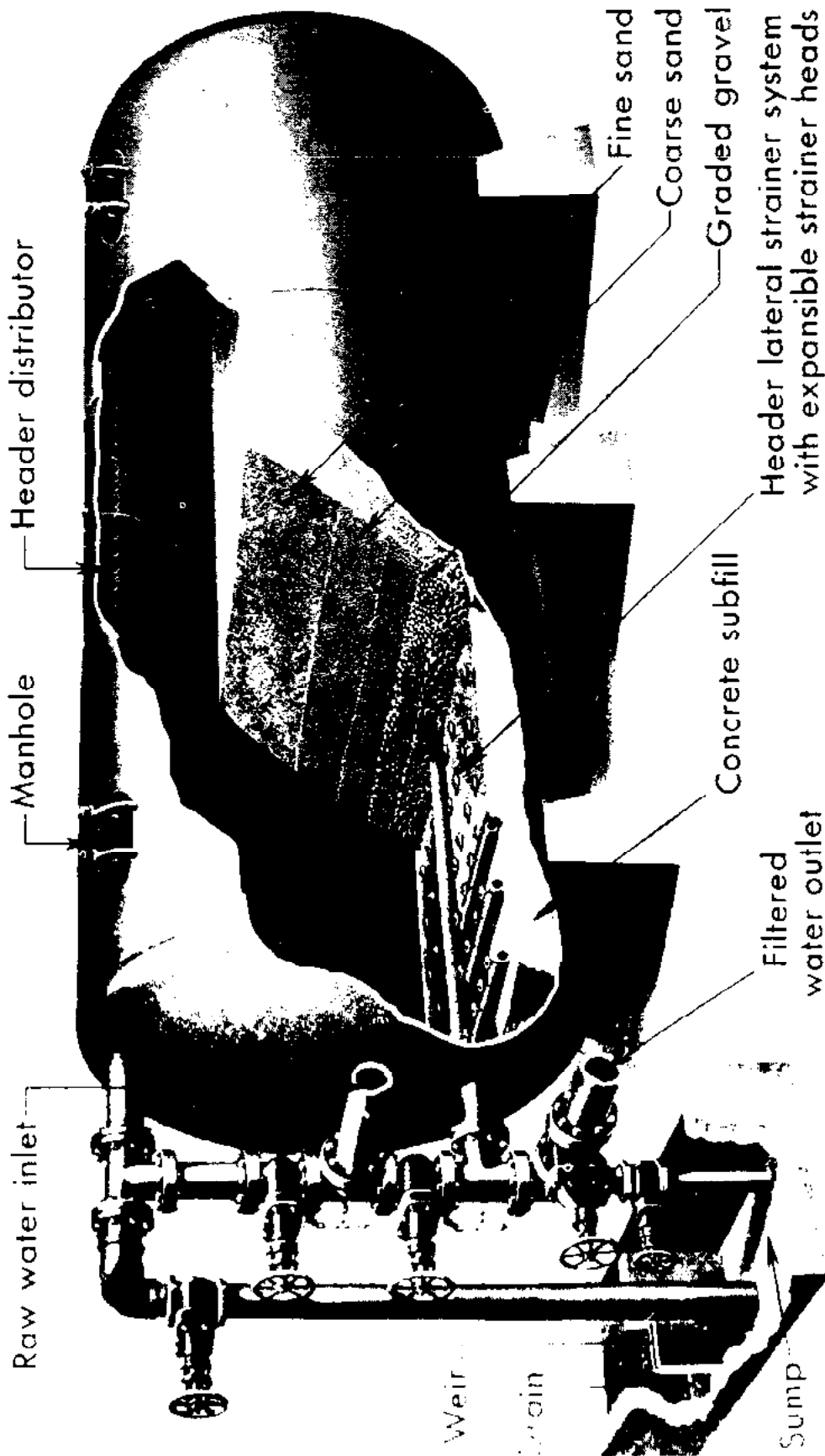

FIGURE 6-7 (b). TYPICAL HORIZONTAL PRESSURE SAND FILTERS (THE PERMUTIT CO., 1954).

Pressure filters offer some advantages over gravity filters. Since they have a higher capacity, pressure filters require less area. Pressure filters also have an advantage where only one pumping of the water is desired. One disadvantage is that the sand bed is not visible, so that the operator cannot observe its condition and see if the backwash is functioning properly. It is also more difficult to clean and replace the filter media or to observe the filtered water.

Diatomite Filters--Of the remaining types of filters, diatomite or diatomaceous earth filters are the most widely mentioned for water and wastewater filtration. The filter is a porous screen, cloth, or other porous septum upon which a thin layer of the diatomaceous earth or diatomaceous earth-asbestos fiber medium is deposited prior to the beginning of filtration. This layer, generally about 1/8 inch thick, is called the precoat. It is applied by passing a slurry of diatomaceous earth and water through the filter until a sufficient coating has been deposited and the effluent is clear. After deposition of the precoat, filtration begins.

Diatomite filters are either pressure or vacuum type (Figure 6-8). According to Bauman (1971) the pressure filter theoretically is more useful than the vacuum filter, since it can be designed to operate at any terminal pressure drop. Practically, however, the pressure housing inherent to the system makes it difficult to observe the effectiveness of the various filter operations and increases the cost of maintenance in repairing or replacing filter elements. The vacuum filter, though limited to 20 to 24 ft. of terminal pressure drop across the filter, is much easier to operate and maintain. Vacuum filters will normally be used with clearer waters, and pressure filters with more turbid waters.

Normally, diatomaceous earth filtration requires continuous addition of filter aid into the waste stream by means of a slurry feeder following the precoat step. This "body feed" builds up on the filter throughout the period of filtration and maintains the porosity of the filter cake. The amount of diatomite added to the raw water varies with the nature and quantity of solids to be removed and with operating characteristics of the system. In some instances, where the suspended solids content is low, the body feed can be omitted. There are various grades of commercially available diatomite filter media, which range in particle size and permeability (Dillingham and Baumann, 1964). The grade selected would ideally be that which would have the maximum permeability and still provide the required degree of filtration.

When the differential pressure across the filter reaches the maximum allowable, filtering is stopped, and the filter cake is washed from the septum, then a new precoat layer is deposited and filtration resumed.

Diatomite filters, like rapid sand filters, have the advantages of high flow rates and low space requirements. In addition, they can deliver a very high quality water. Wright and Davies (1966) reported routinely obtaining a filtered water with 0.2 ppm suspended solids while using a diatomite filter. For this latter reason, diatomite filters have been frequently selected for pretreatment of wastewater before injection.

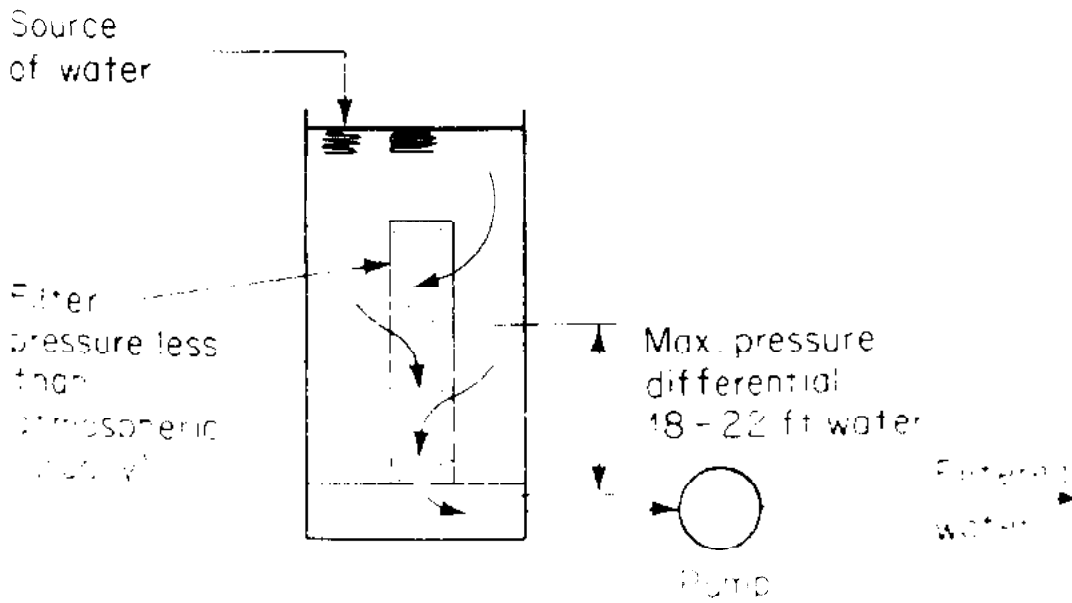
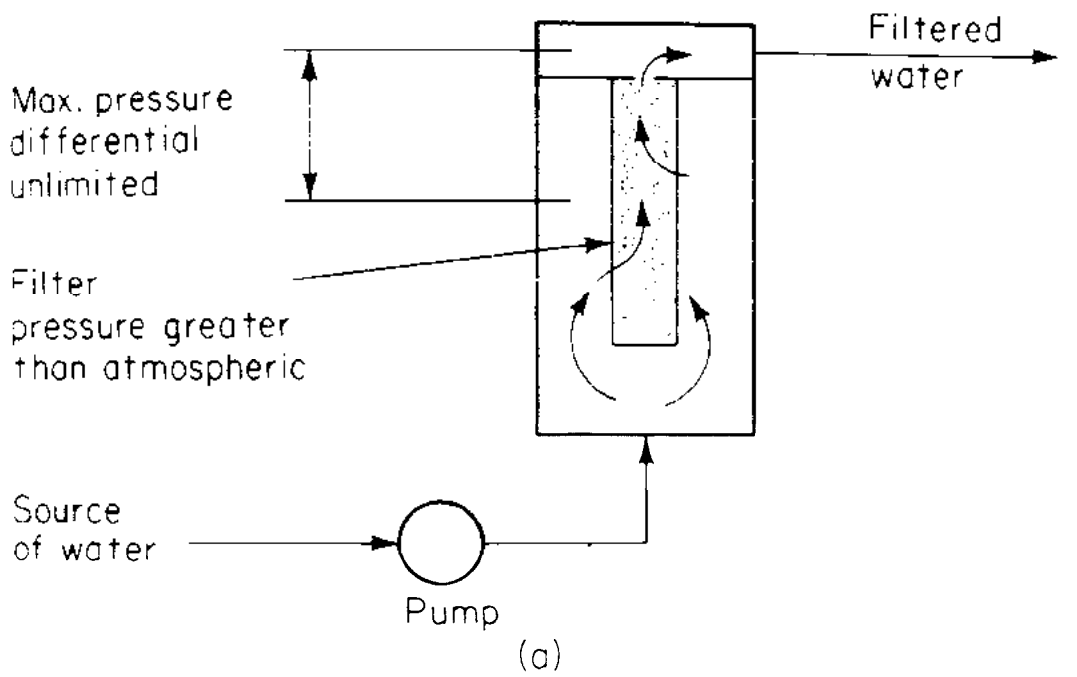

FIGURE 6-11. SCHEMATIC DIAGRAMS OF PRESSURE (a) AND VACUUM (b) FILTRATION METHODS (BAUMANN, 1971).

At the same time, diatomite filters pose a dangerous potential for plugging of injection wells when improperly operated. Wright and Davies (1966) listed some of the causes of filter failure and resulting well plugging as:

- a. Plant operator leaves open line to high pressure pumps when back washing and recoating filter. Large amounts of asbestos and diatomaceous earth are injected into the well.
- b. The filter cake and precoat drop off the screen in whole or in part, due to temporary shut down of filter or to a momentary pressure surge. Subsequent operation of filter results in all slurry feed and all suspended solids going through the filter into the high pressure pumps and/or into the wells.
- c. Inadequate precoating of the screens has left holes in the pre-coating, resulting in the same condition as Item "b" but to a lesser degree.
- d. Operator leaves backwash valve open partially or completely after backwashing filter, resulting in partial or complete bypassing of the filter. This is worse than no filter at all, as in addition to bypassing the filter, filter aid is supplied continuously to the water.

Filter Controls and Design--Because such incidents as mentioned above cannot be entirely precluded, safeguards should be installed to prevent accidental injection of solids or sludge. The pre-injection treatment system should be designed for automatic recycle of treated water or shutdown of the system in the event that an excess amount of suspended solids is present in the injection water. This can be done by passing the treated water through a continuous monitoring turbidimeter that is equipped with the desired controls. Baumann (1971) notes that there are a number of continuous-flow light-scattering microphotometers available, some of which are sensitive to 0.001 jackson units of turbidity ( $\approx$  0.001 mg/l suspended solids) and accurate to 0.005 jackson units. Another precaution that can be taken is the installation of a back-up filter, perhaps an in-line cartridge type filter, in the system as a final treatment device before injection. Such a filter is not intended to perform routine removal of suspended solids, but to insure that no excess solids reach the well. These two precautions should be considered for all systems in which filtration is an important step, not just those that use diatomite filters.

As with sedimentation tanks, many companies manufacture filters and filter controls and an appropriate filter system design can be obtained by consultation with representatives of such companies.

Coagulation --

A discussion of coagulation was presented in the section concerning oil removal, but some additional explanation is needed at this point. The purpose of coagulation in suspended solids removal is to promote the formation

of clumps or flocs of suspended solids by agglomeration of smaller particles. Coagulation is frequently needed before sedimentation and/or filtration to promote the effectiveness of these processes.

The most commonly used coagulants are compounds of iron or aluminum (Table 6-3A). According to Ostroff (1965), iron flocs are usually denser and more rapidly and completely precipitated than are aluminum flocs. However, aluminum compounds are better coagulants for waters containing appreciable organic material. Jar tests (Ostroff, 1965; American Petroleum Institute, 1969) are recommended for determination of the proper coagulant and the optimum concentration.

Coagulant aids must sometimes be added in addition to the coagulant to obtain the desired flocculation. A few coagulant aids are listed in Table 6-3A. Not listed in the table are polyelectrolytes or polymeric flocculents, which have become important in water and wastewater treatment (Cohen and Hannah, 1971; Nemerow, 1971; Ostroff, 1965). In addition to coagulants and coagulant aids, pH adjustment may assist the coagulation process. According to Cohen and Hannah (1971) iron and aluminum salts have been shown to precipitate and coagulate most rapidly and with minimum solubility in some characteristic pH range. The optimum pH and effectiveness of various coagulant aids are investigated by jar tests. When coagulants are added, a mixing tank or basin is conventionally used ahead of the sedimentation tank or basin.

#### Chemical and Biological Treatment

Although subsurface injection is usually thought of as an alternative to surface treatment, certain chemical or biological treatment steps may be desirable or necessary. For example, it may be decided to neutralize an acidic or basic wastewater to reduce its corrosiveness, rather than to construct a corrosion-resistant system. Adjustment of pH in this case is for an entirely different purpose than in the coagulation step previously discussed; however, both purposes could be served in an appropriate situation.

Common chemicals that may be considered for wastewater neutralization are listed in Table 6-4. Dosage rates for acid and alkali neutralization are shown in Tables 6-5 and 6-6. Limestone or lime slurries have a tendency to form sludges of insoluble sulfates and reaction rates are slow. They are, however, useful in some cases (Larsen, 1967). Soda ash, which is more expensive, generally does not create excessive sludge; however, carbon dioxide is a reaction product. Caustic soda, the most expensive of the common alkalis, reacts almost instantaneously and creates less sludge. It also can be fed at higher concentrations than soda ash or lime, allowing compact feed equipment.

Sulfuric acid is most often used for neutralizing alkalis. Although it is highly corrosive when diluted, sulfuric acid can be stored at high concentrations in carbon steel containers. Compared to sulfuric acid, hydrochloric acid is usually more expensive, more corrosive and more volatile. It may cause atmospheric corrosion problems (Kirkarr, 1967).

TABLE 6-3A. SOME CHEMICAL COMPOUNDS USED AS COAGULANTS AND COAGULANT AIDS (AMERICAN PETROLEUM INSTITUTE, 1969).

COMPOUNDS	FORMULA	COMMERCIAL STRENGTH	GRADES AVAILABLE	WEIGHT (POUNDS PER CUBIC FOOT)	SUITABLE HANDLING MATERIALS	REMARKS
<u>Coagulants:</u>						
Aluminum sulfate	$Al_2(SO_4)_3 \cdot 18H_2O$	17 percent $Al_2O_3$	Lump Powder Granules	Powder: 38-45 Other: 57-67	Lead Rubber Silicon Iron	Coagulation and sedimentation systems; prior to pressure, filters for removal of suspended matter and oil.
Sodium aluminate	$Na_2Al_2O_4$	55 percent $Al_2O_3$	Crystals	50-60	Iron Steel Rubber Plastics	Usually added with soda ash to softeners.
Ammonium alum	$Al_2(SO_4)_3(NH_4)_2SO_6 \cdot 24H_2O$	11 percent $Al_2O_3$	Lump Powder	60-68	Lead Rubber Silicon Iron Stoneware	Coagulation systems-- not widely used.
Potash alum	$Al_2(SO_4)_3 \cdot K_2SO_4 \cdot 24H_2O$	11 percent $Al_2O_3$	Lump Powder	64-68	. . .	Coagulation systems-- not widely used.
Copperas	$FeSO_4 \cdot 7H_2O$	55 percent $FeSO_4$	Crystals Granules	63-66	Lead Tin Wood	Suitable coagulant only in pH range of 8.5 to 11.0.
Chlorinated copperas	$FeSO_4 \cdot 7H_2O + 1/2Cl_2$	48 percent $FeSO_4$	. . .	. . .	. . .	Ferrous sulfate and chlorine are fed separately.
Ferric Sulfate	$Fe_2(SO_4)_3$	90 percent $Fe_2(SO)_3$	Powder Granules	60-70	Lead Rubber Stainless steel Plastics	Coagulation--effective over wide range of pH, 4.0 to 11.0.
Ferric chloride hydrate	$FeCl_3 \cdot 6H_2O$	60 percent $FeCl_3$	Crystals	. . .	Rubber Glassware Stoneware	Coagulation--effective over wide range of pH, 4.0 to 11.0.

Coagulant Aids

NAME	FORMULA	COMMERCIAL STRENGTH	GRADES AVAILABLE	WEIGHT (POUNDS PER CUBIC FOOT)	SUITABLE HANDLING MATERIALS	REMARKS
Magnesium Oxide	MgO	95 percent MgO	Powder	25-35	Iron Steel	Essentially insoluble-- fed in slurry form.
Calcium Hydroxide	Ca(OH) <sub>2</sub>	93 percent Ca(OH) <sub>2</sub>	Powder	25-50	Iron Steel	Essentially insoluble-- fed in slurry form.
Sodium Silicate	Na <sub>2</sub> O(SiO <sub>2</sub> ) <sub>3-25</sub>	40 Bé solution	Solution	86	Iron Steel Rubber	...
Sodium Carbonate	Na <sub>2</sub> CO <sub>3</sub>	99 percent Na <sub>2</sub> CO <sub>3</sub>	Powder	34-52	...	pH adjustment and softening
Sodium Hydroxide	NaOH	98 percent NaOH	Flake Solid Ground Solution	...	...	pH adjustment, softening, oil removal systems.
Sulfuric Acid	H <sub>2</sub> SO <sub>4</sub>	100 percent H <sub>2</sub> SO <sub>4</sub>	Liquid	...	...	pH adjustment.

Commercial grades for which no information is available, suitable as coagulant aids are activated silica, clay, activated carbon, acidified starches, and ethyl cellulose.

TABLE 6-4. COMMON CHEMICALS USED FOR WASTE NEUTRALIZATION (ANON., 1968)

<u>Wastewater Character</u>	
<u>Acid Wastes</u>	<u>Alkaline Wastes</u>
Lime Slurries	Sulfuric Acid
Limestone	Hydrochloric Acid
Soda Ash	Carbon Dioxide
Caustic Soda	Flue Gas
Ammonia	Sulfur
Waste Alkali	Waste Acid

TABLE 6-5. ALKALI REQUIREMENTS FOR ACID NEUTRALIZATIONS (ANON., 1968)

<u>Alkali Source</u>	<u>Approx. Dosage</u> (lb/lb H <sub>2</sub> SO <sub>4</sub> )
Dolomitic Limestone	0.95
High Calcium Limestone	1.06
Dolomite Lime, Unslaked	0.53
High Calcium Limestone, Unslaked	0.60
Dolomitic Lime, Hydrated	0.65
High Calcium Lime, Hydrated	0.80
Anhydrous Ammonia	0.35
Soda Ash	1.10
Caustic Soda	0.80

TABLE 6-6. ACID REQUIREMENTS FOR ALKALI NEUTRALIZATIONS (ANON., 1968)

<u>Acid</u>	<u>Approx. Dosage</u> (lb/lb CaCO <sub>3</sub> )
H <sub>2</sub> SO <sub>4</sub> , 66°Be	1.0
HCl, 20°Be	2.0
Flue Gas, 15% CO <sub>2</sub>	3.0
Sulfur*	0.3

\*The use of sulfur would produce a reducing condition which might require additional treatment to produce an oxygen-containing effluent.



Carbon dioxide and sulfur dioxide may be fed directly from bottles into alkaline wastes, although this method is quite expensive and not used frequently (Perry and Frank, 1966). Treatment with flue gas, if available at the plant site is an alternative. Flue gas usually contains up to 14% by volume of carbon dioxide and is in common use. In some situations, burning sulfur to generate sulfur dioxide may be practical for neutralization. Nemerow (1971) devotes a short but well-written chapter to neutralization of industrial wastes.

Another chemical treatment step that might be desirable prior to injection is removal of heavy metals. These might be removed for their value, or they might be removed to prevent their precipitation after injection. Neutralization will cause precipitation of many metals. Other possible removal methods are ion exchange and oxidation or reduction. An example of a system in which metal recovery is applied is Beale Air Force Base, California, where silver is recovered by ion exchange before injection of a photo-processing waste (Warner, 1972).

In some cases, chemical or biological oxidation of organic chemicals may be employed to alter, reduce, or eliminate chemical or biological-oxygen demanding material. Such organic chemicals can be undesirable because they provide nutrients that support biological growth. Also, some organic chemicals are extremely viscous and others are unstable and subject to polymerization; both characteristics are undesirable in an injected wastewater.

In cases where a problem of incompatibility of injected and interstitial formation water is anticipated, the use of sequestering and chelating agents may be more practical and economic than other possible solutions. For example, when the wastewater contains a compound such as barium chloride and the formation water an incompatible ion such as sulfate, the barium ion can be complexed by adding a sequestering or chelating agent. Ostroff (1965, p. 91-90) provides a good review of the chemicals used for this purpose and their applications. Precipitation of calcium, magnesium, barium, strontium, iron, and other similar cations can also be prevented by exchanging these ions for a soluble ion such as sodium or by lime-soda ash water softening.

The forms of chemical and biological treatment mentioned are considered the most likely to be employed in pre-injection waste modification; however, others may occasionally be applicable. For further details of industrial wastewater treatment, textbooks on the subject can be consulted (Koziorowski and Kucharski, 1972; Nemerow, 1971; Ross, 1968; Eckenfelder, 1966; Sunnham, 1955).

#### Corrosion and Bacterial Control

Extremely important considerations in pre-injection wastewater preparation are provisions for control of corrosion and prevention of the growth of microorganisms. In this subsection, only chemical controls used for these purposes are considered. Use of corrosion resistant materials and biocidal action for corrosion control are covered elsewhere.

Addition of chemical corrosion inhibitors to a water may provide a simple and inexpensive solution to a corrosion problem that otherwise might require use of expensive corrosion resistant materials or water treatment equipment.

There are a wide variety of inorganic and organic compounds used as corrosion inhibitors. The conditions of the environment and type of corrosion govern the choice of inhibitor. Usually, the choice of inhibitor is based on the experience of the corrosion engineer and some trial-and-error testing. Some typical inorganic corrosion inhibitors are shown in Table 6-7, and typical organic corrosion inhibitors in Table 6-8.

Chemicals used to kill microorganisms are bactericides. Some inorganic chemicals are used as bactericides, for example chlorine, chromates, and compounds of mercury or silver. However, most currently used bactericides are organic chemicals. Some typical chemicals used as bactericides are listed in Table 6-9.

Brand-name bactericides contain one or more compounds of the type listed in Table 6-9, in varying amounts, as the active ingredients. The amount of active ingredient in a commercial bactericide determines its price and the quantity necessary for bacterial control. Service companies that supply bactericides for oil-field use should be consulted when selecting a preparation for microbial control in an injection water.

### Degasification

As discussed in Chapter 5, there are several common gases that may be entrained or dissolved in a wastewater and which may be corrosive particularly under higher pressure. These include oxygen, hydrogen sulfide, carbon dioxide, and methane.

Methods of degasification include:

1. Aeration
2. Heating
3. Vacuum degasification
4. Chemical degasification
5. Counter-current scrubbing

Aeration is a useful method of removing gases such as carbon dioxide and hydrogen sulfide. The difficulty with aeration is that the water becomes saturated with atmospheric oxygen, which also is undesirable because of its corrosivity.

Open heaters and closed deaerating heaters are used for removing oxygen and carbon dioxide from boiler feed water, but have not been found mentioned in connection with pre-injection water treatments.

TABLE 6-7. TYPICAL INORGANIC CORROSION INHIBITORS (GATOS, 1956).

Inorganic Inhibitors	Approximate Conc., %	Corrosion Environment	Metallic System
Borax	2-3	alcohol antifreeze mixtures	automobile cooling system
Calgon	small amount	water systems	steel
Disodium hydrogen phosphate	0.5	citric acid	steel
Potassium dichromate	0.05-0.2	tap water 68-194°F	iron-brass
Potassium dihydrogen phosphate + sodium nitrate	small amount + 5%	sea water	steel
Potassium permanganate	0.10	0.3N NaOH solution	aluminum
Sodium benzoate	0.5	0.03% NaCl solution	mild steel
Sodium carbonate	small amount	gas condensate wells	iron
Sodium chromate	>0.5	cooling water	electrical rectifier systems
Sodium chromate	0.07	CaCl <sub>2</sub> brine	Cu, brass
Sodium dichromate	0.025	water	air-conditioning equipment
Sodium dichromate + sodium nitrate	0.1 + 0.05	water	heat-exchange devices
Sodium hexametaphosphate	0.002	water, about pH = 6	lead
Sodium metaphosphate	small amount	ammonia	mild steel condensers
Sodium nitrite	0.005	water	mild steel
Sodium nitrite	20% of sea water	sea water-distilled water mixtures	mild steel
Sodium orthophosphate	1	water, pH 7.25	iron
Sodium silicate	small amount	sea water	Al, Al-Al alloys
Sodium silicate	0.01	oil field brine	steel pipes

TABLE 6-8. TYPICAL INORGANIC CORROSION INHIBITORS (GATOS, 1956).

Organic Inhibitor	Approximate Conc., %	Corrosion Environment	Metallic System
Benzanilide	0.2	lubricants	Cd-Ni, Cu-Pb bearings
Formaldehyde	small amount	oil wells	oil well equipment
Formaldehyde	0.05	sour crude oil	Diesel engines
Dioctyl ester of sulfosuccinic acid	0.05	refined petroleum oils	pipelines
Erthritol	small amount	K <sub>2</sub> SO <sub>4</sub> solution	mild steel
Ethylaniline	0.5	HCl solutions	ferrous metals
Mercaptobenzothiazole	1	HCl solutions	iron and steel
Morpholine	0.2	water	heat-exchange systems
Oleic acid	small amount	polyhydric alcohols	iron
Phenyl acridine	0.5	H <sub>2</sub> SO <sub>4</sub> solutions	iron
Pyridine + phenylhydrazine	0.5 + 0.5	HCl solutions	ferrous metals
Quinoline ethiodide	0.1	1N H <sub>2</sub> SO <sub>4</sub>	steel
Rosin amine-ethylene oxide	0.2	HCl solutions	mild steel
Tetramethylammonium azide	0.5	aqueous solutions or organic solvents	iron and steel
Thiourea	1	acids	iron and steel

TABLE 6-9. SOME TYPICAL CHEMICALS USED AS BACTERICIDES (OSTROFF, 1965, P. 165).

Type of Chemical Compound	Example Name	Compound Formula	Physical Form	Concentration Range (ppm)
Chromium	sodium chromate	$\text{Na}_2\text{CrO}_4$	solid	500
Mercury	mercuric chloride	$\text{HgCl}_2$	solid	50-300
Silver	silver nitrate <sup>16</sup>	$\text{AgNO}_3$	solid	0.05
Amine	coco primary amine acetate <sup>17</sup>	$(\text{R-NH}_3)^+(\text{CH}_3\text{CO-O})^-$	solid	10-40
Diamine	coco trimethylene diamine	$\text{C}_{12}\text{H}_{25}\text{-NH}(\text{CH}_2)_3\text{NH}$	liquid	5-25
Quaternary Ammonium <sup>18,19</sup>	alkyl trimethyl quaternary ammonium chloride	$\text{RN}(\text{CH}_3)_3\text{Cl}$	liquid	25-100
Imidazolines	1-phenyl-4,4-dimethyl,-imidazoline <sup>20</sup>	$\text{C}_3\text{H}_5\text{NCHNC}(\text{CH}_3)_2\text{CH}_2$	solid	75-100
Chlorinated	sodium tetrachlorophenate <sup>22,23</sup>	$\text{NaOC}_3\text{HCl}_4$	solid	12-50
Aldehydes	gluteraldehyde	$\text{C}_3\text{H}_3\text{O}_2$	liquid	20-75
Mercurials <sup>24</sup>	methyl mercuric acetate	$\text{CH}_3\text{Hg}(\text{COOCH}_3)_2$	solid	250
Peroxygens <sup>25</sup>	peracetic acid	$\text{CH}_3\text{COO}_2\text{H}$	liquid	10

Wright and Davies (1966) list deaerating columns using vacuum deaeration or counter-current gas scrubbing as the most feasible method for removing dissolved oxygen down to the level where the remainder can be removed by chemical scavengers. According to Watkins (1958) disadvantages of vacuum deaeration are that it is expensive, the mechanical removal of dissolved oxygen to a concentration of less than 1 ppm is difficult, and the removal of oxygen is usually accompanied by the removal of some free carbon dioxide. Carbon dioxide removal changes the carbon dioxide-bicarbonate balance and promotes precipitation of carbonates. The principals of counter-current gas scrubbing are discussed by Crawford (1955).

All materials used in deaerating columns should be resistant to a corrosive atmosphere. The shell of the columns should be lined with an epoxy material, the trays and other internal equipment should be of stainless steel.

Deaerating columns can also serve as small capacity surge tanks between the supply to the filtration equipment downstream and the discharge to the injection pumps. Monitors and controls should be provided to throttle the inlet or outlet and to maintain a liquid level within a predetermined range. More than one deaerating column should be provided to facilitate service and repair.

Industrial practice indicates that deaerators can reduce the dissolved oxygen content to 0.5 ppm or less. With the addition of chemical scavengers, the level can be reduced to 0.04 ppm or less, which results in effective corrosion control (Blout and Snavely, 1969). Such systems are kept closed downstream of the deaeration equipment, which requires that all vessels such as chemical mixing tanks, surge tanks, etc. be blanketed with an oxygen free, inert gas.

Chemical methods used to remove a gas from water depend upon a reaction between the gas and the chemical added to the water. This results in the selective removal of a specific gas, rather than using degasification to remove all dissolved gases, as in vacuum deaeration. The most important application of chemical degasification is for the removal of dissolved oxygen from water.

All chemical methods used to remove dissolved oxygen from water are based upon the reaction of oxygen with some easily oxidizable substance, the most commonly used being sodium sulfite (Templeton et. al., 1963) and hydrazine (Leicester, 1956). These chemicals are particularly useful for removing the small amounts of oxygen that remain after one of the physical deaeration processes.

## INJECTION PUMPS

There are many different types of equipment available for the pumping of liquids and for practical purposes they are divided into two distinctive types: (1) kinetic and (2) positive displacement. These classifications can be further broken down as illustrated in Table 6-10. The common types of injection pumps are centrifugal, turbine, piston-type duplex and multiplex plunger pumps. Centrifugal pumps have been used for low-pressure service

TABLE 6-10. GENERAL PUMP CLASSIFICATIONS (CLARK AND GEDDES, 1972).

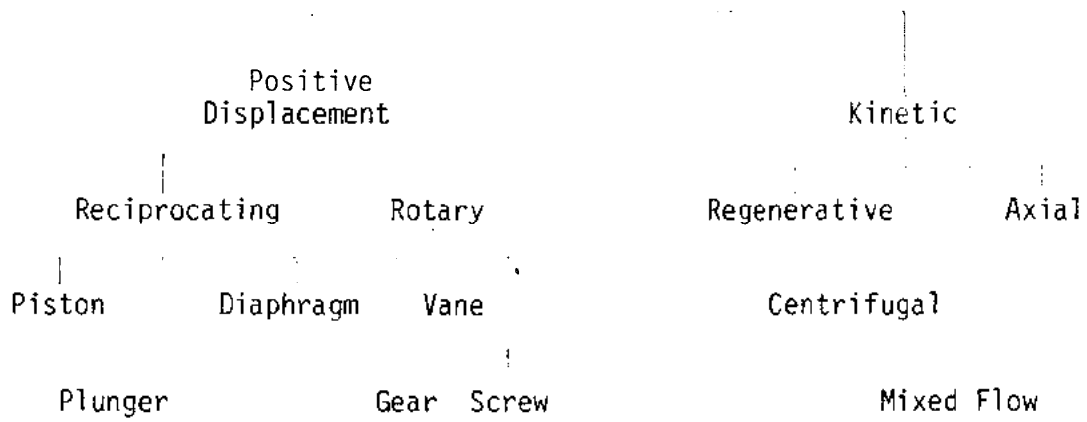

Increasing

Viscosity

(<300 psi), but turbine and single-stage centrifugal (Anon., 1964) pumps capable of operating at relatively high pressures are available (API, 1960). Duplex piston-type pumps operate satisfactorily at pressures up to 500 psi, and multiplex plunger pumps are adapted for higher pressures (Logan, 1956). The pump types to the left of the center line are more suited to handle high-viscosity liquids and high pressures (Clark and Geddes, 1972).

The most common type of pump used in disposal well systems is the centrifugal type, but reciprocating units also find wide use (Hicks and Edwards, 1971). Centrifugal pumps usually have heavy casing walls which give corrosion protection. Design provisions are made to keep corrosive and often very low pH or acidic liquids from exposure to the pump shaft. Provision for servicing of wearing parts is an important feature of all modern pumps.

The size, type and number of injection pumps is governed by:

- (1) the well-head pressure,
- (2) the volume of wastewater to be injected, and
- (3) the variability of injection rates.

A few installations do not require an injection pump because the wastewater in the well column exerts sufficient pressure at the subsurface face of the formation to drive the fluid into the formation. If the well-head pressure for waste injection is less than 150 psi, simple, single-stage centrifugal pumps can be used, but at higher pressures, multiplex piston-type or multi-stage centrifugal pumps are needed. Therefore, it may be necessary to delay selection of an injection pump until the well is ready for operation and pumping tests can be made.

#### EXAMPLES OF INTEGRATED TREATMENT FACILITY DESIGN

Many of the individual components and treatment processes used in the surface facilities of injection systems have been described. However, it remains to be shown how these are integrated into an overall pretreatment and injection plant. This will be accomplished by the use of selected examples for wastes with typical characteristics.

Detailed case histories of surface pre-injection treatment methods are readily available in the literature. Paper industry surface-treatment applications in Pennsylvania are described by Brown and Spalding (1966); chemical industry applications in Texas, Michigan and Alabama are reviewed by Veir (1969); Henkel (1955), Klotzman and Veir (1966): Texas; Paradiso (1955): Michigan; Tucker and Kidd (1973): Alabama. Steel industry surface-treatment applications are explored by Hartman (1966, 1968): Indiana; Smith (1969): Ohio; nuclear-related applications are reported by Arlin (1962): New Mexico; Halligan (1961): Colorado; Stage1 and Stogner (1969): U. S. general.

The single most comprehensive review of a number of case histories involving surface treatment can be found in the works by Donaldson, et. al. (1974). Warner (1972), the U. S. Environmental Protection Agency (1974), and



Reeder (1975) inventoried injection systems in the United States and, where available, provided brief descriptions of the surface facilities of each system.

### Simple Open System

Figure 6-9 depicts the surface equipment used in the case of an acidic waste that is not complicated with suspended solids or oils.<sup>1</sup> Also, in this case, the injection interval is a vugular limestone, a type of stratum that will often accept a wastewater that has had little or no pretreatment.

Because of the high permeability of the injection interval, no injection pump is needed and the absence of suspended solids precludes the need for filtration. Only a collecting sump and a metering valve to regulate the flow of waste into the well are required.

During normal operation, wastewater from various plant streams enters the sump, which has a metering weir near the outlet end to measure the rate of flow. A flow-control valve, regulated by a liquid-level meter in the outfall below the weir, is present to avoid sudden changes in the rate of flow into the well that could cause serious water hammer or surging. When the liquid level in the sump reaches a preset minimum, the control circuit closes the valve and prevents air from entering the well. A steel-jacketed polyethylene pipe is used to transport the wastewater from the control valve to the well-head; the fluid pressure in this pipe is monitored. The oil tank is for storage of light oil that is maintained under pressure in the annulus of the well to support the fiberglass tubing and to detect tubing leaks. A break in the tubing will cause an immediate change of pressure in the annulus which will be recorded by the pressure monitoring equipment.

### Semi-Complex Open System

Figure 6-10 is a schematic drawing of the surface equipment used in handling waste steel pickling liquor produced during the manufacture of steel. One step in the final processing of steel is the removal of iron oxides from the surface, just prior to cold rolling, by emersion in a solution of hydrochloric or sulfuric acid. The waste pickle liquor is the spent acid solution containing 13 to 25 percent iron by weight, principally as ferrous chloride or sulfate. In the particular example shown, the wastewater is a ferrous chloride-hydrochloric acid solution.

The pretreatment system is only slightly more complex than the first example. The waste is collected in a 35,000-gallon tank and pumped by three centrifugal pumps through a magnetic flowmeter for volumetric measurement. The waste is then filtered through leaf-type suspended filters to the discharge

<sup>1</sup>The wastewater is a mixture of a solution consisting of 31.1% hydrochloric acid, 3.3% sulfuric acid, and 65.6% water, and a solid content of 1.1% and contains related hydrocarbons (Reeder, 1977, p. 177).

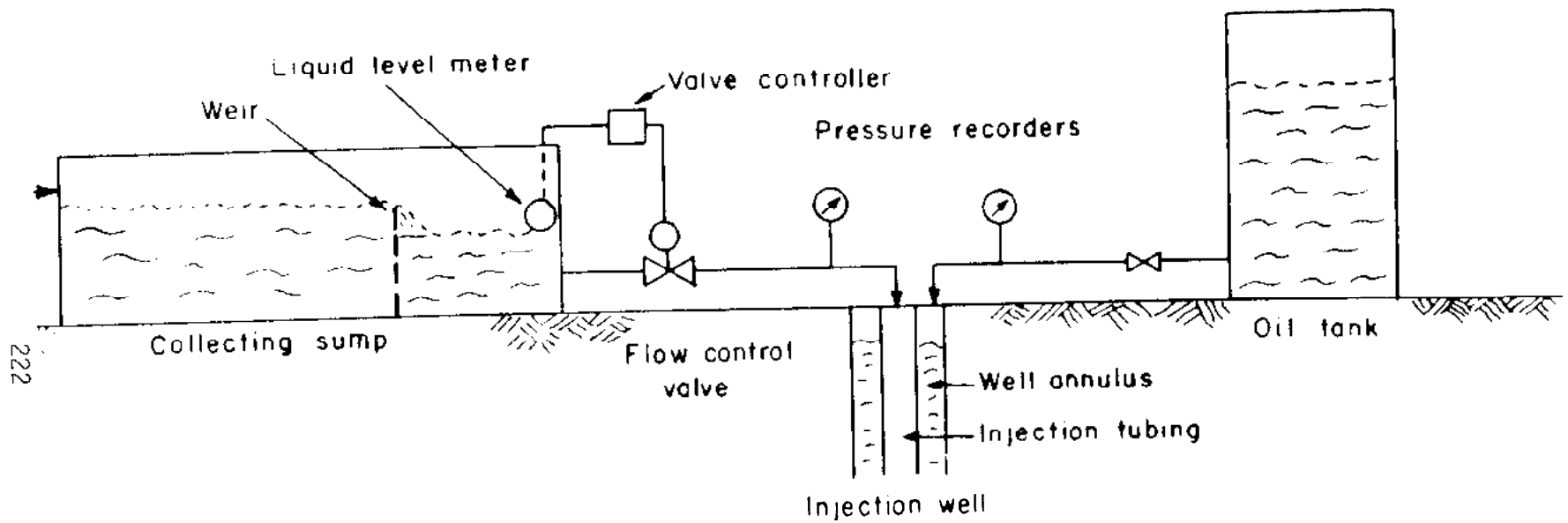

222

FIGURE 6-9. OPEN SURFACE EQUIPMENT USED IN A SIMPLE WASTE-INJECTION SYSTEM (DONALDSON, 1972).

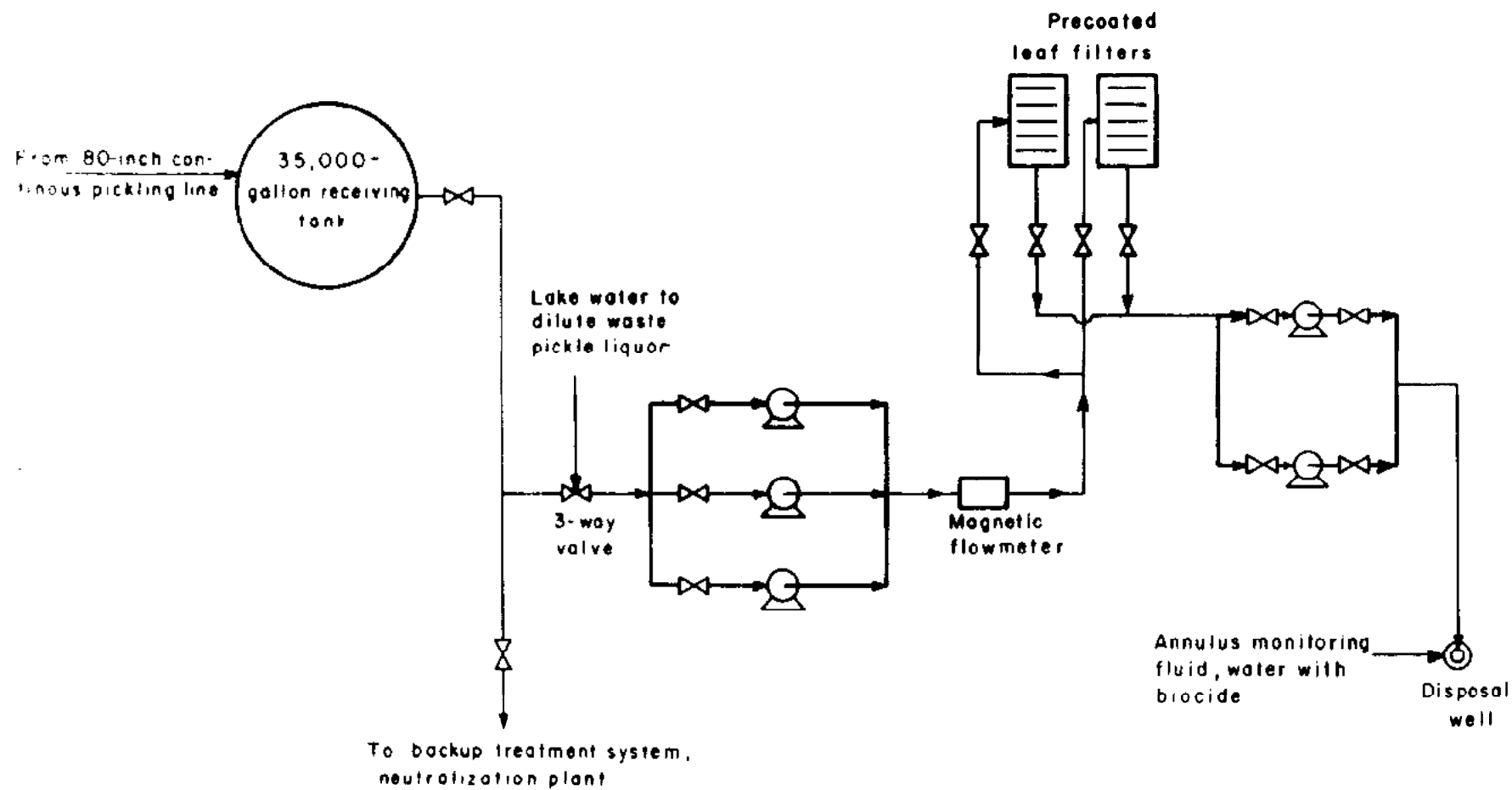

FIGURE 6-10. SURFACE EQUIPMENT FOR HANDLING WASTE HYDROCHLORIC ACID PICKLING LIQUOR FROM A STEEL PLANT (DONALDSON, 1974).

well that operates under gravity flow at 30 to 50 gpm injection rates. A backup surface treatment neutralization plant is provided in the event of a well shut-down.

In this system, wastewater is collected directly in a tank. In other cases a sump may be used ahead of the tank. According to Bayazeed and Donaldson (1971), regardless of the method practiced, the gathering system is constructed of acid-resistant materials. The sumps are generally constructed of brick cemented with resin, and the gathering tanks are constructed of rubber-coated steel. Transfer of waste pickle liquor is carried out with pipes and centrifugal pumps having all wetted parts made of epoxy resins, Teflon, or other acid-resistant materials.

#### Complex Open System (basic and acid wastes)

A relatively complex pre-injection treatment system is illustrated in Figure 6-11. The principal wastewater in this instance is basic and contains large amounts of suspended solids, some oil, and various inorganic and organic chemicals.<sup>1</sup>

The system was designed to treat the wastewater for injection into a limestone with low permeability. In the collecting pond, the oil is skimmed from the surface with an automatic skimmer that travels slowly across the pond, and the skimmed oil is burned in an incinerator. The waste liquor is then treated with coagulators to accelerate sedimentation of the suspended solids and with waste hydrochloric acid for pH control. The sludge from the coagulator and backwash of the filters is sent to a drying bed, and the under-drain is returned to the collecting pond.

A series of four leaf filters is used to filter the effluent from the coagulator, and the waste is then stored in a surge tank. The waste is pumped by multistage centrifugal pumps into a manifold at an average 1,100 gpm flow rate at 1,000 psi pressure (Veir, 1967).

Waste hydrochloric and nitric acid streams are collected in separate tanks and pumped into the injection-pump manifold. The waste acids are collected separately because the waste streams are not constant; whereas, if the acids were added directly to the collecting pond, they would cause wide variations in the pH of the composite waste.

#### Complex Open System (organic acids)

The surface equipment for pre-injection treatment of an organic wastewater is shown in Figure 6-12. The waste is an aqueous process waste solution containing approximately 5% (the percentage varies) water-soluble organ-

---

<sup>1</sup>The wastewater is a stream of containing NaHCO<sub>3</sub> (395 ppm); NaCl (9,100 ppm); CaSO<sub>4</sub> (1,360 ppm); Mg SO<sub>4</sub> (1,500 ppm); NH<sub>3</sub> (1,000 ppm); adipic acid (1,500 ppm); soluble organics (1,000 ppm); pH = 8.5. Waste HCl (6.0%) and HNO<sub>3</sub> (4.0%) are added at the injection pump manifold (Donaldson, 1972).

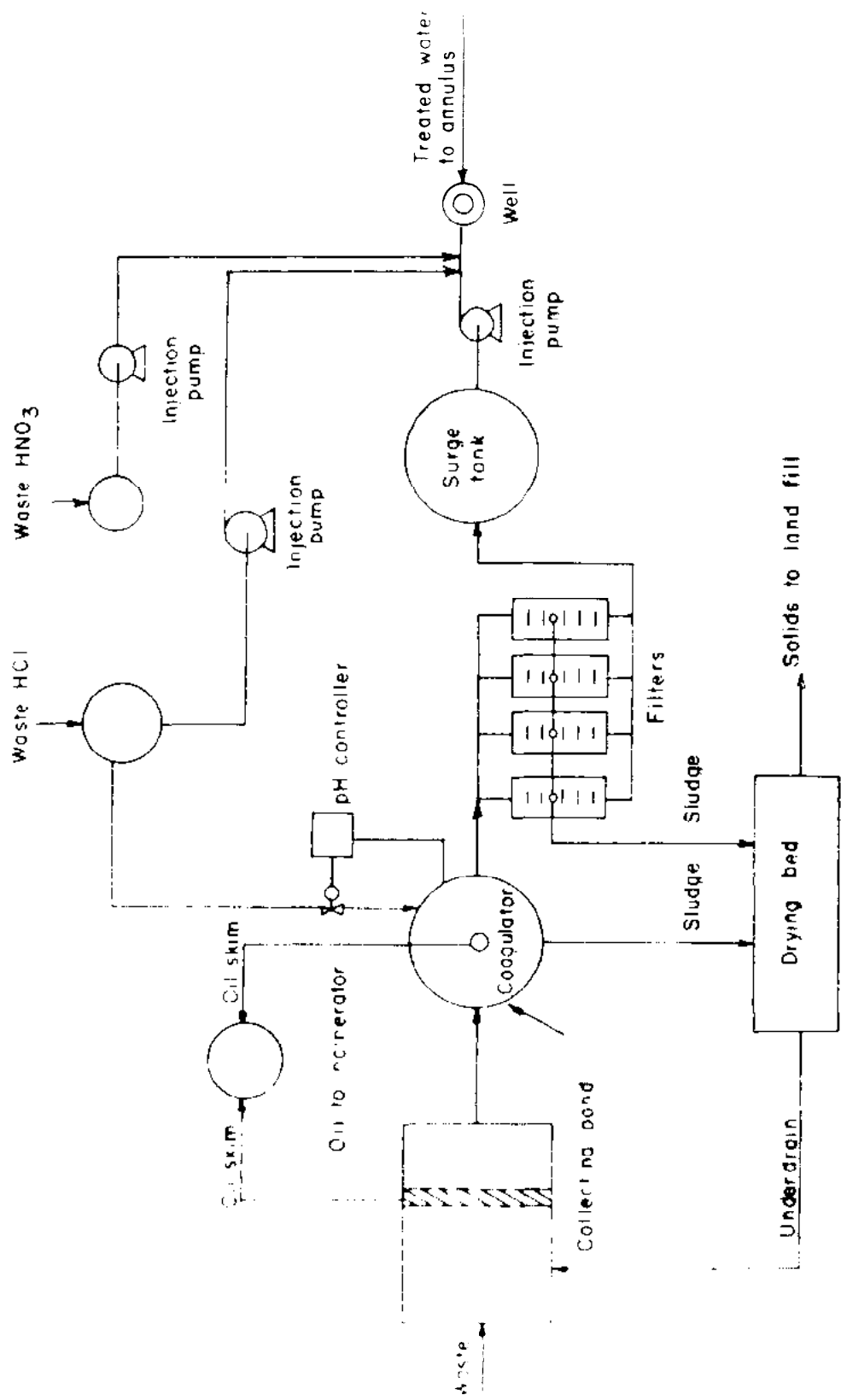

FIGURE 6-11. EXAMPLE OF A COMPLEX OPEN WASTEWATER PRE-TREATMENT SYSTEM FOR A MIXED WASTE (DONALDSON, 1972).

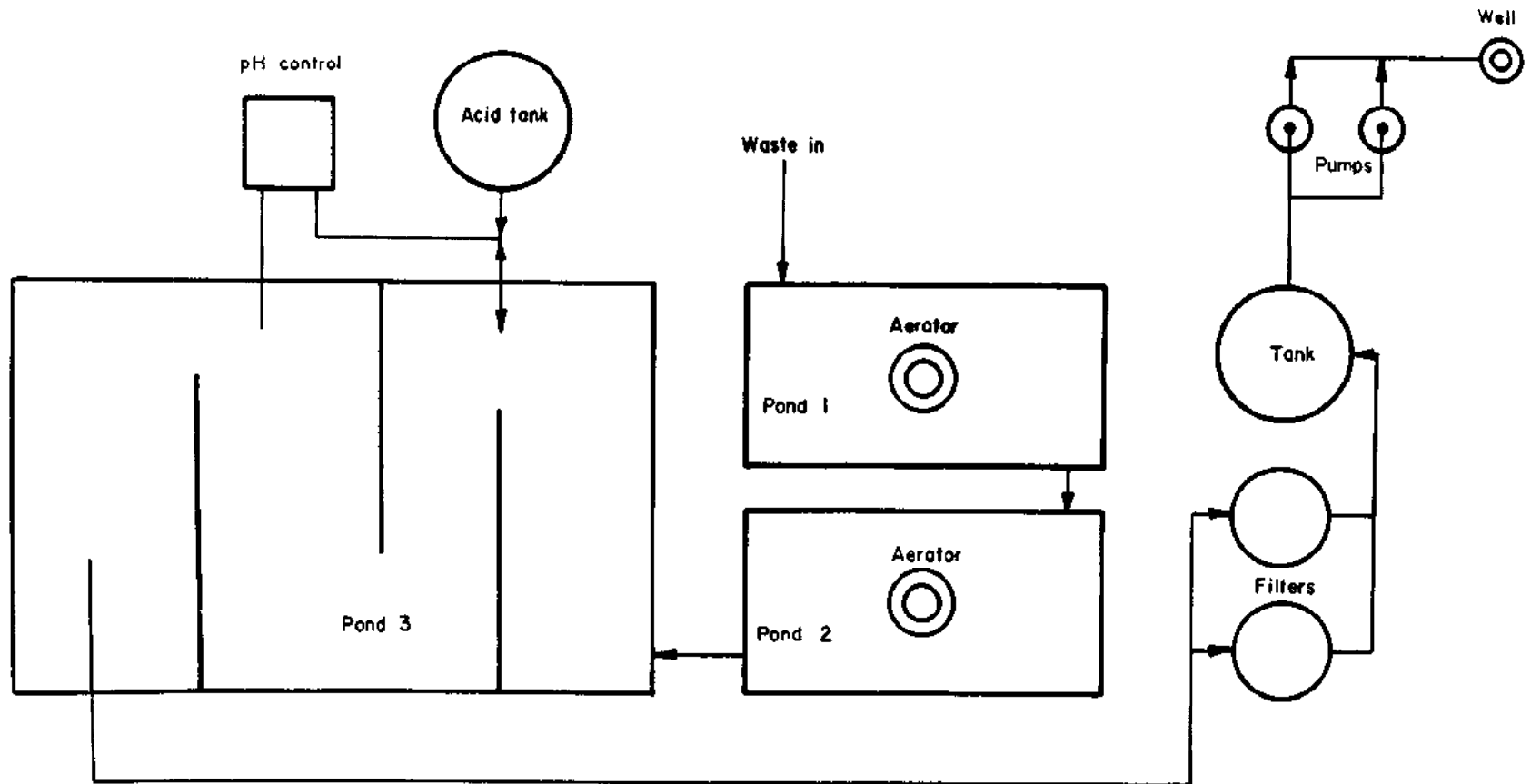

FIGURE 6-12. SURFACE PRE-INJECTION TREATMENT SYSTEM FOR PREPARATION OF THE WASTEWATER CHARACTERIZED IN TABLE 6-11 (DONALDSON, 1974).

ics after treatment. An analysis of a composite sample of the effluent being injected is given in Table 6-11.

The waste being injected originates from the manufacture of a polymer from acetylene and formaldehyde and is considered toxic. Pilot testing of compatibility was conducted and indicated that by controlling pH and by filtering, compatibility could be achieved. The wastewater from the processing units enters pond 1 where it is aerated to terminate the polymerization reaction. The fluid is then discharged over a weir into pond 2 where it is treated with lime and aerated a second time. Pond 3 is a sedimentation pond equipped with baffles. The waste is made slightly acidic (pH about 6.0) by automatic equipment that controls a valve on a hydrochloric acid storage tank. Some sludge-type organic material is precipitated in pond 3 and this is periodically vacuumed by a service company for land disposal. Waste water from pond 3 is filtered in an anthracite-sand pressure filter and stored in a 15-foot-diameter by 20-foot high tank. Two single-stage centrifugal pumps are connected in parallel for injection at the well. The injection rate ranges from 100 to 150 gpm.

#### Complex Closed System

A somewhat complex system designed for the pretreatment of an acidic wastewater containing volatile chlorinated hydrocarbons is shown in Figure 6-13. The wastewater is very low in pH, and contains hydrochloric acid, acetic acid, chloroacetaldehydes, and chloroacetic acids. The presence of low-boiling chlorinated hydrocarbons makes this a very reactive solution, which is extremely irritating to mucous membranes and to skin. Therefore, the waste is handled in a completely closed system.

The wastewater in the collection sump is not stable, forming polymers that precipitate upon standing. At a pH greater than 5.0, a tar-like polymer would be formed by condensation of the aldehydes. Therefore, the wastewater is pumped from the sump to a mixing tank where sodium hydroxide is used to stabilize the waste by increasing the pH from 2.5 to between 4.0 and 5.0.

Following pH control, the waste liquor is filtered in rack-type pressure filters that are designed for backwash and precoat operation as completely closed systems. The processed wastewater is stored in a surge tank equipped with a liquid-level meter that controls the operation of the injection pump. As a final precaution, just prior to injection into one or more wells, the wastewater is passed through a cartridge filter to remove any suspended solids that may have accumulated or formed during retention in the surge tank. Two single-stage centrifugal pumps connected in series are used to inject the waste at an average flow rate of 350 gpm and average well-head pressure of 400 psi.

The selection of materials for construction of the surface pre-injection treatment system was a critical design consideration because the wastewater is extremely corrosive to standard construction materials. Epoxy plastic pipe, Hastelloy C, 316 stainless steel, and titanium alloys were used where required.

TABLE 6-11. ANALYSIS OF AN ORGANIC WASTEWATER TREATED IN THE SURFACE SYSTEM SHOWN IN FIGURE 6-12 (DONALDSON, 1974).

Component	Concentration, ppm
Sodium hydroxide	1,297
Sulfuric acid	2,397
Hydrochloric acid	25.8
Acetylene	96.1
Formaldehyde	500
Propargyl alcohol	499
Methanol	2,305
Benzene	420
Butyl alcohol	92.4
Butanediol	918
Butyrolacetone	425
Tetrahydrofuran	518
Butyric acid	11
Ammonia	2,642
Pyrrolidone	268
Vinyl pyrrolidone	498
C-2's	122
Light ends	104
Gunk	114



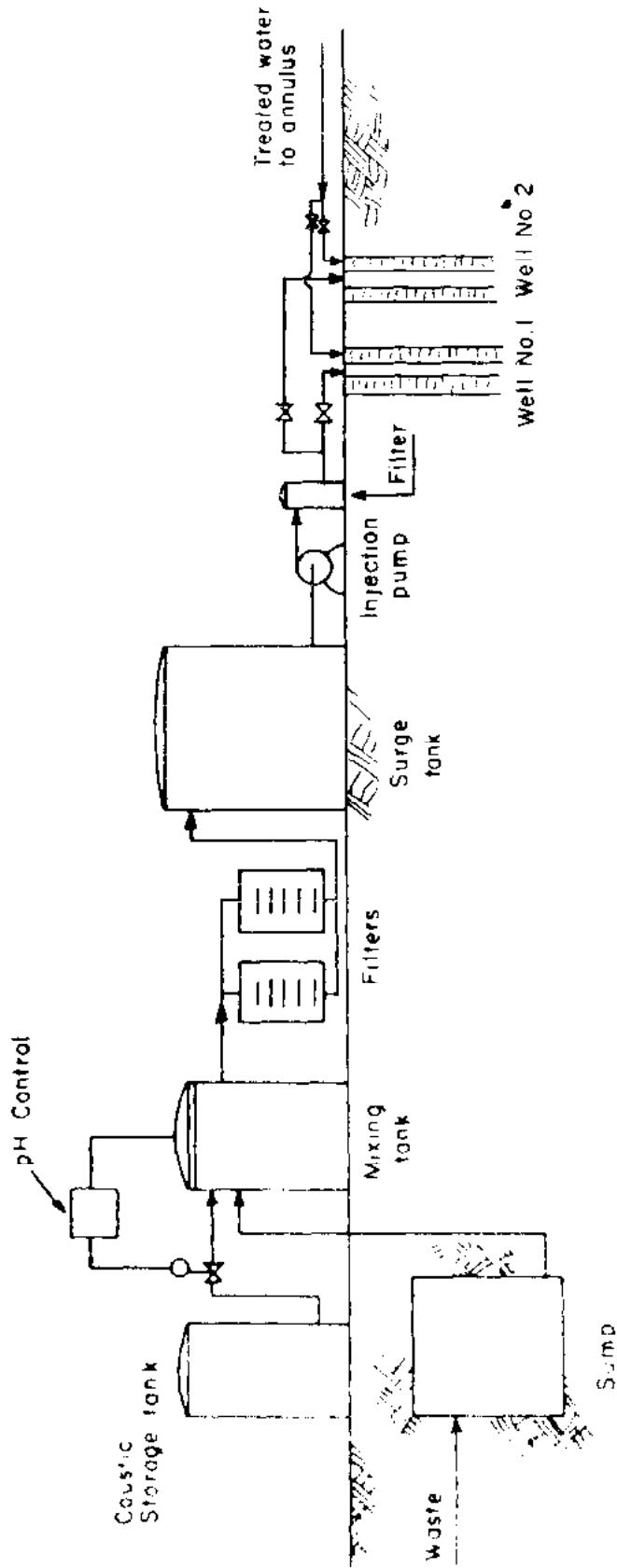

FIGURE 2.17. CLOSED SURFACE PRE-INJECTION EQUIPMENT USED FOR A WASTE CONTAINING VOLATILE ORGANIC COMPONENTS (DONALDSON, 1972).

## REFERENCES

### CHAPTER 6

- Anonymous. "Single-Stage Centrifugal Pump Gives Big Boost in Pressure." Oil & Gas Journal. Vol. 74. August 10, 1964.
- Anonymous. "Water Pollution Control." Chemical Engineering Deskbook on Environmental Engineering. October 14, 1968.
- American Petroleum Institute. Investigation of the Behavior of Oil-Water Mixtures in Separators. API, New York. 1951.
- American Petroleum Institute. Determination of Susceptibility of Oil to Separation. API Method 734-43. API, New York. 1953. 1 p.
- American Petroleum Institute. Subsurface Salt Water Disposal. Div. Production, Dallas, Texas. 1960.
- American Petroleum Institute. Manual on Disposal of Refinery Wastes. Volume on Liquid Wastes, Div. Refining, 20 chapters. Glossary and Index. First Edition. API, New York. 1969.
- American Water Works Association. Water Quality and Treatment. 3rd Edition. McGraw-Hill Book Co., New York. 1971.
- Arlin, Z. E. "Deep Well Disposal of Uranium Tailing Water." in 2nd Conference on Ground Disposal of Radioactive Wastes, Chalk River, Canada, 1961. J. M. Morgan et. al., eds. U. S. Atomic Energy Commission Rept. TID-7628. 1962. pp. 356-362.
- Baumann, E. R. "Diatomite Filtration of Potable Water." in Water Quality and Treatment. McGraw-Hill Book Co. 1971. pp. 280-294.
- Bayazeed, A. F., and Donaldson, E. D. "Deep-Well Disposal of Steel Pickling Acid." Society of Petroleum Engineers Paper. Number SPE 3615. 1971.
- Blout, F. E., and Snavely, E. S. "Use of Oxygen Meter in Corrosion Control." paper presented at 1969 NACE Conference. Houston, Texas. Preprint Paper No. 44. 1969.
- Brown, R. W., and Spalding, C. W. "Deep Well Disposal of Spent Hardwood Pulping Liquors." Water Pollution Control Fed. Vol. 38, No. 12. 1966. pp. 1916-1924.

- Clark, R. A., and Geddes, G. "Which Pump?" Engineering. November, 1972. pp. 1089-1092.
- Cohen, J. M., and Hannah, S. A. "Coagulation and Flocculation." in Water Quality and Treatment. McGraw Hill Book Co. New York. 1971. pp. 66-122.
- Crawford, P. B. "Aeration with Combustion Gases." Producers Monthly. Vol. 20, No. 1. 1955.
- Dillingham, J. H., and Baumann, E. R. "Hydraulic and Particle Size Characteristics of Some Diatomite Filter Aids." Journal American Water Works Association. Vol. 56, No. 6. 1964. pp. 793-808.
- Donaldson, E. C. "Injection Wells and Operations Today." Underground Waste Management and Environmental Implications. AAPG Memoir 18. 1972. pp. 24-26.
- Donaldson, E. C., et. al. "Subsurface Waste Injection in the United States -- Fifteen Case Histories." U.S. Bureau Mines I. C. 8636. 1974. 72 pp.
- Eckenfelder, W. W. Industrial Water Pollution Control. McGraw-Hill Book Co. New York. 1966.
- Gratos, H. C. "Inhibition of Metallic Corrosion in Aqueous Media." Corrosion. Vol. 12. 1956. pp. 23t-32t.
- Gurnham, C. F. Principles of Industrial Waste Treatment. John Wiley and Sons, Inc., New York. 1955.
- Halligan, E. G. "Deep Well Fluid Waste Disposal." in 2nd Conference on Ground Disposal of Radioactive Wastes, Chalk River, Canada. J. M. Morgan, et. al. (eds.). U.S. Atomic Energy Commission Rept. TID-7628. 1961. pp. 368-375.
- Hartman, C. D. "Deep-Well Waste Disposal at Midwest Steel." Iron and Steel Engineering. December, 1966. pp. 118-121.
- Hartman, C. D. "Deep-Well Waste Disposal of Steel-Mill Wastes." Journal Water Pollution Control Federation. Vol. 40, No. 1. January, 1968. pp. 95-100.
- Henkel, H. O. "Deep Well Disposal of Chemical Wastes." Chemical Engineering Progress. Vol. 51, No. 12. 1955. pp. 551-554.
- Hicks, T. G., and Edwards, T. W. Pump Application Engineering. McGraw-Hill Book Co., New York. 1971. 435 pp.
- Ingersoll, A. C. "The Fundamentals and Performance of Gravity Separation, A Literature Review." Proc. American Petroleum Institute. 1961. 31 pp.

- Klotzman, M., and Veir, B. "Celanese Chemical Pumps Wastes Into Disposal Wells." Oil and Gas Journal. Vol. 64, No. 5. 1966. pp. 84-87.
- Koziorowski, B., and Kucharski. Industrial Waste Disposal. Pergamon Press, New York. 1972. pp. 369.
- Krikau, F. G. "Neutralization is the Key to Acid-Liquor Waste Disposal." Chemical Engineering. November 18, 1968. pp. 124-126.
- Larsen, A. L. "Methods for Treating Surface and Subsurface Waters." Society Petroleum Engineers. Paper SPE-1831. 1967.
- Leichester, J. "The Chemical Deaeration of Boiler Water - The Use of Hydrazine Compounds." Transactions American Society Mechanical Engineers. Vol. 78. 1956. pp. 273.
- Logan, G. C. "What Injection Pump Fits Your Operation?" World Oil. Vol. 233. September, 1956.
- Nemerow, N. L. Liquid Waste of Industry Theories, Practices, and Treatment. Addison-Wesley Publishing Company, Reading, Massachusetts. 1971.
- Ohio River Valley Water Sanitation Commission. Perspective on the Regulation of Underground Injection of Wastewaters. Part II - Administrative Guidelines and Evaluation Criteria. Don L. Warner, Cincinnati, Ohio. 1969.
- Ostroff, A. G. Introduction to Oilfield Water Technology. Prentice-Hall, Inc., Englewood Cliffs, N. J. 1965.
- Paradiso, S. J. "Disposal of Fine Chemical Wastes." in Industrial Waste Conference No. 10, 1955, Proc. Purdue University Eng. Ext. Serv. 89. 1956. pp. 49-60.
- Permutit Company, The. Water Conditioning Handbook. The Permutit Company, New York. 1954.
- Perry, L. N., and Frank, W. J. "New Field Process Removes Oxygen from Injection Water." World Oil. June, 1966. pp. 125-128.
- Reeder, Louis, et. al. Review and Assessment of Deep-Well Injection of Hazardous Waste. Final Report for EPA Contract No. 68-03-2013. Program Element No. 1DB063. Solid and Hazardous Waste Research Laboratory, Cincinnati, Ohio. 4 Vols. July, 1975.
- Ross, R. D., ed. Industrial Waste Disposal. Environ. Eng. Series. Van Nostrand Reinhold Co., New York. 1968. 339 pp.
- Sadow, R. D. "Pretreatment of Industrial Waste Waters for Subsurface Injection." in Underground Waste Management and Environmental Implications. American Association Petroleum Geologists Memoir 18. Tulsa, Oklahoma. 1972. pp. 93-101.

- Slagle, K. A., and Stogner, J. M. "Oil Fields Yield New Deep Well Disposal Technique." Water and Sewage Works. June, 1969. pp. 238-244.
- Smith, R. D. "Burying Your Pickle Liquor Disposal Problem." Civil Engineering. Vol. 39, No. 11. 1969. pp. 37-38.
- Templeton, C. C., et. al. "Solubility Factors Accompanying Oxygen Scavenging with Sulfite in Oil Field Brines." Materials Protection. Vol. 2, No. 8. 1963. pp. 42.
- Tucker, W. E., and Kidd, R. E. Deep Well Disposal in Alabama. Geological Survey of Alabama. Bulletin 104. University of Alabama. 1973. 230 pp.
- United States Environmental Protection Agency. Compilation of Industrial and Municipal Injection Wells in the United States. EPA-520/9-74-020. Office of Water Program Operations, Washington, D. C. 2 Vols. October, 1974.
- Veir, B. B. "Celanese Deep Well Disposal Practices." Proc. 7th Ind. Water and Waste Conference. University of Texas. June 1-2, 1967. pp. 111-125.
- Warner, D. L. Survey of Industrial Waste Injection Wells. 3 Vols. Final Report. U. S. Geological Survey Contract No. 14-08-0001-12280. University of Missouri - Rolla (available from National Technical Information Service, Springfield, Virginia). 1972.
- Watkins, J. W. "New Trends in Treating Waters for Injection." World Oil. Vol. 146, No. 1. January, 1958. pp. 143.
- Wright, C. C., and Davies, D. W. "The Disposal of Oil Field Waste Water." Producers Monthly. September, 1966. pp. 14-24.

## CHAPTER 7

### INJECTION WELL DESIGN AND CONSTRUCTION

After the suitability of a possible injection well site has been confirmed regionally and locally, and the suitability of the wastewater to be injected has been determined, it is appropriate to develop a well design and construction program. Since the well is such an important part of the injection system, its proper design and construction are obviously fundamental to the success of the injection program. As has been found by experience, minor mistakes in design or construction can result in damage to the well and subsequent economic loss and possible degradation of the environment. The most common deficiency in well design has been inadequate provision for corrosion protection. In construction an oversight as small as improper selection of the drilling fluid used while drilling the injection interval can result in irreversible loss of permeability and possibly even in well abandonment.

#### PLANNING A WELL

The first step in planning a well is the acquisition of geologic and engineering information for the well site and for any previously constructed wells in the area. Determination of the geologic and engineering characteristics of the site will have been accomplished during the regional and local site evaluation. These characteristics must now be evaluated in view of their significance to well design and construction. Local experience in well design and construction is an invaluable aid in planning a well and the importance of obtaining information concerning local design and construction practices cannot be overemphasized.

#### Projected Geological and Engineering Conditions

Prior to the initiation of the well design phase, geological and engineering conditions will have been considered with regard to the feasibility of injecting the wastewater of concern and with regard to the environmental suitability of the site. The well designer must now consider how to match the well design and construction procedures to the expected conditions.

Briefly, the designer should know the anticipated maximum total well depth; the lithologic sequence to be penetrated; the anticipated location, thickness, and lithology of possible injection and confining intervals; the location of fresh-water-bearing aquifers; and the location of any possible mineral resources. These site characteristics are obtained in the ways previously discussed in Chapter 3.

## Previous Drilling Experience

The designer should take maximum advantage of information concerning wells previously drilled in the area. Such information includes bit records, drilling mud records, casing and cementing programs, and the driller's logs and drilling-time logs that are discussed in Chapter 3. Moore (1974) explains the nature and value of these various sources of information in some detail.

One of the items sought in the records of previous wells is the existence of any drilling hazards. Drilling hazards include lost circulation zones, zones of abnormal hole enlargement and sloughing and zones in which hole deviation or pipe sticking are problems. In an area where no wells have previously been drilled, the possibility of such hazards must be inferred from the projected subsurface geologic conditions.

## Completion Method

A major decision that is made early in the planning of a well is the choice of the bottom-hole completion method. When considered in detail, a wide variety of bottom-hole completion methods are used, but in general they can be categorized as methods applied to wells completed in competent formations and methods applied to wells completed in incompetent formations. Competent formations are limestones, dolomites, and consolidated sandstones that will stand unsupported in a borehole. The most commonly encountered incompetent formations are unconsolidated sands and gravels. They will cave readily into the borehole if not artificially supported. There are, of course, intermediate cases of formations that are generally competent but require some support for such purposes as preventing sloughing of occasional incompetent intervals or preventing fractured blocks from falling into the borehole.

The American Petroleum Institute (1955) described nine completion practices considered common in the petroleum industry, five methods applicable to caving formations and four applicable to competent formations. Examination of the records of wastewater injection wells that have been constructed in the United States (see the bibliography for Chapter 1) shows that almost all of the wells constructed thus far have been completed by one of three methods or close variations of them. The methods are:

1. Open hole completion in competent formations.
2. Screened, or screened and gravel-packed in incompetent sands and gravels.
3. Fully cased and cemented with the casing perforated in either competent or somewhat incompetent formations.

Figures 7-1a, b, and c are examples, respectively, of wells completed by the open hole, screen and gravel pack, and fully cased and perforated methods.

# OPEN-HOLE DESIGN

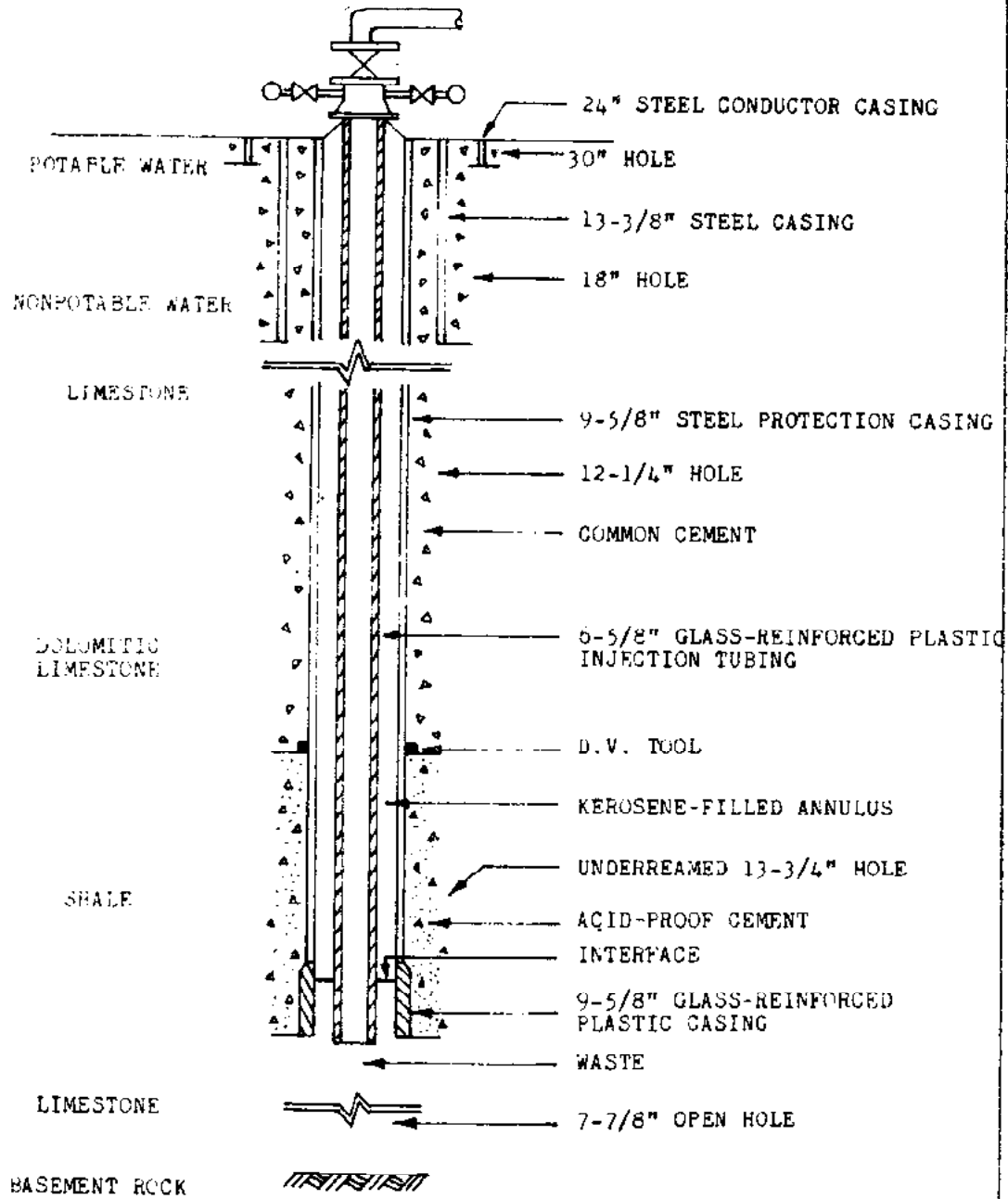

FIGURE 7-1a. EXAMPLE OF BOTTOM-HOLE COMPLETION BY OPEN HOLE METHOD (BARLOW, 1972).



## SCREENED OPEN-HOLE DESIGN

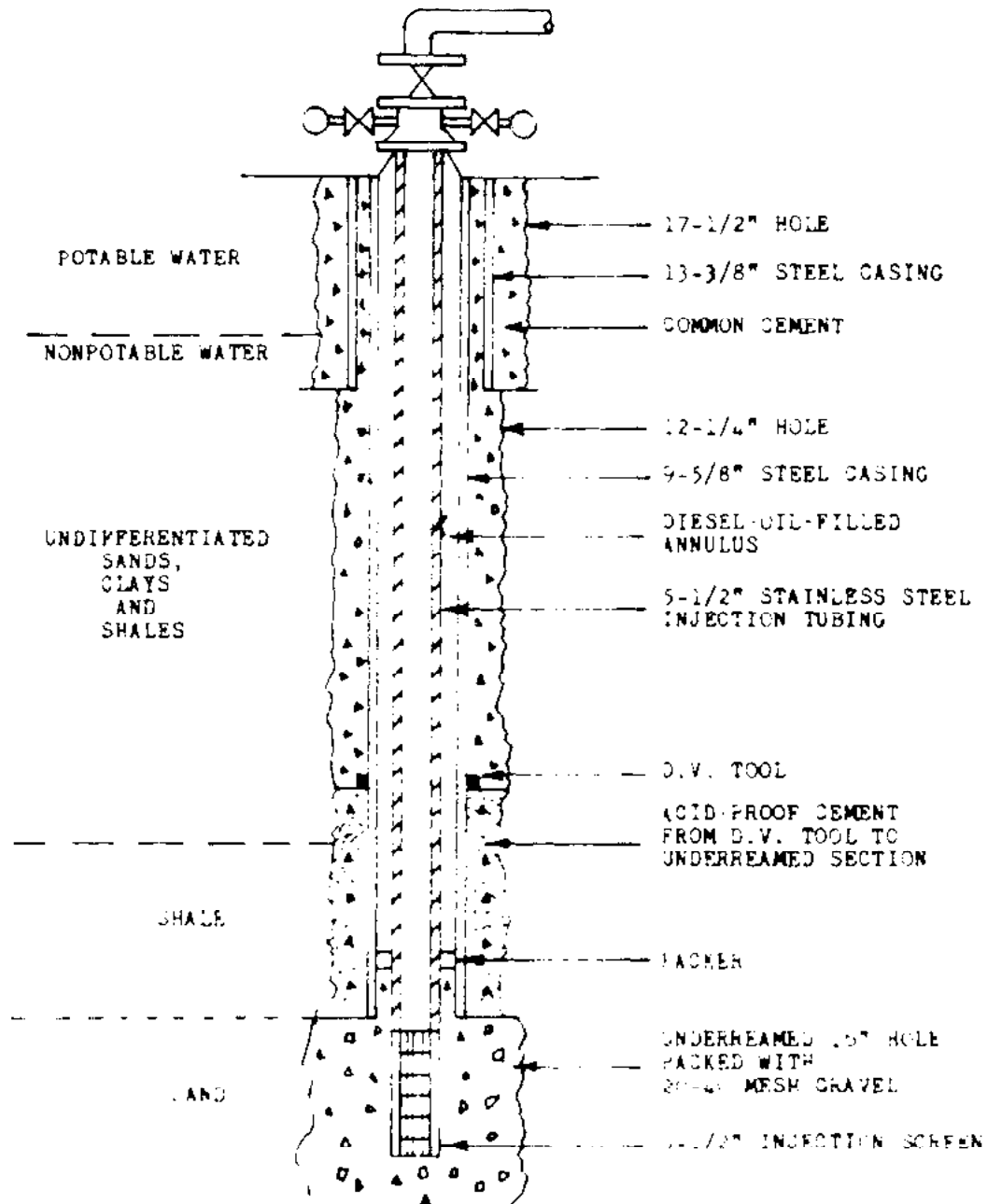

FIGURE 7-16. EXAMPLE OF BOTTOM-HOLE COMPLETION BY SCREEN AND GRAVEL-PACK METHOD. BARLOW, 1973.

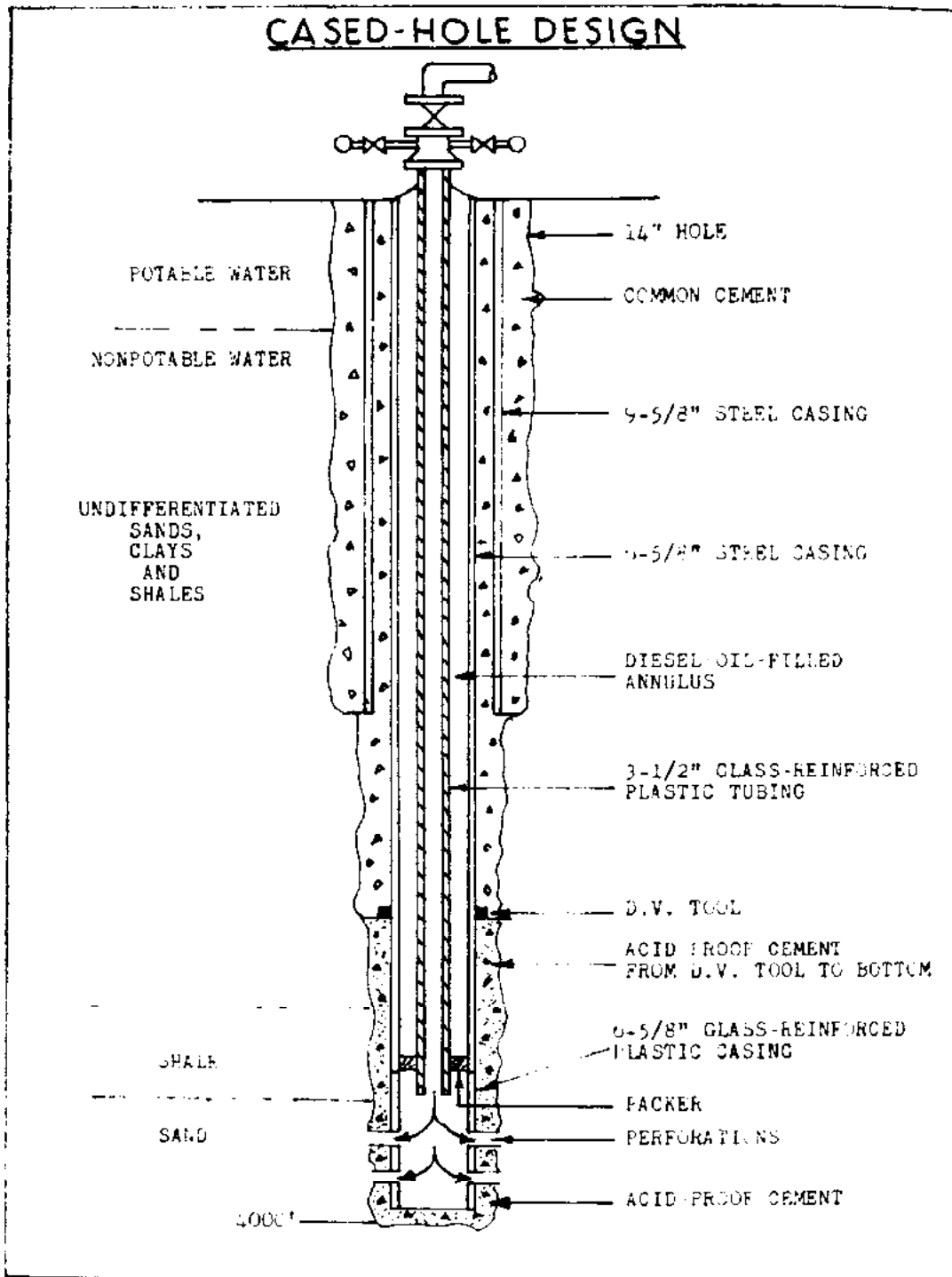

FIGURE 7-1c. EXAMPLE OF BOTTOM-HOLE COMPLETION BY FULLY CASED AND PERFORATED METHODS (BARLOW, 1972).

Open-hole completions are advantageous where they can be used, because all of the formation is open to receive wastewater, and little casing and no screen is subject to the corrosive action of the injected waste. Most wells in hard-rock areas such as Illinois, Indiana, Kansas, Michigan, Ohio, and Oklahoma are completed in this way.

Screened and gravel-packed wells are used principally in areas where partially consolidated or unconsolidated sands are the injection intervals. Such areas are the Gulf Coasts of Texas and Louisiana, and California.

In the third method, the injection casing is installed through the full depth of the well, and selected intervals are then opened up by perforating the casing and cement with a series of solid projectiles or small shaped explosive charges. Perforating is accomplished by lowering a perforating gun to the desired depth in the cased well, then firing it. Guns available from one service company are up to 15 feet in length and fire one to four shots per foot. If intervals thicker than 15 feet are to be perforated, multiple guns are used. Shot holes are generally less than one-half inch in diameter and the shots will penetrate the casing and several inches of concrete and/or rock. This method has been applied to wells in both hard and soft rock areas. It is relatively easy to construct wells in this way, but the performance of cased and perforated wells has not been as good as that of wells constructed by the other two methods. Probably the best use of the method is for recompleting wells at a shallower depth when additional injection capacity is needed or when it is necessary to abandon the original deeper injection interval.

#### Tubing, Casing & Borehole Program

Most wastewater injection wells will be constructed with injection tubing inside the long casing string, and with a packer set between the tubing and the casing near the bottom of the casing (Figure 7-2). This design is not entirely free of problems, particularly with the packer, but experience has proved it generally superior to other designs. Some wells are completed with an annulus open at the bottom. The annulus is filled with a lighter-than-water liquid which "floats" on the aqueous waste (Figure 7-1a). With wells completed with tubing, the first step in establishing the borehole and casing program is determination of the tubing size.

Tubing size is based on the volume to be injected, but there is no fixed relation between the two. For a specified waste volume, an increased tubing size requires less energy to force the wastewater through the tubing, but increases tubing cost. The optimum tubing size would minimize the cost of operation and still meet the engineering requirements of the system.

After determination of the tubing size, the inside diameter of the long or injection string is selected based on the following considerations:

1. Tubing diameter. The inside diameter of the casing must be great enough to accommodate the packer and tubing (coupling diameter).

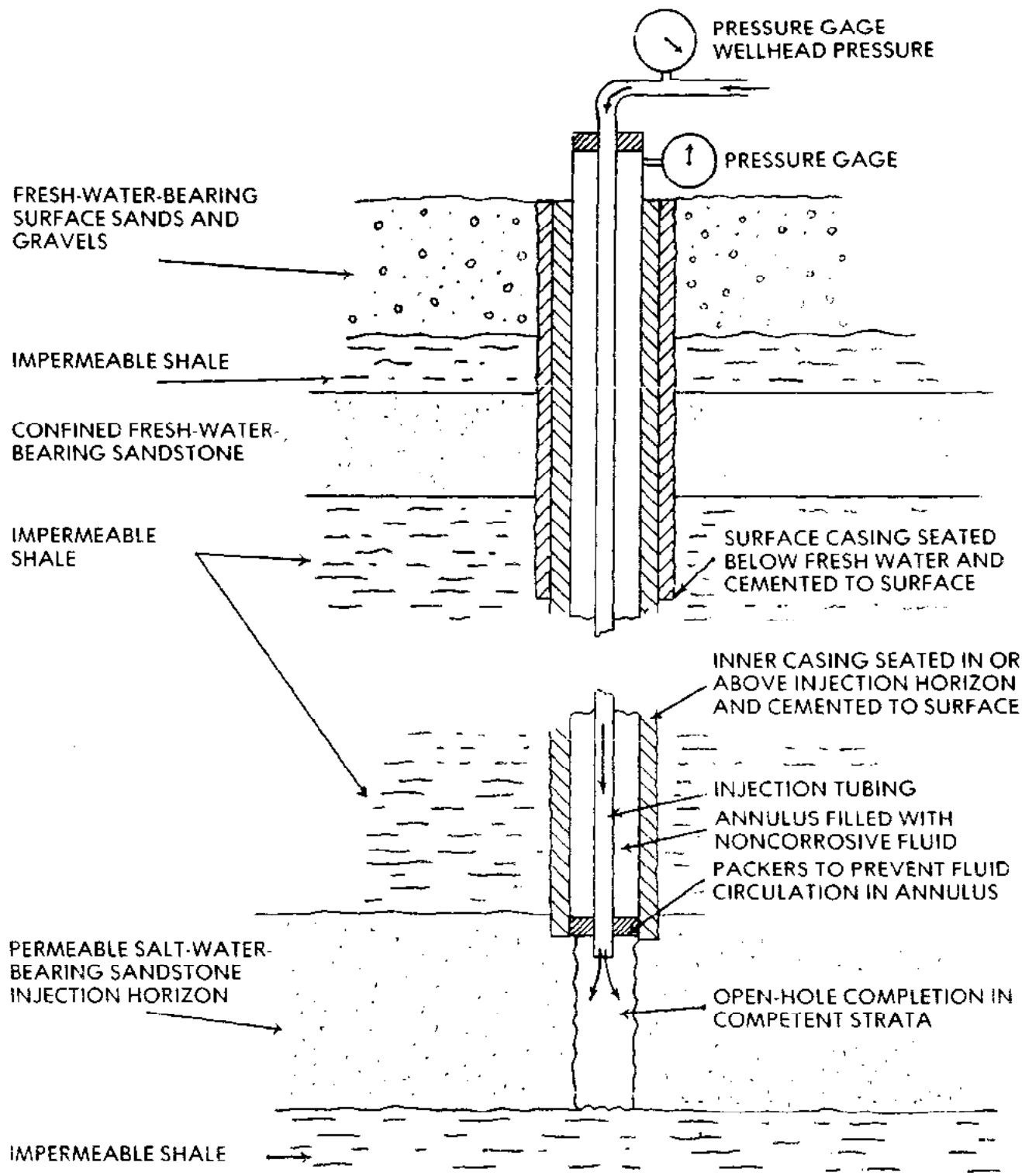

FIGURE 7-2. SCHEMATIC DIAGRAM OF AN INDUSTRIAL WASTE INJECTION WELL COMPLETED IN COMPETENT SANDSTONE (MODIFIED AFTER WARNER, 1965).

2. Cost of drilling and casing. Since the cost of drilling and casing increases with hole diameter, the size should be minimized.
3. Workovers. Since remedial work is frequently necessary in wastewater injection wells, the casing size must accommodate workover equipment. During their lifetimes, many injection wells require some form of maintenance ("workover" in the terminology of the petroleum industry). Workovers are commonly attempted for the following purposes:
  - a. Well repair
    - 1) Replace damaged tubing and/or packers
    - 2) Repair damaged or corroded casing
    - 3) Perform remedial well cementing
    - 4) Install additional liners or casing
  - b. Maintenance of injection capacity
    - 1) Reperforating
    - 2) Acidizing
    - 3) Fracturing
    - 4) Mechanical or hydraulic cleaning of the wellbore
  - c. Recompleting or deepening to a new injection interval
4. Common practice. The experience of others in the geologic area of interest and in similar operating situations should guide the final choice.

Once the inside diameter of the injection string has been selected, then its other characteristics are determined as discussed in the casing design section of this chapter. The decision on the size of the injection casing fixes the minimum size of the hole and of all other casing strings. The hole diameter should be at least two inches greater than the casing coupling outside diameter to allow at least a one-inch sheath of cement around the casing (American Petroleum Institute, 1959).

The number of casing strings and their setting points will be governed by the geologic conditions. There will normally be at least two casing strings as shown in Figure 7-2, the intermediate string and the surface casing string. An intermediate or protection string may also be run to support the borehole while drilling the next string below. The surface casing string is run as a precaution against the flow of surface water into the wellbore. It may also be run to isolate the surface aquifer from the subsurface aquifer. The intermediate string will be cemented to the wellhead and will be cemented to the surface casing string. The surface casing string will be cemented to the wellhead and will be cemented to the intermediate string.

## Samples

Samples of the rocks penetrated during drilling are always obtained either in the form of cuttings or as cores, as discussed in Chapter 4 except in unconsolidated formations, where they may not be obtainable. Cuttings are routinely obtained, but the number of sets and the collection frequency must be specified. The collection interval is normally 5, 10, or 20 feet, with 10 feet probably the most common. At least two sets of cuttings are usually obtained, one set for the well operator and a second set for the appropriate state agency.

Cores are expensive and time consuming to take and, normally are selectively taken only from the potential injection and confining intervals. In planning a well, the probable depth and footage of cores should be projected and arrangements made for the packaging and shipment of the cores to a core-analysis laboratory.

As with cores, samples of water are selectively taken and the approximate depth and number of water samples should be projected and the procedures for sample preservation, shipping, and analysis defined. Samples will usually be taken by drill-stem testing and it is advisable to contact the service company that will be performing the testing to establish that equipment and personnel will be available when needed.

## Geophysical Logging Program

The variety of available borehole geophysical logs is outlined in Chapter 3. In planning the well, the particular logs for determination of lithology and rock and formation fluid properties are selected. When choosing the suite of logs to be run, it is advisable to consult the logging companies that operate in the area to determine which logs have been found to be most suitable to the local geologic conditions and to insure that the selected service will be available when needed.

## Well Tests

At some stage in well construction, possible injection intervals will be tested. Initial testing will normally be drill-stem testing, during which reservoir properties are determined in a preliminary way and water samples are obtained. Later in well development, the most promising injection interval or intervals are tested more thoroughly by injectivity and/or pumping tests. Each of these types of tests and its interpretation is discussed in Chapter 3. In planning the well, thought should be given to the types of equipment needed to perform the injectivity and/or pumping tests and sources for the equipment identified. Arrangements for on-site facilities and materials needed for such tests also must be planned. For example, where will water be obtained for injectivity testing, how will the water be pretreated, and where will it be stored prior to injection?

## TUBING AND CASING DESIGN

### Tubing

It is recommended that wastewater injection be through tubing, which can be replaced, rather than through casing which cannot. Also, injection through tubing provides another level of protection to resources outside of the borehole and provides an additional opportunity for monitoring in the tubing-casing annulus.

Selection of injection tubing size is the first step in the actual well design. As previously mentioned, tubing size is based on the volume of wastewater to be injected. This is because the injection rate and tubing size determine the velocity of flow and, thus, the amount of pressure dissipated during flow through the tubing. Figure 7-3 gives the friction pressure loss per 100 feet of tubing for various sizes of tubing and casing and for water with a viscosity of one centipoise. Calculations for the chart also assume an "average" friction factor for the tubing and laminar flow. Friction pressure losses for circumstances significantly different than the assumed ones would have to be calculated from friction loss equations given in texts on fluid mechanics or petroleum engineering.

As a design example, the tubing and casing will be selected for the Midwest Fuel Recovery Plant site which is discussed in detail in Chapter 5. As discussed by Trevorrow et. al. (1977), the volume of tritium-bearing low-level radioactive aqueous waste that would be produced at such a plant would probably be about 35 gallons/minute, which is about 0.83 barrels/minute. Rounding this off to one barrel/minute, the friction loss for 1 1/4" tubing would be about 11 psi/100 feet and the total loss over the approximate 2000 of required tubing would be about 220 psi. This would be tolerable, but it would also probably increase surface injection pressures from 50 to 100 percent, thus requiring a larger and more expensive pump and motor. By going to 2 3/8 inch tubing, the total friction loss can be reduced to less than 40 psi and by going to 2 7/8 inch tubing, friction losses would be less than 20 psi. Either size would be suitable, and both are commonly used.

Tubing grade and weight are selected in the same manner as casing grade and weight, as is discussed in the next section.

Materials used for tubing range from ordinary steel, through plastic, to the more costly metals such as the various stainless steels; the nature of the waste is the determining factor. Commonly, sprayed-on plastic linings are adequate, provided a satisfactory seal can be made at the tubing couplings. Plastic tubing, particularly of the glass-reinforced type, is being used considerably. This tubing is ideal for some uses in wells which are not too deep. The main difficulty with plastic tubing is its low resistance to collapse and bursting.

Bimetallic tubing has been used successfully in some wells. This type of tubing has a thin-gage liner of resistant metal swedged to the base-metal wall. The liner is folded over the end of the pipe and welded in position.

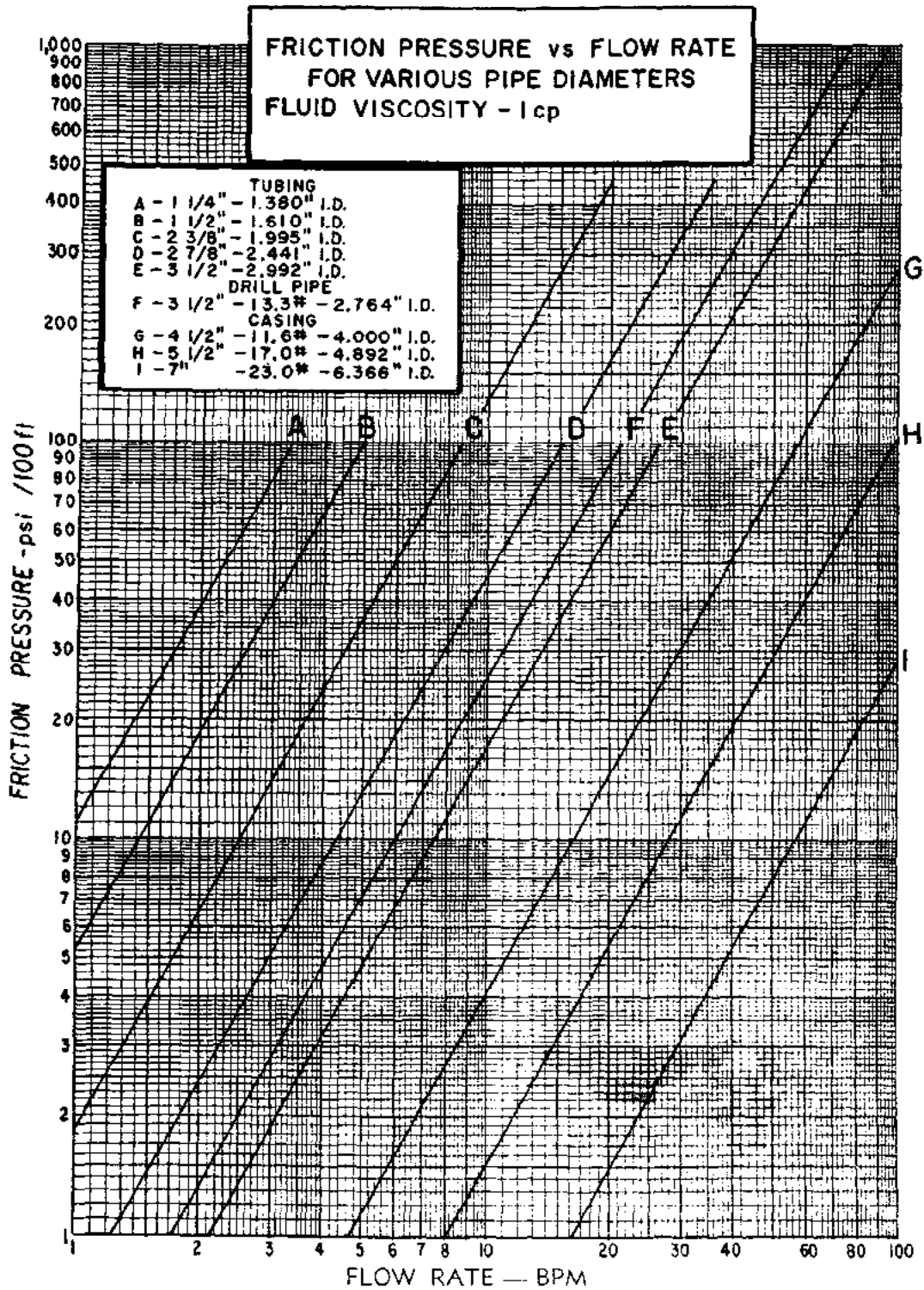

FIGURE 7-3. FRICTION PRESSURE LOSS VS. INJECTION RATE FOR COMMON TUBING AND CASING SIZES. (HALLIBURTON, 1963).



As with plastic-lined steel pipe, couplings utilizing a liquid-tight gasket seal must be used to prevent access of the waste to the unprotected steel of the coupling threads (Barlow, 1972).

### Casing

In constructing an injection well, the wall of the hole is lined with a heavy steel pipe, called casing. The primary functions of casing are to prevent the hole from caving in, confine injection to the wellbore and prevent contamination of upper fresh water bearing zones, and to provide a method of pressure control. Casing lengths of uniform outside diameter are called casing strings. Three types of strings may be used (but are not always necessary) in injection wells: a surface string, one or more intermediate strings (as dictated by geologic conditions), and an injection string.

Six properties determine casing type: wall thickness, outside diameter, nominal weight, length, joint specification, and construction material. A section of a casing string is a length of casing having the same wall thickness and joints, and being constructed of the same construction material (i.e. the same grade of steel); a string of varying sections is a combination string.

When selecting casing, it is necessary to design for three main forces: internal pressure, external pressure, and axial loading. Internal pressure would cause the casing to burst whereas external pressure would collapse the casing. Axial loading may be compressive due to buoyancy or tensive due to the hanging weight. In the case of axial tension, the hanging weight may cause the casing to "pull out" at a joint, or collapse due to decreased external pressure resistance.

The grade of steel casing is based on minimum yield strength as standardized by the American Petroleum Institute (API). Yield strength is the tensile stress which produces a total elongation of 0.5% of the length. Yield strengths of the API casing are given in Table 7-1.

TABLE 7-1. API CASING GRADES AND YIELD STRENGTHS,  
(AMERICAN PETROLEUM INSTITUTE, 1975).

GRADE	YIELD STRENGTH (PSI)
H-40	40,000
J-55	55,000
K-55	55,000
N-80	80,000

Other API standards have been established for the remaining casing properties (American Petroleum Institute, 1975). Normally, in designing casing strings, it is unwise to subject the casing to its maximum allowable stress and for this reason, design factors are used. The four main design factors are for yield strength, joint strength, collapse and burst. A study of design factors is reported by the American Petroleum Institute (1955-a).

The first step in casing design is selection of the diameter of the long or injection string, based on the tubing size previously chosen and on the criteria listed in the discussion of the tubing, casing, and borehole program. In this example, 7-inch OD casing is suggested. Although a smaller size could be used, it would limit the choice of packers and make remedial workovers more difficult. A decision on the size of the injection casing fixes the minimum size of the hole and all larger casing (Tables 7-3 and 7-4). The grade and weight of the casing will now be determined.

Design for internal pressure is the first step. As a general criterion, injection wells should be designed for the maximum possible internal stress that might be developed. This would be reservoir fracturing pressure. For this calculation, the fracturing pressure gradient will be assumed to be 1.5 psi/ft, with a balancing external reservoir pressure gradient of 0.5 psi/ft, leaving a net internal stress of 1.0 psi/ft. The total net internal stress in our 2,000 ft. injection casing would then be:

$$P_i = 2,000 \text{ ft} \times 1.0 \text{ psi/ft} = 2,000 \text{ psi}$$

If a design factor of 1.5 is applied, to allow for possible pressure surges and to avoid stressing the casing to near its yield point, maximum internal bursting pressure to design would be:

$$P_{id} = 2,000 \times 1.5 = 3,000 \text{ psi}$$

If J-55 and N-80 grades of casing are used, the following data apply:

TABLE 7-2. CHARACTERISTICS OF J AND N GRADES OF CASING  
(AMERICAN PETROLEUM INSTITUTE, 1975).

Grade	Min. Yield Strength psi	Nominal Weight lb/ft	Collapse Resistance psi	Internal Yield psi
J	55,000	20	2270	3740
J	55,000	23	3270	4360
J	55,000	26	4320	4980
N	80,000	23	3830	6340
N	80,000	26	5410	7240
N	80,000	29	7020	8160
N	80,000	32	8600	9060
N	80,000	35	10,180	9960
N	80,000	38	11,390	10,800

TABLE 7-3. RELATIONSHIP BETWEEN CASING SIZE, MINIMUM HOLE SIZE,  
AND MINIMUM RECOMMENDED BIT SIZE (BLUM, 1959).

Casing OD	Coupling OD	Recommended Clearance	Minimum Hole Size	Minimum Bit Size
4 1/2	5.000	1.000	6.000	6
5	5.563	1.250	6.813	7
5 1/2	6.050	1.250	7.300	7 3/8
6	6.625	1.750	8.375	8 3/8
6 5/8	7.390	1.750	9.140	9 1/2
7	7.656	2.000	9.656	9 3/4
7 5/8	8.500	2.500	11.000	11
8 5/8	9.625	3.000	12.625	13 3/4
9 5/8	10.625	3.250	13.875	14 3/4
10 3/4	11.750	3.250	15.000	15
11 3/4	12.750	3.500	16.250	17
13 3/8	14.375	3.500	17.875	18
16	17.000	3.500	20.500	20 3/4
20	21.000	3.500	24.500	25 1/2

TABLE 7-4. COMMON BIT SIZES (BLUM, 1959).

3 3/4	6	7 3/4	9 5/8	12 3/4
3 7/8	6 1/8	7 7/8	9 7/8	15
4 1/4	6 1/4	8 1/2	10 5/8	17 1/2
4 5/8	6 3/4	8 5/8	11	17 1/2
4 3/4	7 3/8	8 3/4	12	23
5 5/8	7 5/8	9	12 1/4	

\*All dimensions in inches.

By checking the internal yield column of Table 7-2, it can be seen that all of the casing listed will meet the internal yield pressure requirements.

Next, the external collapse pressure is determined from:

$$P_{cd} = 0.052 N_c \times P_c \times L$$

where:

$P_{cd}$  = external collapse design pressure

$N_c$  = design factor for collapse

$P_c$  = expected external collapse pressure gradient

$L$  = casing length

for this example:

$$\begin{aligned} P_{cd} &= 0.052 \times 1.125 \times 12 \times 2000 \\ &= 1404 \text{ psi} \end{aligned}$$

$P_c$  was chosen on the basis of the expected drilling mud weight of 12 lb/ft<sup>3</sup>. The design factor was obtained from Craft, et. al. (1962). Again, from Table 7-2, all of the casing meets the requirements in the collapse resistance criteria. Since all weights of casing will satisfy the pressure requirements thus far, select the lightest weight, J-55, 20 lb/ft. and calculate the maximum allowable length of this section. First, determine the maximum allowable suspended weight based on joint strength:

$$\begin{aligned} W_j &= F_j / N_j \\ &= 254,000 / 2.00 \\ &= 127,000 \text{ lb.} \end{aligned}$$

where:

$F_j$  = joint strength of API J-55,  
20 lb/ft casing, with short  
thread and coupling

$N_j$  = design factor (Craft, et. al., 1962)

Second, determine the maximum allowable suspended weight based on yield strength:

$$W_y = \frac{Y_m A_j}{N_a} = 55,000 \times \frac{4.198}{1.25} = 184,712 \text{ lbs.}$$

where:

$Y_m$  = minimum yield strength of J-55,  
20 lb/ft casing (Table 7-4)

$A_j$  = root thread area (Craft, et. al.,  
1962)

$N_a$  = design factor (Craft, et. al.,  
1962)

Therefore, the maximum suspended weight is limited by joint strength and the maximum length that can be suspended is

$$\frac{127,000}{20} = 6350 \text{ ft.}$$

which is greater than the setting depth. For this example, the injection string would consist entirely of J-55, 20 lb/ft, short thread casing. Although F-25 or H-40 casing grades are available in 7" outside diameter, only J-55 and N-80 grades were considered due to common usage.

Finally, the surface string must be designed. Since the surface casing is set in the hole prior to drilling for the injection string, the surface casing size will be determined so as to accommodate the drill bit for the injection string. Having selected a 7" outside diameter casing for the injection string, the minimum hole size for the injection string is found to be 9 7/8" from Table 7-3. API specifications indicate the minimum surface casing size that will allow the 9 7/8" drill bit is 10 3/4". Since this string will be only 100' long, to support the Maquoketa shale section, and is not dependent on the injection string weight, J-55 grade will be considered due primarily to availability (N-80 is eliminated due to the short length requirement).

Determining the necessary data as in the injection string, but for 10 3/4" OD casing:

TABLE 7-5. PROPERTIES OF J-55, 10 3/4 IN. CASING  
(AMERICAN PETROLEUM INSTITUTE, 1975 AND  
CRAFT ET. AL., 1962).

Grade	Min. Yield Strength psi	Nominal Weight lb/ft.	Collapse Resistance psi	Internal Yield psi
J	55,000	40.5	1735	3130
N	55,000	45.5	2300	3580
N	55,000	51.5	2875	4030

(Continued)

TABLE 7-5. CONTINUED

Root Thread Area in <sup>2</sup>	Minimum Joint Strengths	
	Short Thread lb.	Long Thread lb.
9.045	450,000	NA
10.616	518,000	NA
12.171	585,000	NA

Following the same general design procedures as for the injection string, J-55, 40.5 lb/ft casing with short threads and coupling is selected. The final casing design for the Midwest Fuel Recovery Plant is:

<u>Type</u>	<u>Injection Grade</u>	<u>Well Weight lb/ft.</u>	<u>Casing Interval ft.</u>	<u>Design Coupling</u>
Surface	J-55	40.5	0-100	short
Injection	J-55	20	0-2500	short

A thorough casing design analysis including necessary casing data is presented by Craft, et. al. (1962).

Because injection tubing and a packer are to be used, the majority of the casing can be of ordinary steel, but the last joints should be of a corrosion resistant metal. According to Long (1967), past experience in the nuclear industry has shown that stainless steels of types 309 SCb, 347, and 304 L are suitable in reprocessing operations and these metals would, thus, be ones to consider. Corrosion is discussed in detail in Chapter 5.

#### PACKER SELECTION

Packers are designed to seal off, or "pack off" certain sections in an injection well. They may be used to separate multiple injection zones, for casing protection from formation pressure and fluids, to isolate given injection zones, and as a subsurface safety control. There are three main types of packers: mechanical-set, hydraulic-set, and permanent packers. In order to set a packer and effectively seal off a reservoir zone, metal wedges, called slips, are forced against the casing wall to hold the packer in position and then the packing element is expanded to form a seal with the casing.

Mechanical set packers are seated by movement of the tubing. This may be accomplished by use of the tubing weight as in the case of a compression or weight-set packer; this packer may be retrieved by simply lifting up on the tubing.

Tension-set packers (as shown in Figure 7-4) are set by a pulling tension on the tubing; they are released by slacking off on the tubing. As can readily be seen, tension-set packers will be set even tighter by pressure from below and therefore work well in injection wells.

Rotational-set packers are set using a left-hand rotation to extend the slips; this procedure is reversed to release the packer. The primary advantage of rotational packers in injection wells is that the tubing may be landed in a neutral-weight situation, thus eliminating the possibility of unseating the packer due to tubing elongation (as when using a tension-set packer) or separating due to contraction (as when setting a weight-set packer.) The main disadvantage of rotational-set packers is that solids tend to settle out on top of the packer which prevents any rotational action; thus, on attempting to release the packer, the tubing is unscrewed. A brine water flush prior to retrieval will facilitate packer release.

The second major type of packer is the hydraulic-set packer which employs fluid pressure to wedge the slips; once set, this type of packer is usually held by a mechanical lock. Retrieval is by either rotation or tension. Hydraulic set packers are used particularly where tubing movement is limited. This type of packer also allows the tubing to be in a neutral-weight state.

A special type of the hydraulic-set packer is the inflatable or "balloon" packers which are used in open hole or cased wells. The packer element is set by applying fluid pressure. Primary usage occurs in wells with partially collapsed casing. Inflatables will not withstand high pressure differentials.

Permanent packers are set by either wireline, tubing, or even drill pipe. Normally, they are nonretrievable, but will withstand high pressure differentials. When set by wireline, a powder charge is ignited and the gas pressure sets the packer; when set with tubing or drill pipe, either hydraulic, tension, rotation or a combination of these methods may be used.

Another type of permanent packer is a cement plug; however, this technique is obviously very permanent. Packer expense is eliminated and leaks may be sealed by spotting cement. This technique consists of cementing the tubing in place and thus limits future workover possibilities.

## DRILLING THE WELL

Oil and gas wells are drilled primarily with rotary drills and this type of equipment is, therefore, the most readily available and widely used for drilling injection wells. Rotary drilling involves boring a hole by using a rotating bit to which a downward force is applied. The bit is attached to and rotated by steel drill pipe and collars through which a drilling fluid is circulated. Generally, the fluid leaves the drill string at the bit, thereby cooling and lubricating the cutting face of the bit. By flowing across the cutting surface, the drilling fluid drags rock cuttings from the hole bottom and transports them to the surface through the annulus between the drill string and the borehole wall. Figure 7-5 shows the components of a rotary drill string.

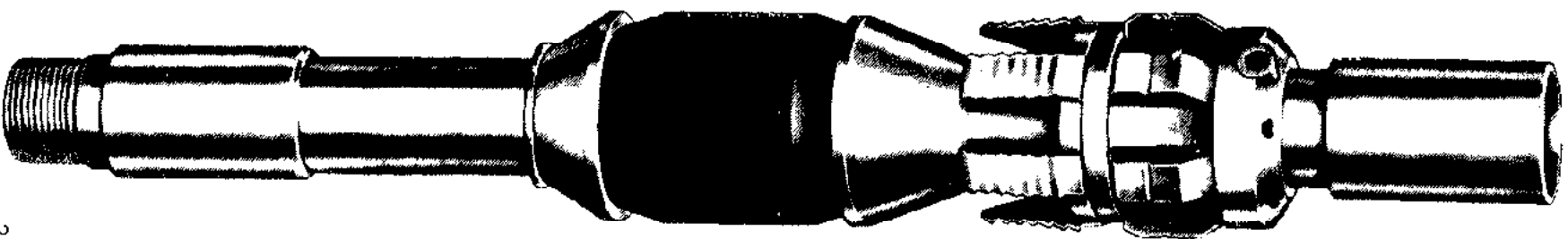

FIGURE 7-4. TENSION-SET PACKER  
(BUZARDE, ET. AL., 1972).



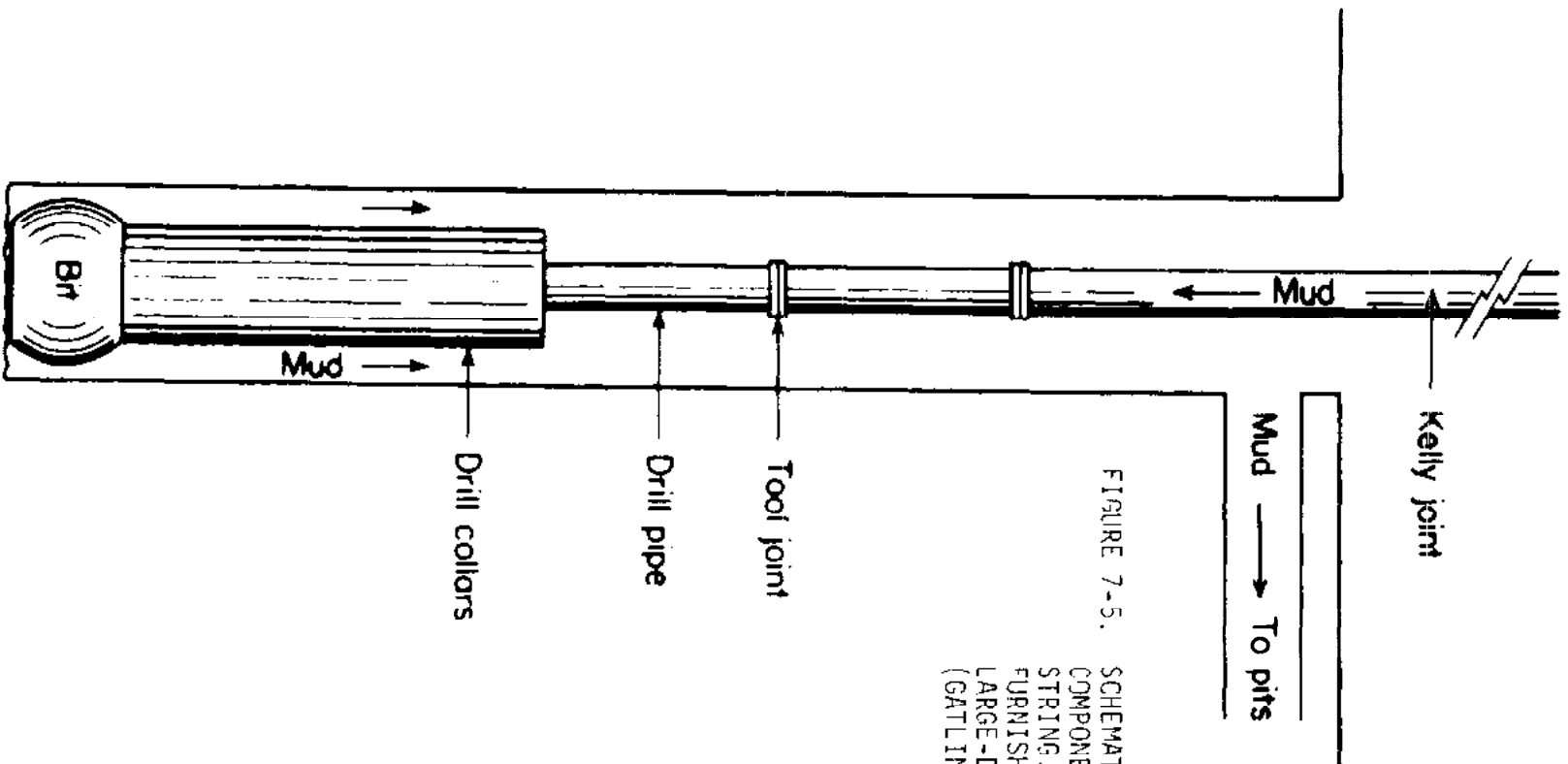

FIGURE 7-5. SCHEMATIC DIAGRAM OF THE COMPONENTS OF A ROTARY DRILL STRING. BIT LOAD IS FURNISHED BY HEAVY-WALLED, LARGE-DIAMETER DRILL COLLARS (GATLIN, 1960).

## Drilling Fluids

The fluid circulated in the borehole is extremely important in the rotary drilling operation. The drilling fluid may be plain water, water mixed with various additives, air or gas, or an oil-base fluid. The most common drilling fluid is water mixed with clays and other additives, which has led to the commonly used term "drilling mud." According to Gatlin (1960) and Moore (1974) the primary functions of the drilling fluid are:

1. Lifting cuttings from the bottom of the hole to the surface and to suspend cuttings at times when drilling is stopped.
2. To cool and lubricate the drill bit and drill string.
3. To control subsurface pressures.
4. To wall the hole with an impermeable mud cake.
5. To provide an aid to formation evaluation and to protect formation permeability.

Gatlin (1960) and Moore (1974) expand on these functions and discuss the properties and technology of drilling fluids. Planning of the drilling fluid program and control of the drilling fluids during drilling is extremely important to the success of an injection well. Moore (1974) states that "Many believe that any problems in drilling can be related to the drilling mud. As a general answer, mud cannot be blamed with all the problems; however, mud has been properly termed the heart of the drilling operation." Davis and Funk (1972) stress the importance of drilling fluid selection in order to minimize loss of permeability in the injection zone. Figure 7-6 shows the drilling mud circulation and treating system of a rotary drill rig.

## Drilling Hazards

Major hazards encountered during drilling are often spoken of as hole problems. Common hazards or hole problems include deviation from the vertical, lost circulation, hole enlargement and sloughing, and pipe sticking.

### Deviation --

No wells are truly vertical, but wells that deviate only slightly are considered vertical, for practical purposes. Severe hole deviation is undesirable because it creates difficulties in drilling, well completion, and well maintenance. While hole deviation cannot be entirely eliminated, it can be controlled. Gatlin (1960) and Moore (1974) discuss hole deviation and its control in detail.

### Lost Circulation --

Lost circulation is defined as the loss of substantial quantities of whole mud to a formation while drilling. This is evidenced by the complete

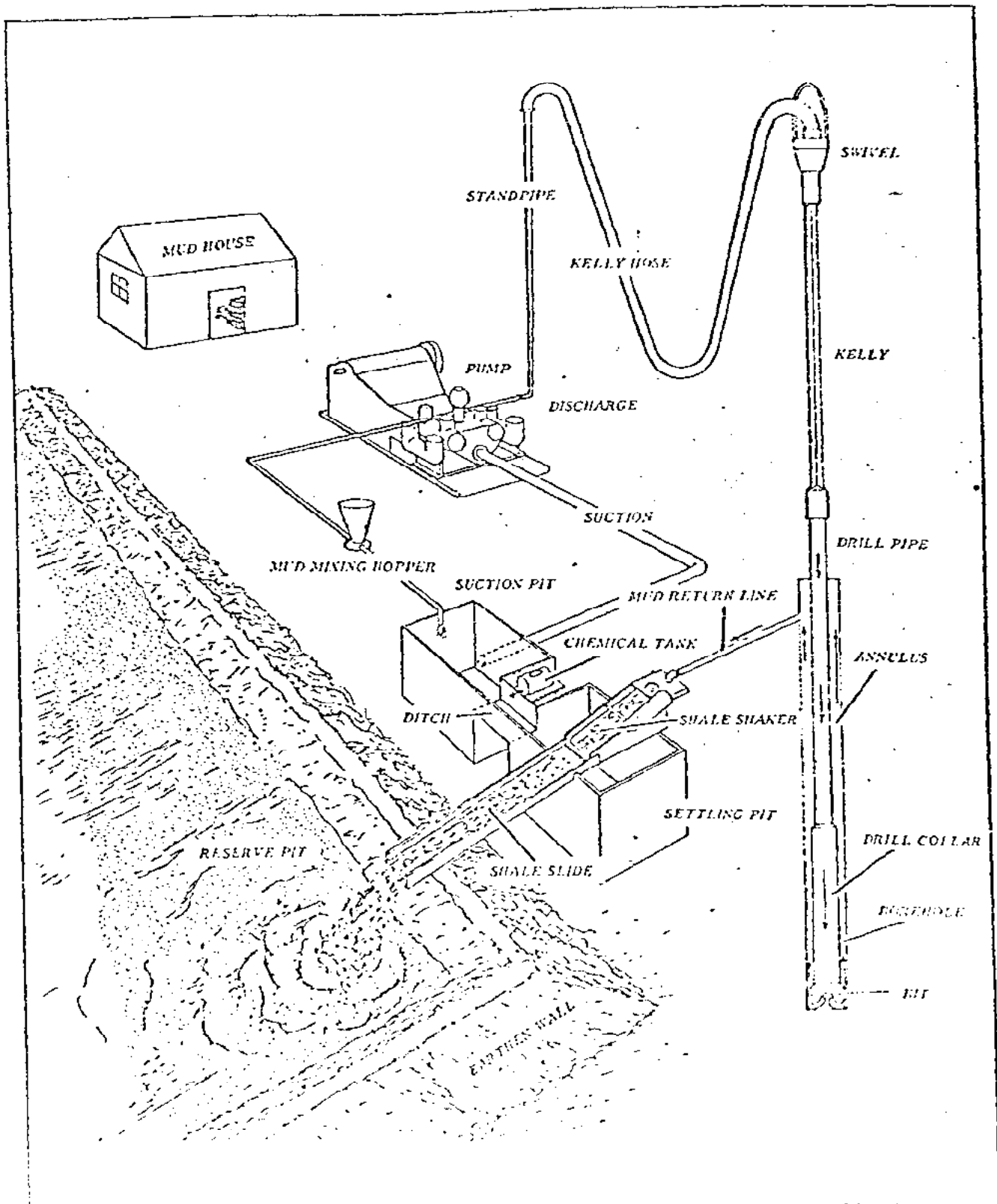

FIGURE 7-6. ROTARY RIG DRILLING MUD AND CIRCULATION AND TREATING SYSTEM (BE PROBLEM EXTENSION SERVICE, 1971).

or partial loss of return flow of mud. The annular mud level may drop out of sight and stabilize at a pressure in equilibrium with formation pressure. Lost circulation occurs when formation permeability is sufficiently great to accept whole mud. That is, the interconnected voids are too large to be plugged by the solids in the mud. A further obvious requirement is that the mud column pressure must exceed the formation pressure. Some of the undesirable effects of lost circulation are the following:

1. Mud costs prohibit continuance of drilling without returns.
2. No information on the formation being drilled is available since no cuttings are obtained.
3. The possibility of sticking the drill pipe with a resulting fishing job is increased.
4. Loss of drilling time and consequent cost increase is incurred.
5. If the lost circulation zone is a potential injection zone, considerable injectivity impairment may result.

The types of formations to which circulation may be lost have been classified in three groups:

1. Coarsely permeable rocks, such as gravels
2. Faulted, jointed, and fissured formations such as:
  - a. those with naturally occurring fractures
  - b. those in which the fractures are induced or caused by mud column pressures
3. Cavernous and open fissured formations.

Table 7-6 lists some identifying features of the types of lost-circulation zones.

Lost circulation is commonly combatted by introduction of "lost circulation" materials to plug or bridge the formation openings. Some types of lost circulation materials are:

1. Fibrous materials: hay, sawdust, bark, cottonseed hulls, cotton bolls, cork.
2. Lamellated (flat, platy) materials: mica, cellophane.
3. Granular bridging materials: nut shells, perlite, pozzolanic materials, ground plastic.

Fibrous and lamellated materials are most effective in coarsely permeable rocks where the voids are relatively small. Larger openings require

TABLE 7-6. IDENTIFYING FEATURES OF LOST CIRCULATION ZONES (HOWARD AND SCOTT, 1951).

Unconsolidated Formations	Natural Fractures	Induced Fractures	Cavernous Zones
<p>1. Gradual lowering of mud level in pits.</p> <p>2. Loss may become complete if drilling is continued.</p> <p>3. Since it is known that the rock permeability must exceed about 10 darcys before mud can penetrate and that oil or gas sand permeability seldom exceeds about 3.5 darcys, it is improbable that loose sands are the cause of mud loss to an oil or gas sand, unless the loss can be attributed to the ease with which this type of formation fractures.</p>	<p>1. May occur in any type rock.</p> <p>2. Loss is evidenced by gradual lowering of mud in pits. If drilling is continued and more fractures are exposed, complete loss of returns may be experienced.</p>	<p>1. May occur in any type rock, but would be expected in formations with characteristically weak planes.</p> <p>2. Loss is usually sudden and accompanied by complete loss of returns. Conditions are conducive to the forming of induced fractures when mud weight exceeds 10.5 lb/gal.</p> <p>3. Loss may follow any sudden surges in pressure.</p> <p>4. When loss of circulation occurs and adjacent wells have not experienced lost circulation, induced fractures should be suspected.</p> <p>5. Can be competent or incompetent formations.</p>	<p>1. Normally confined to limestone.</p> <p>2. Loss of returns may be sudden and complete.</p> <p>3. Bit may drop from a few inches to several feet just preceding loss.</p> <p>4. Drilling may be "rough" before loss.</p>

TABLE 7-7. SUMMARY OF WELL CEMENTING  
ADDITIVES (SMITH, 1976)

Type of Additive	Use	Chemical Composition	Benefit	Type of Cement
Accelerators	Reducing WOC time Setting surface pipe Setting cement plugs Combatting lost circulation	Calcium chloride Sodium chloride Gypsum Sodium silicate Dispersants Sea water	Accelerated setting High early strength	All API Classes Pozzolans Diacel systems
Retarders	Increasing thickening time for placement Reducing slurry viscosity	Lignosulfonates Organic acids CMHEC Modified lignosulfonates	Increased pumping time Better flow properties	API Classes D, E, G, and H Pozzolans Diacel systems
Weight-reducing additives	Reducing weight Combatting lost circulation	Bentonite-attapulgate Gilsonite Diatomaceous earth Perlite Pozzolans	Lighter weight Economy Better fillup Lower density	All API Classes Pozzolans Diacel systems
Heavy-weight additives	Combatting high pressure Increasing slurry weight	Hematite Ilmenite Barite Sand Dispersants	Higher density	API Classes D, E, G, and H
Additives for controlling lost circulation	Bridging Increasing fillup Combatting lost circulation	Gilsonite Walnut hulls Cellophane flakes Gypsum cement Bentonite-diesel oil Nylon fibers	Bridged fractures Lighter fluid columns Squeezed fractured zones Minimized lost circulation	All API Classes Pozzolans Diacel systems

(Continued)

TABLE 7-1. Continued

Type of Additive	Use	Chemical Composition	Benefit	Type of Cement
Filtration-control additives	Squeeze cementing Setting long liners Cementing in water-sensitive formations	Polymers Dispersants CMHEC Latex	Reduced dehydration Lower volume of cement Better fill-up	All API Classes Pozzolans Diacel systems
Dispersants	Reducing hydraulic horsepower Densifying cement slurries for plugging Improving flow properties	Organic acids Polymers Sodium chloride Lignosulfonates	Thinner slurries Decreased fluid loss Better mud removal Better placement	All API Classes Pozzolans Diacel systems
Special cements or additives				
Salt	Primary cementing	Sodium chloride	Better bonding to salt, shales, sands	All API Classes
Silica flour	High-temperature cementing	Silicon dioxide	Stabilized strength Lower permeability	All API Classes
Myl 401	Neutralizing mud-treating chemicals	Paraformaldehyde	Better bonding Greater strength	API Classes A, B, C, G, and H
Radioactive tracers	Tracing flow patterns Locating leaks	Sc 46	--	All API Classes
Pozzolan lime	High-temperature cementing	Silica-lime reactions	Lighter weight Economy	--
Silica lime	High-temperature cementing	Silica-lime reactions	Lighter weight	--

(Continued)

TABLE 7-7. Continued

Type of Additive	Use	Chemical Composition	Benefit	Type of Cement
Gypsum cement	Dealing with special conditions	Calcium sulfate Hemihydrate	Higher strength Faster setting	--
Hydromite	Dealing with special conditions	Gypsum with resin	Higher strength Faster setting	--
Latex cement	Dealing with special conditions	Liquid or powdered latex	Better bonding Controlled filtration	API Classes A, B, G, and H



TABLE 7-8. DIGEST OF CONDITIONS AND RECOMMENDED PRACTICE IN PRIMARY CEMENTING (SMITH, 1976)

	Conductor Pipe	Surface Pipe	Intermediate and/or Production String
Casing size, in.	20 to 30	7 to 20	4 1/2 to 11 3/4
Setting depth, ft.	30 to 1,500	40 to 4,500	1,000 to 15,000
Well conditions	Probably enlarged	Probably enlarged	Probably enlarged (particularly in salt)
Fluid	Native	Native	Native or water-base
Fluid properties	Viscous, thick cake	Viscous, thick cake	Controlled viscosity and controlled fluid loss
Cement pumped to	Surface	Surface	Surface pipe or lower, depending on conditions
Cement, API Class	A, G, H	A, G, H	A, C, G, H
Additives normally used with cement	2 to 3 percent CaCl	Bentonite or pozzolan	High gel, filter, or pozzolan bentonite; dispersant + retarder if needed; salt, for cementing through salt sections
Fill-in slurry	Like initial slurry, densified (ready-mix concrete may be dumped into annulus)	Densified for high strength (deep well may use high-strength slurry for entire job)	Densified for high strength over lower 500 to 1,000 ft
Technique	Through drillpipe using small plugs and sealing sleeve, or down casing with large plugs, or into annulus; float collar may or may not be used.	Same as for conductor pipe Centralize lower casing	Down casing with plugs (top and bottom), or in stages, depending on fracture gradient. If string is very heavy, it may be set on bottom and cemented through ports. Use float collar and guide shoe; centralize in critical areas.
Placement time	Generally less than 30 min.	Generally less than 45 min.	Variable, depending on cement volume--45 min. to 2 1/2 hrs

(Continued)

TABLE 7-8. Continued

	Conductor Pipe	Surface Pipe	Intermediate and/or Production String
Placement rate	Low or high	High	High
WOC time	6 to 8 hours, depending on regulations	6 to 12 hours, depending on regulations	6 to 12 hours, depending on regulations
Mud/Cement spacers	Plugs and water flush	Plugs and water or thin cement	Plugs and thin cement, or spacer compatible with mud
Cementing hazards	Casing can be pumped out of hole; cement may fall back down the hole after it has been circulated to surface.	Same as for conductor. Lower joints may be lost down the hole with deeper drilling; casing can easily stick.	There may be both weak and high-pressure zones, requiring variable-weight cement slurries. Prolonged drilling may damage casing. Wells may be hot, necessitating measurement of bottom-hole temperatures.

use of a granular material having sufficient strength to form a bridge across the void. These effects are well illustrated by the work of Howard and Scott (1951). In their experiments, mud containing various concentrations and types of lost circulation materials was circulated through different sizes of slots or simulated fractures. The slots were considered sealed when the plugging materials withstood 1000 psi differential across the fracture. The main conclusions of this study were:

1. Granular bridging materials are the most effective lost circulation agent in fractured rocks.
2. Concentrations of 20 lb/bbl gave maximum results and little increase in plugging will result from higher concentrations.

The materials evaluated and the maximum size fractures sealed by each are shown in Figure 7-7.

#### Hole Sloughing and Enlargement --

Hole sloughing and enlargement are problems generally associated with shale. Some areas are characterized by shale sections containing bentonite or other hydratable clays which continually adsorb water, swell, and slough into the hole. Such beds are referred to as heaving shales and constitute a severe drilling hazard when encountered. Pipe sticking, excessive solid buildup in the mud, and hole bridging are typical resultant problems. Various treatments are sometimes successful, such as (Gatlin, 1960):

1. Changing mud system to inhibitive (high calcium content) type such as lime or gypsum which reduces tendency of the mud to hydrate water-sensitive clays.
2. Increasing circulation rate for more rapid removal of particles.
3. Increasing mud density for greater wall support.
4. Decreasing water loss of mud.
5. Changing to oil-emulsion mud.
6. Changing to oil-base mud.

Moore (1974) cites the addition of Chrome Lignosulfonate to drilling muds and the use of potassium chloride-polymer muds as relatively recent developments in the control of sloughing shales.

Hole enlargement can also be a problem in areas where soluble evaporites, such as salt, are present in the geologic section. Hole enlargement increases the required volumes of drilling mud and casing cement and may make it difficult to obtain a good cementing job. The principal means of avoiding hole enlargement in an area of salt occurrence is the use of salt-saturated mud.

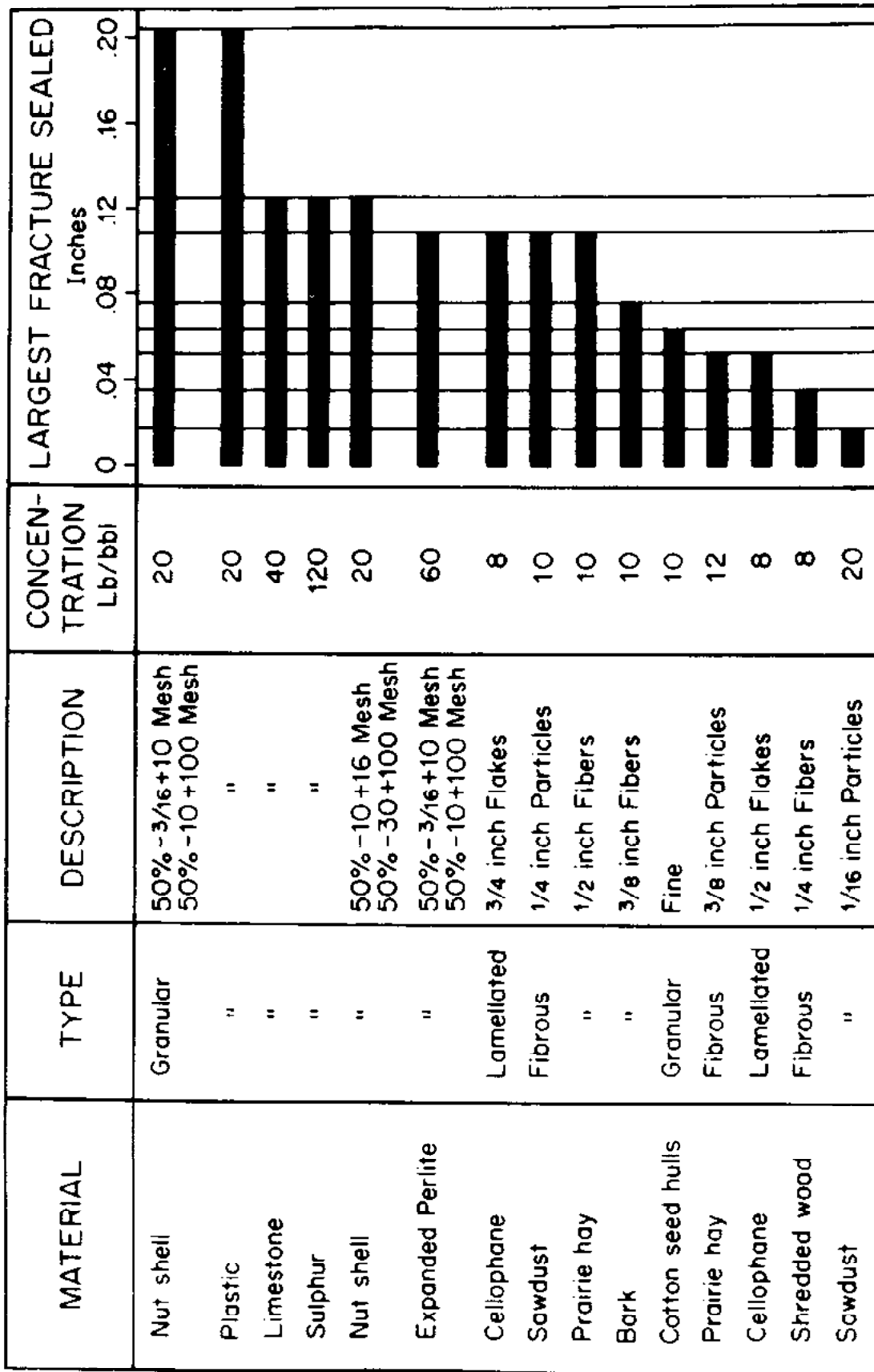

FIGURE 7-7. SUMMARY OF RESULTS OF TESTS OF LOST CIRCULATION MATERIALS (HOWARD AND SCOTT, 1951).

## Pipe Sticking --

The drill string may become stuck in the hole during drilling for a variety of reasons. Gatlin (1960) lists some of the causes of stuck pipe as:

1. Foreign objects or so called "junk" in the hole.
2. Sloughing formations (see above).
3. Cuttings settling above the drill bit or drill collars.
4. Bit and drill collar balling.
5. Key seating.
6. Pressure-differential sticking.

The first four of these are self-explanatory.

Key seating occurs when drilling below a dog-leg in a hole. The drill pipe presses against the hole, wearing a groove in it. On coming out of the hole, the drill collars may jam in this groove or seat and become stuck.

Pressure-differential sticking is caused by the greater pressure in the mud column literally gluing drill pipe to the borehole wall adjacent to a permeable formation.

Moore (1974) and Gatlin (1960) discuss methods of preventing pipe sticking and dealing with stuck pipe.

## Casing Installation

Prior to installation of casing, the borehole must be conditioned to prepare it for cementing. Conditioning is accomplished by circulating mud to clean the borehole. If the hole has been sitting open for a long period during logging and testing, it is also good practice to make a clean-up run with the drilling string before running casing.

After conditioning the hole, casing is "run" into the hole and then cemented, as discussed in the next section.

## CEMENTING

Primary cementing of deep wells is the process of mixing a slurry of cement and water and pumping it down, usually through casing, into the open hole below the casing. The cement is then forced upward, under pressure, into the annulus between the casing and the borehole or between the casing and previously installed larger casing (Figure 7-8). Although cement is normally emplaced through the casing, several other methods are available for special situations, as shown in Figure 7-9.

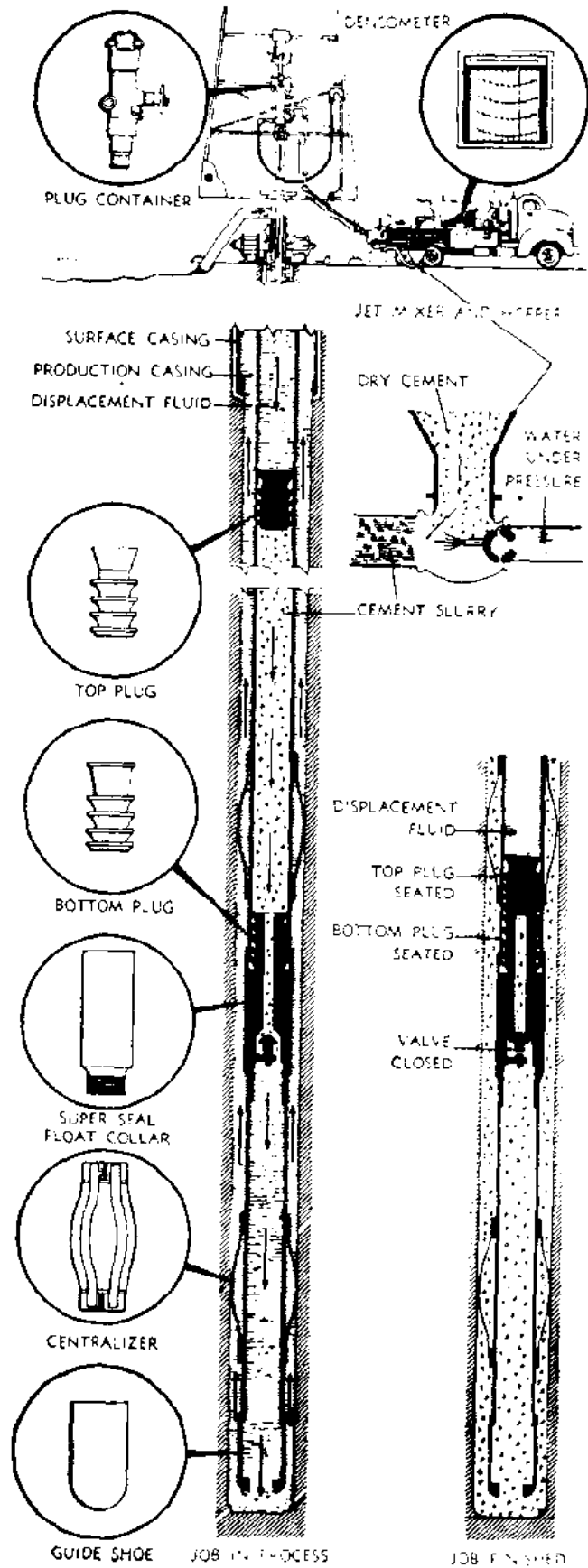

FIGURE 7-8. TYPICAL PRIMARY CEMENTING JOB.  
(SMITH, 1976).

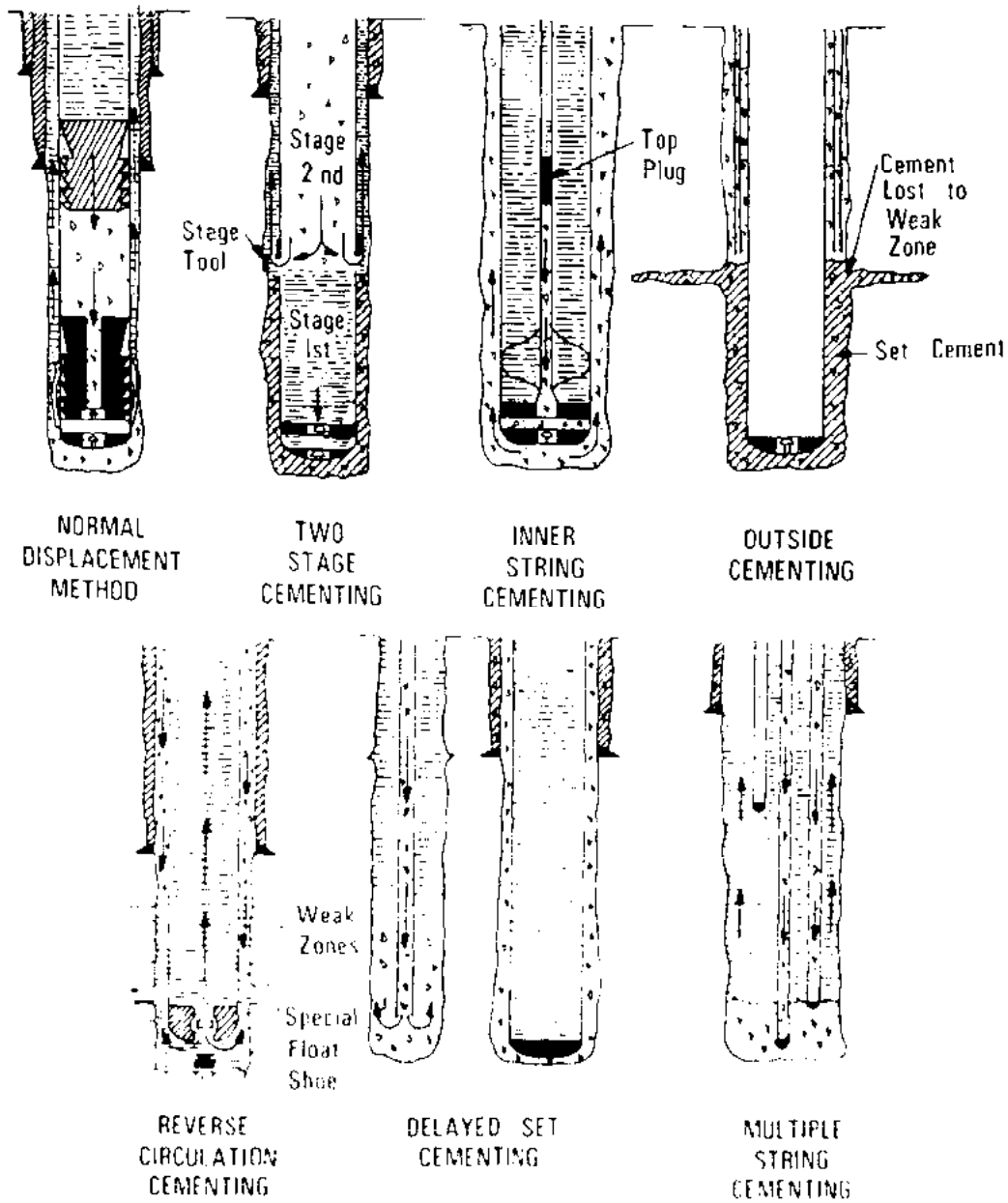

FIGURE 7-9. METHODS OF EMPLACING CEMENT DURING PRIMARY CEMENTING (SMITH, 1976).

The two principal functions of primary cementing are to restrict fluid movement between formations and to bond and support the casing. Cement also aids in protecting the casing from external corrosion and isolates high pressure or lost circulation zones. Another type of cementing procedure, squeeze cementing, is used to correct defective primary cementing jobs. In squeeze cementing, cement is selectively placed to fill intervals not completely cemented during primary cementing. Squeeze cementing can also be for other purposes, such as selective plugging of an injection interval without abandonment of the entire well.

A comprehensive monograph concerning well cementing has recently been published by the Society of Petroleum Engineers (Smith, 1976). Much of the material in this section is drawn from that publication.

### Cements and Cement Additives

Oilwell cements are classified by the American Petroleum Institute (1975-a) into eight categories (A to H) according to their suitability for use at various depths and temperatures and according to other characteristics as described below:

Class A: Intended for use from surface to a depth of 6,000 feet when special properties are not required. Available only in Ordinary type (similar to ASTM C150, Type I).

Class B: Intended for use from surface to a depth of 6,000 feet when conditions require moderate to high sulfate resistance. Available in both Moderate (similar to ASTM C150, Type II) and High Sulfate Resistant types.

Class C: Intended for use from surface to a depth of 6,000 feet when conditions require high early strength. Available in Ordinary type and in Moderate and High Sulfate Resistant types.

Class D: Intended for use at depths from 6,000 to 10,000 feet and at moderately high temperatures and pressures. Available in both Moderate and High Sulfate Resistant types.

Class E: Intended for use at depths from 10,000 to 14,000 feet and at high temperatures and pressures. Available in both Moderate and High Sulfate Resistant type.

Class F: Intended for use at depths from 10,000 to 16,000 feet and at extremely high temperatures and pressures. Available in High Sulfate Resistant type.



Class G: Intended for use as a basic cement from surface to a depth of 8,000 feet as manufactured. With accelerators and retarders it can be used at a wide range of depths and temperatures. It is specified that no addition except calcium sulfate or water, or both, shall be interground or blended with the clinker during the manufacture of Class G cement. It is available in Moderate and High Sulfate Resistant types.

Class H: Intended for use as a basic cement from surface to a depth of 8,000 feet as manufactured. This cement can be used with accelerators and retarders at a wide range of depths and temperatures. It is specified that no additions except calcium sulfate or water, or both, shall be interground or blended with the clinker during the manufacture of Class H cement. Available only in Moderate Sulfate Resistant type.

In addition to the cements listed above, there are a number of cementing materials with special characteristics for which API standards do not exist. Their uniformity and quality are controlled by the supplier. These materials include (Smith, 1976):

1. pozzolanic-portland cements
2. pozzolan-lime cements
3. resin or plastic cements
4. gypsum cements
5. diesel oil cements
6. expanding cements
7. refractory cements
8. latex cement
9. cement for permafrost environments

Several of these special cements have properties that make them of particular interest in wastewater injection well cementing. Resin and plastic cements are particularly chemically resistant and are recommended for cementing the bottom of injection casing, where injected chemicals are in contact with the cement (Barlow, 1972; Smith, 1976). Expanding cements have been recommended for injection wells because of the particularly tight seal they can form against the casing and borehole.

According to Smith (1976), more than 40 additives are in use to provide optimum cement slurry characteristics for any downhole condition. Cement additives are classified as:

1. Accelerators
2. Light-weight additives
3. Heavy-weight additives
4. Retarders
5. Lost-circulation-control agents
6. Filtration-control agents
7. Friction reducers
8. Specialty materials

Table 7-7 summarizes the most common additives, their uses and benefits, and the cements to which they can be added.

#### Primary Cementing

A successful primary cementing job is considered to be as important as any aspect of injection well construction. A poor cement job can allow migration of wastewater in voids between injection casing and the borehole. In some cases freshwater-bearing formations could even be endangered, but perhaps the greatest danger is from external corrosion of injection casing that can lead to loss of the well. Smith (1976) discusses primary cementing in detail; the most important points of which are summarized in Table 7-8. The information in Table 7-8 is directed toward oilfield operations and this must be considered when applying the recommendations to injection wells.

In injection well operations, the primary cement job should always be checked. Methods of checking include temperature surveys, cement bond logs, and radioactive tracer surveys. Temperature surveys and radioactive tracer surveys are used for locating the top of cement behind casing. Cement bond logs are used to indicate how successfully the cement has been placed behind the casing. These logs are discussed further in Chapters 3 and 9.

It should be noted that the drilling and cementing of wells is regulated in many states. Such aspects of casing and cementing are regulated as:

1. The method of setting casing
2. The volume of cement emplaced
3. The time that cement must be allowed to harden (waiting on cement time - WOC time) before drilling resumes or the well is completed.

#### 4. The testing of cement jobs.

Many of the applicable laws and regulations are summarized by the American Petroleum Institute (1975-b).

##### Casing Equipment

Casing design has been discussed earlier in this chapter. Supplementary equipment that is used with casing to assist in its emplacement and cementing includes flotation equipment, cementing plugs, stage tools, cementing baskets, centralizers, and scratchers. Of these items, casing centralizers and scratchers are of particular interest here because of their importance in obtaining a good cement job.

Casing centralizers are, as their name implies, used to center a casing string in the borehole. Types of casing centralizers are shown in Figure 7-10. Because the success of a primary cement job hinges on the proper centralization of casing (Smith, 1976), centralizers are essential in injection well construction. The American Petroleum Institute (1973) has published specifications on the proper placement of centralizers. Recommendations for the use of centralizers is also available from oilfield supply companies.

Casing scratchers or wall cleaners are devices that attach to the outside of casing to remove loose drilling-mud cake from the wellbore so that the cement can bond to the formation. Scratchers also, like centralizers, help to distribute the cement uniformly around the casing. Scratchers are classed as either rotating or reciprocating types, depending on whether they are used as the casing is either rotated or worked up and down. Examples of the two types are shown in Figure 7-11. Reciprocating scratchers can be used in any well, but rotating scratchers are subject to damage in wells where casing cannot be freely rotated, such as deviated holes.

##### CASING LANDING

Landing of casing is the transfer of its weight to the well head or casing hanger after cementing.

An American Petroleum Institute Committee on Casing Landing Practices (1955-b) reviewed the records of 3700 wells ranging in depth from 2,000 to 14,000 feet. The casing strings in these wells were landed by one of the four following methods:

1. Landing as cemented
2. Landing in tension at the freeze point (top of cement)
3. Unstressed landing at the freeze point
4. Landing in compression at the freeze point

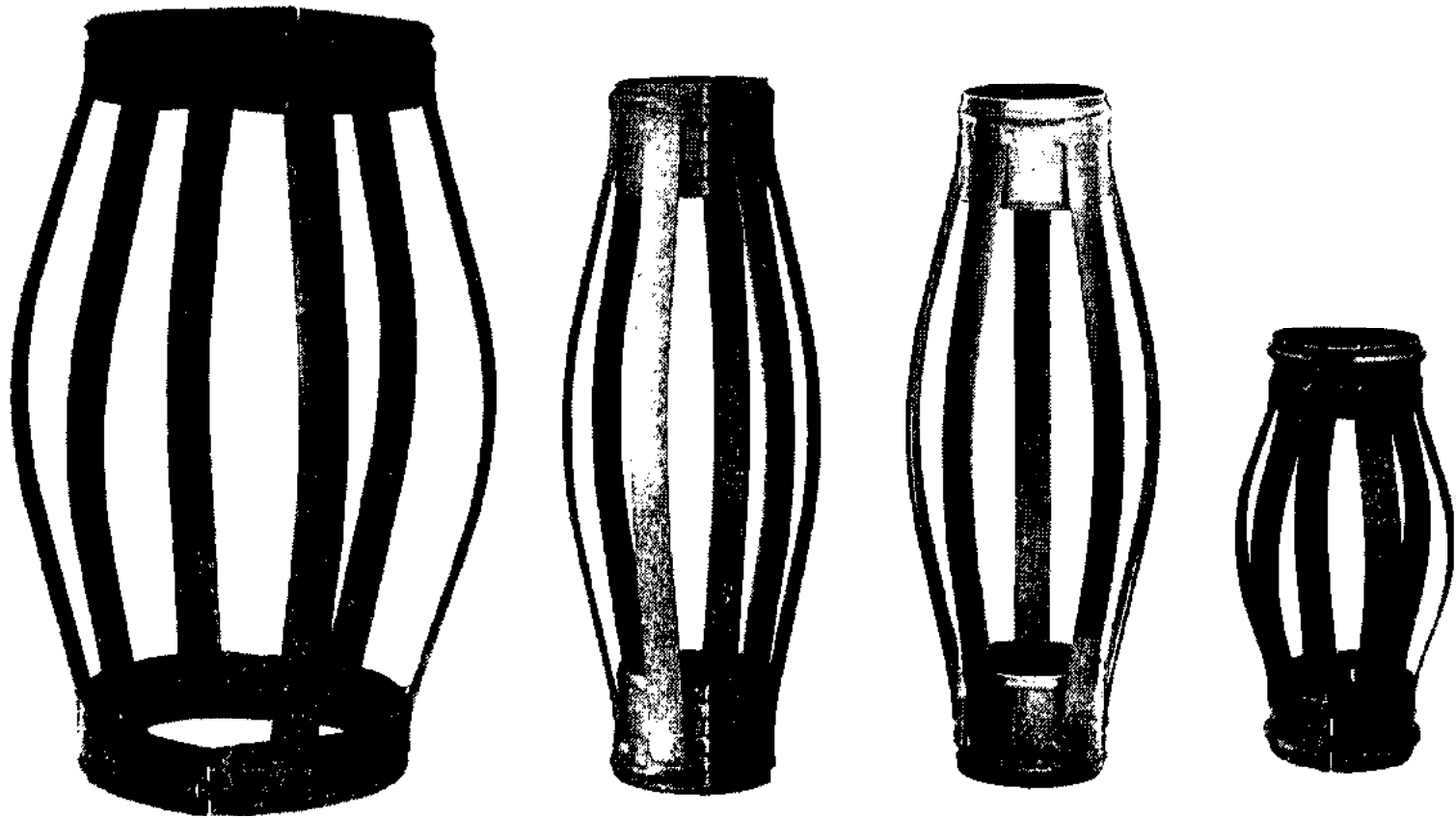

FIGURE 7-10. TYPES OF CASING CENTRALIZERS (SMITH, 1976).

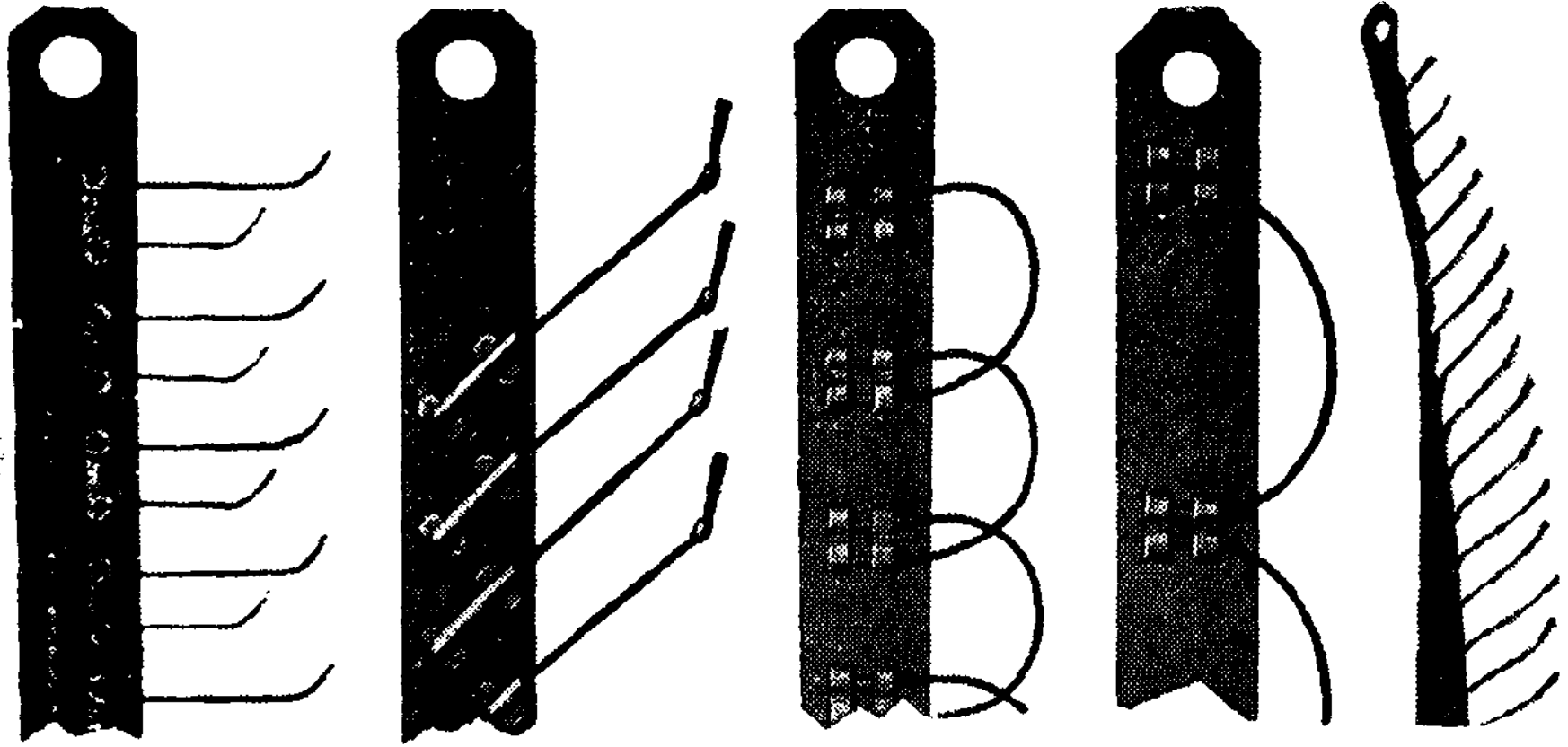
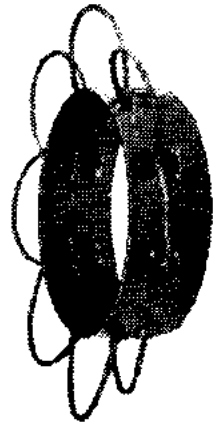
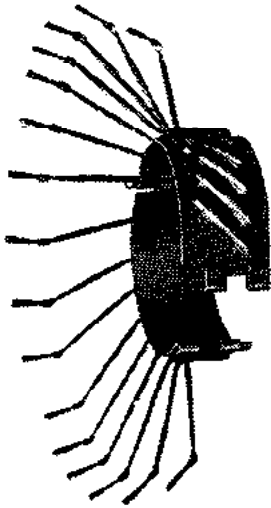
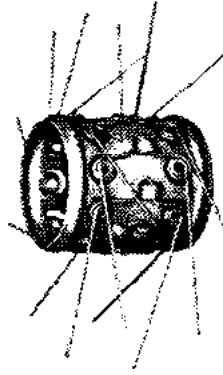
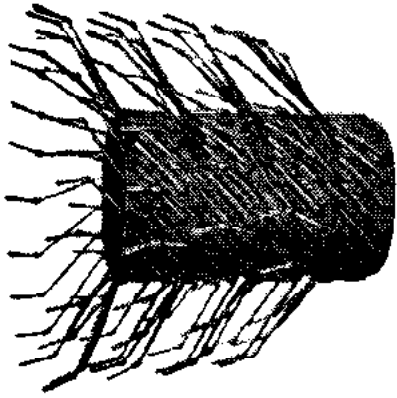

FIGURE 7-11. TYPES OF SCRATCHERS: a. ROTATING, b. RECIPROCATING



Based on the committee's review, it was recommended that casing be landed as cemented in all but exceptional cases. That is, the weight of the casing be supported at the wellhead, just as it was prior to cementing.

## WELL STIMULATION

The term stimulation is used in the petroleum industry to include treatment methods applied to a well bore and to the immediately adjacent rock reservoir to improve the flow characteristics of the well and the reservoir. Stimulation methods may be mechanical or chemical or a combination of both. Terms comparable to stimulation, as used by the water-well industry, are development, redevelopment, rehabilitation, and reconditioning. In this chapter, the discussion of stimulation focuses on well development methods applied during well construction. Redevelopment, rehabilitation, and reconditioning techniques are used to improve the performance of operating wells that have suffered loss of efficiency.

Koenig (1960) performed a systematic review of stimulation methods used in the petroleum and water-well drilling industries and grouped them into five major categories. His categories are: surging, shooting, vibratory explosion, pressure acidizing, and hydraulic fracturing. Koenig's (1960) order of listing supposedly was from the most familiar to the less familiar. The listing may very well reflect the order of familiarity of the methods to workers in the water-well industry, but acidizing and hydraulic fracturing are by far the most widely used stimulation methods in the petroleum industry today. Gatlin (1960) classifies acidizing, hydraulic fracturing, and nitro-shooting as large-area penetrating methods. That is, they can increase formation permeability for a considerable distance away from the well bore. Gatlin (1960) classifies perforating, mud-acid washing, jet acidization, and detergent washing as skin-breaking methods. Skin-breaking techniques are used to remove drilling mud or other deposits from the formation face or to improve permeability within a few inches of the formation face in the zone where drilling mud infiltration or other damage may have occurred.

### Acidizing

Acidizing involves the injection of acid into an acid-soluble reservoir rock where its dissolving action enlarges existing voids and thereby increases the permeability of the reservoir. The acid most commonly used is 15 percent hydrochloric acid, which reacts with limestone and dolomite. Hydrochloric acid does not dissolve noncarbonate minerals, such as the silicates in sandstone reservoirs, but some sandstones contain sufficient calcite or dolomite so that acidizing is useful. Numerous additives are used along with the hydrochloric acid for particular reasons. Inhibitors are often used to retard corrosion of tubing and casing during acid injection. Hydrofluoric acid is commonly combined with hydrochloric acid to form a mud acid. The mud acid is so named because the hydrofluoric acid reacts with the silicate minerals present in drilling muds. Mud acid may be used in small volumes to prepare a well for a larger conventional acid treatment or it may be the only treatment used.

## Hydraulic Fracturing

Hydraulic fracturing was first introduced to the petroleum industry in 1948 (Clark, 1949). The basic procedure, which is described in detail in Chapter 3, is the injection of a fracturing fluid into the reservoir zone under sufficient pressure to open existing fractures and create new ones. Because the fractures tend to close when the pressure is allowed to return to normal, propping agents are injected with the fluid to keep the fractures open. Silica sand of a carefully selected size is a common propping agent. Various fluids are used for fracturing, including acid, as described above. The treatment is then referred to as acid-fracturing.

Hydraulic fracturing is a controversial stimulation procedure to some because it is thought that there may be a danger of opening fractures across confining beds as well as within the injection interval itself. There would be little concern about fracturing of confining beds where thousands of feet of confinement exists and where the fracture treatment is of limited scope. On the other hand, an extensive fracture program in an injection interval overlain by thin confining beds would probably be unwise. It is universally considered that continuous injection of the wastewater at pressures above the fracturing level is poor practice.

## Other Stimulation Methods

The third large-area stimulation method listed above is nitro-shooting. The use of explosives to shatter the rock adjacent to the borehole is practically as old as the oil industry. However, stimulation with explosives is little used today, as it has been almost entirely replaced by hydraulic fracturing and perforating, which is described earlier in this chapter.

Mud-acid washing is treatment of the borehole wall with mud acid, as described above, to reduce formation damage from coating and invasion of drilling mud. A high velocity jet may be used to obtain a more effective result, in which case the treatment is jet acidization. Jetting is also performed without acid.

Chemicals other than acid are also used for stimulation. Surface active agents, for example, have been found useful in removing flow restrictions resulting from emulsions and/or swelling of clays (Gatlin, 1960).

Campbell and Lehr (1973) provide a well-referenced summary of petroleum and water-well industry stimulation technology.

## COMPLETION REPORTS

The preparation of a well-completion report is considered to be an essential step in the proper engineering and regulatory processes. Well completion reports describe in detail all aspects of the drilling, logging, casing, cementing, stimulation, and initial testing of a well. This information is necessary for the regulatory agency to determine whether or not wastewater injection should be allowed. It also provides the well operator and the regulatory agency with a record of the well as a basis for interpreting the



cause of any operational difficulties that may arise and for making future engineering decisions. The Ohio River Valley Water Sanitation Commission (1973) provides an example of a well completion report form.

#### DESIGN EXAMPLES

Numerous examples of injection well design appear in the literature, including those given by Baffa, 1969; Barraclough, 1966; Batz, 1964; Bayazeed, 1971; Bergstrom, 1968; Black, Crow and Eidsness, 1972; Brown and Spalding, 1966; Davis and Funk, 1974; Dean, 1965; DeRopp, 1951; DeWitt, 1960; Donaldson, 1972; Foster, 1972; Goolsby, 1971; Hartman, 1966, 1968; Herndon, 1970; Hundley and Matulis, 1962; Klotzman and Veir, 1966; Leenheer and Malcolm, 1973; Luff, 1960; Lynn and Arlin, 1962; MacLeod, 1961; McChem and Garnet, 1967; Ostroot and Donaldson, 1970; Paradiso, 1956; Talbot, 1968; Tucker and Kidd, 1973; Veir, 1967; and Warner, 1972. A comprehensive and well-indexed annotated bibliography has been published by the U. S. Geological Survey covering the period prior to 1971 (Rima, et. al., 1971).

## REFERENCES

### CHAPTER 7

- American Petroleum Institute. "Specification for Casing, Tubing, and Drill Pipe. 33rd edition. API Std. 5A. Dallas, Texas. 1975.
- American Petroleum Institute. "Specifications for Oil-Well Cements and Cement Additives." API Standard 10A. Amer. Petroleum Institute. Dallas, Texas. 1975-a.
- American Petroleum Institute. "Environmental Protection Laws and Regulations Related to Exploration, Drilling, Production, and Gas Processing Plant Operations." API Bulletin D18. API, Dallas, Texas. March, 1975-b.
- American Petroleum Institute. "Casing Centralizers." API Specification 10D. API, Dallas, Texas. 2nd ed. February, 1973.
- American Petroleum Institute. Problems in the Disposal of Radioactive Waste in Deep Wells. A Report Prepared by the Subcommittee on Disposal of Radioactive Waste. API, Dallas, Texas. October, 1958.
- American Petroleum Institute. Selection and Evaluation of Well-Completion Methods. API Bull. D6, Division of Production, Dallas, Texas. 1955.
- American Petroleum Institute. Survey Report on Casing-String Design Factors. API, Dallas, Texas. 1955-a.
- American Petroleum Institute. "Casing Landing Recommendations." API Bulletin D7. Dallas, Texas. 1955-b.
- Baffa, J. L. "Injection Well Experience at Riverhead, New York." Journal American Water Well Association. January, 1969. pp. 41-46.
- Barlow, A. C. "Basic Disposal-Well Design." in Underground Waste Management and Environmental Implications. T. D. Cook, ed. Amer. Assoc. Petroleum Geologists Memoir 18, AAPG, Tulsa, Oklahoma. 1972. pp. 72-76.
- Barraclough, J. T. "Waste Injection Into a Deep Limestone in Northwest Florida." Ground Water. Vol. 4, No. 1. 1966. pp. 22-24.
- Batz, M. E. "Deep Well Disposal of Nylon Waste Water." Chemical Engineering Progress. Vol. 60, No. 10. 1964. pp. 85-88.

- Bayazeed, A. F., and Donaldson, E. C. "Deep-Well Disposal of Steel Pickling Acid." presented at 46th Annual Fall Meeting of the Soc. of Pet. Eng. of AIME, New Orleans, La., Oct. 3-6. Paper No. SPE 3615. 1971. 5 pp.
- Bergstrom, R. E. "Feasibility of Subsurface Disposal of Industrial Wastes in Illinois." Illinois Geological Survey Circular 426. 1968. 18 pp.
- Black, Crow & Eidsness, Inc. Engineering Report on Modification to Deep-Well Disposal System. Effect of Monitoring Wells and Future Monitoring Requirements for Sugar Cane Growers Coop. of Florida, Belle Glade, Palm Beach County, Florida. Engr. Report Project No. 387-71-01. 40 pp.
- Blum, H. "Casing Program." Fundamentals of Rotary Drilling. The Petroleum Engineering Publishing Company, Dallas, Texas. 1959.
- Brown, R. W., and Spalding, C. W. "Deep Well Disposal of Spent Hardwood Pulping Liquors." Water Pollution Control Federation. June, Vol. 38, No. 12. 1966. pp. 1916-1925.
- Buzarde, L. E., Kastor, R. L., Bell, W. T., and DePriester, C. L. Production Operations Course I - Well Completions. Society of Petroleum Engineers. 1972. pp. 66-109.
- Campbell, M. D., and Lehr, J. H. Water Well Technology. McGraw-Hill Book Company, New York. 1973. 681 pp.
- Clark, J. B. "A Hydraulic Process for Increasing the Productivity of Wells." Transactions Am. Inst. of Mining Engineers. Vol. 186. 1949. pp. 1-8.
- Craft, Holden, & Graves. Well Design: Drilling and Production. Prentice-Hall, Inc., Englewood Cliffs, New Jersey. 1962. pp. 101-157.
- Davis, K. E., and Funk, R. J. "Control of Unconsolidated Sands in Waste-Disposal Wells." in Underground Waste Management and Environmental Implications. T. D. Cook, ed. Am. Assoc. Petroleum Geologists Memoir 18. A.A.P.G., Tulsa, Oklahoma. 1972. pp. 112-118.
- Dean, B. T. "Design and Operation of a Deep Well Disposal System." Water Pollution Control Federation Journal. Vol. 37, No. 2. 1965. pp. 245-254.
- DeRopp, H. W. "Chemical Waste Disposal at Victoria, Texas. Plant of the DuPont Company," Sewage and Industrial Wastes. Vol. 23, No. 2. 1951. pp. 194-197.
- DeWitt, W. Geology of the Michigan Basin with Reference to Subsurface Disposal of Radioactive Waste. Atomic Energy Commission Report TFI-771. 1960. 100 pp.
- Donaldson, E. C. "Deep Well Disposal of Liquid Mine Waste." U. S. Bureau of Mines I. C. 70. pp. 39-65.

- Foster, J. B., and Goolsby, D. A. "Construction of Waste-Injection Monitor Wells Near Pensacola, Florida." Florida Bureau Geologic Information Circular, No. 74. 1972. pp. 34.
- Gatlin, Carl. Petroleum Engineering, Drilling and Well Completions. Prentice Hall, Inc., Englewood Cliffs, N. J. 1960. 341 pp.
- Goolsby, D. A. "Hydrogeochemical Effects of Injecting Wastes into a Limestone Aquifer Near Pensacola, Florida." Ground Water. Vol. 9, No. 1. 1971. pp. 13-19.
- Halliburton. Handbook of Applied Rheology Section One, Newtonian Fluids. Halliburton Company, Duncan, Oklahoma. 1963.
- Hartman, C. D. "Deep Well Disposal at Midwest Steel." Iron and Steel Engineering. No. 12. 1966. pp. 118-121.
- Hartman, C. D. "Deep Well Disposal of Steel-Mill Wastes." Journal Poll. Control Fed. Vol. 40, No. 1. January, 1968. pp. 95-100.
- Herndon, J. "Deep-Well Disposal - Prerequisites, Priorities and Practices" presented at 17th Annual Southwestern Petroleum Short Course, Texas Tech University, Lubbock, Texas, April 16-17, 1970. 1970. 17 pp.
- Howard, G. C., and Scott, P. O. "An Analysis and the Control of Lost Circulation." Petroleum Transactions. Am. Institute of Mining Engineers. Vol. 192. 1951. pp. 171-182.
- Hundley, C. L., and Matulis, J. T. "Deep Well Disposal of Industrial Waste by FMC Corp." Indust. Water and Waste. September-October, 1962. pp. 128-131.
- Klotzman, M., and Veir, B. "Celanese Chemical Pumps Wastes Into Disposal Wells," Oil and Gas Journal. Vol. 64, No. 15. 1966. pp. 84-87.
- Koenig, Louis. "Survey and Analysis of Well Stimulation and Performance." Journal Am. Water Works Assoc. Vol. 52, No. 3. March 1960. pp. 333-350.
- Leenheer, J. A., and Malcolm, R. L. "Case History of Subsurface Waste Injection of an Industrial Organic Waste." AAPG Gulsu, Oklahoma. 1973. pp. 565-584.
- Long, J. T. Engineering for Nuclear Fuel Reprocessing. Gordon and Breach Science Pub., Inc., New York. 1967.
- Luff, G. S. "Underground Waste Disposal for American Airlines, Inc." 11th Oklahoma Industrial Waste Conference Proceedings. Oklahoma State University, Stillwater, Oklahoma. 1960. pp. 71-80.

- Lynn, R. D., and Arlin, Z. E. "Anaconda Successfully Disposes of Uranium Mill Waste Water by Deep Well Injection." Mining Engineering. Vol. 14, No. 7. July, 1962. pp. 49-52.
- MacLeod, I. C. "Disposal of Spent Caustic and Phenolic Water in Deep Wells." 8th Ontario Industrial Waste Conference Proc. 1961. pp. 49-58.
- Mecham, O. E., and Garret, J. H. "Deep Injection Disposal Well for Liquid Toxic Wastes." American Society Civil Engineers Proceedings. Journal. Construction Div. 1963. pp. 111-121.
- Moore, P. L. Drilling Practices Manual. The Petroleum Publishing Company, Tulsa, Oklahoma. 1974. 447 pp.
- Ohio River Valley Water Sanitation Commission. Underground Injection of Wastewaters in the Ohio Valley Region. ORSANCO, Cincinnati, Ohio. 1973. 63 pp.
- Ostroot, G. W., and Donaldson, A. L. "Subsurface Disposal of Acidic Effluents." presented at 1970 Evangeline Section Regional Meeting of the Society of Petroleum Engineers of AIME, Lafayette, La., Nov. 9-10, 1970. Paper No. SPE 3201. 1970. 6 pp.
- Paradiso, S. J. "Disposal of Fine Chemical Wastes." in Industrial Waste Conference No. 10, 1955 Proceedings. Purdue University, Engineering Extension Service 89. 1956. pp. 49-60.
- Petroleum Extension Service. Twelve Issue Training Series on Petroleum Exploration and Development. Published in cooperation with the University of Texas at Austin and the International Association of Drilling Contractors 1971-present.
- Rima, Donald R., Chase, Edith B., and Myers, Beverly. "Subsurface Waste Disposal by Means of Wells--a Selective Annotated Bibliography." U. S. Geological Survey Water Supply Paper 2020. U. S. Gov't. Printing Office, Washington, D. C. 1971. 305 pp.
- Smith, D. K. "Cementing." Society of Petroleum Engineers Monograph Volume 4. Society of Petroleum Engineers of AIME, New York. 1976.
- Talbot, J. S. "Some Basic Factors in the Consideration and Installation of Deep Well Disposal Systems." W & S W. 1968. pp. R-213-R-219.
- Trevorrow, L. E., Warner, D. L., and Steindler, M. J. Considerations Affecting Deep-Well Disposal of Tritium-Bearing Low-Level Aqueous Waste from Nuclear Fuel Reprocessing Plants. ANL-76-76. Argonne National Laboratory, Argonne, Illinois. March, 1977. 190 pp.
- Tusler, W. E., and Kidd, H. F. Deep Well Disposal in Alabama. Geological Survey of Alabama. Bulletin 104, University of Alabama. 1973. 230 pp.
- Wick, R. H. "Belgian Deep Well Disposal Practices." Proceedings 11th Industrial Water and Waste Conference. Proc. of Soc. June 1-2, 1967. pp. 111-125.

Warner, D. L. Deep-Well Injection of Liquid Waste. U. S. Dept. of Health, Education, and Welfare, Public Health Service Publication No. 99-WP-21, 1965. 55 pp.

Warner, D. L. Survey of Industrial Waste Injection Wells. Vols. I and II. U.S.G.S. Contract 14-01-0001-12280 (NTIS #AD-756-641). June, 1972.

## CHAPTER 8

### PRE-INJECTION PREPARATION AND START-UP OPERATIONS

The period between the completion of injection well construction and initiation of full-scale operation affords an excellent opportunity to undertake several very important tasks. The well operator may run several types of logs and final tests to obtain the data needed to establish the baseline characteristics of the well. The operator can also use this time to instruct his or her supervisory and operating personnel in all aspects of injection well operation, as well as in proper procedures for dealing with both common problems and emergencies. Finally, the well operator should also, at this time, obtain any necessary authorization from state and federal regulatory agencies. Only after he or she has done all this can the operator be ready for full-scale injection operations.

#### PRE-INJECTION TESTING

After the well is cased but before injection operations start, there is an opportunity for extensive testing of the proposed reservoir and of the mechanical elements of the well itself. The data thus derived will serve to identify problems in the condition of the well and in the injection interval, and to provide baseline information on injection interval performance. During such testing, minor quantities of treated wastewater may be injected to confirm the chemical compatibility of reservoir water and wastewater. Tracers may be injected and monitored, and temperature and flow meter logs may be run to define the zones into which injected fluids are initially entering. The selection of these tests depends largely on the circumstances surrounding each project.

#### Injectivity Testing

Initial pumping and/or injection tests for defining reservoir characteristics are discussed in Chapter 3, and the advantages and disadvantages of the two practices outlined. Eventually, injection testing will be needed, and some testing is usually carried out before final well completion; then, if necessary, the well may be stimulated to improve its capacity to accept injected wastewater. Final injection testing is performed prior to full-scale operation to define the baseline characteristics of the well and of the injection interval. The water used for injection testing may be water extracted during pumping of the injection interval, treated surface or ground water, or treated wastewater. The choice of the water to be used for testing will depend on the particular site conditions and also on regulatory constraints. In cases where the injection interval is known to be or is suspected of being water-sensitive, as discussed in Chapter 5, the use of water pumped from the

injection interval should minimize the potential clay mineral reaction. However, the collected formation water should be monitored chemically during storage to insure that chemical changes do not occur between the time the water is withdrawn from the formation to be injected and the time it is used in the testing operations. Some chemical stabilization may be required.

Where the injection interval is not water-sensitive, i. e., where it does not contain reactive clays, treated surface water or ground water from a production well can be used for testing. Such water is often used when it is desirable to place a buffer of nonreactive water between the formation water and the injected wastewater.

Treated wastewater can also be used for testing and often is. However, some state regulatory agencies may prohibit injection of any wastewater until after final testing, the results of which are used to determine whether an operating permit will be issued.

Injection tests are usually run in one of two ways. One method is termed step testing, in which injection is initiated at a low rate, and that rate is maintained until the injection pressure has stabilized. The rate is then increased in steps, each new rate being maintained for the same time interval as the first, until the maximum desired rate is finally reached. Well-head pressure is continuously monitored during the entire injection period and after injection has ceased, until the well-head pressure has declined to zero. It is advantageous to monitor bottom-hole pressure as well, since this gives a direct measure of pressure losses in the well. Otherwise, only calculated values can be obtained for these losses. Steady rate tests are also used, in which injection is held at a constant rate until the injection pressure is nearly constant. Injection is then stopped, and the pressure is monitored until it declines to zero. Such a test may be run at only one rate, the planned operating rate, or it may be repeated for several rates. Either type of test is satisfactory for injectivity analysis. The step-injection test is more efficient but the steady-rate test is more easily and reliably analyzed. Quantitative analysis of injectivity tests is presented in Chapter 4.

### Logging Techniques

A variety of logging methods are available, as discussed in Chapters 4 and 9, for determining the characteristics of the well and of the injection interval after well construction but prior to initiation of full-scale injection.

Three types of logs that are discussed in Chapter 9 are particularly useful for defining the zones that will receive the injected water; these are the flow meter log, radioactive tracer injectivity log, and the temperature log. When combined with injectivity tests, these tools can indicate the presence of formation damage resulting from drilling mud invasion or other causes. When formation damage is suspected, the well can be stimulated and the results checked by running the logs again.



## Baseline Data

After the tests described above and the last stages of clean-up of the injection interval are completed, the final "baseline" data can be obtained. Final bottom-hole temperature and static pressure should be recorded after all clean-up operations have been completed, but before full-scale injection of the wastewater stream. The start-up process should be of low volume, with all data collected as often as is practical. Data obtained during this period are critical to the well's future. Should any abrupt or unexpected variation in operating characteristics occur, the injection start-up should be curtailed immediately to allow for an investigation to establish the probable cause of variation and indicated procedures for renewed start-up.

## OPERATING PROGRAM

The operating program for an injection system should be adopted to the geological and engineering properties of the injection interval and to the volume and chemistry of the waste fluids (ORSANDO, 1973). The geological and engineering properties of the injection interval are defined during construction and testing, and the final operating program is then approved by the regulatory agency.

Injection rates and pressures must be considered jointly, since the pressure will usually depend on the volume being injected. Pressures are limited to values that will prevent damage to well facilities or to the confining formations. The maximum bottom-hole injection pressure is commonly specified on the basis of well depth. It may range from about 0.5 to 1.0 psi per foot of well depth, depending on the geologic conditions, but it is seldom allowed to exceed about 0.8 psi per foot of depth.

Experience with injection systems has shown that an operating schedule involving rapid or extreme variations in injection rates, pressures, or waste quality can damage the facilities. Consequently, provision should be made for shut-off in the event of hazardous flow rates, pressure, or waste quality fluctuations.

## Operating Procedures

Wastewater injection well systems are normally operated by technicians, with supervision by professional engineers or scientists. Because such systems can be complex, and because the operating personnel will usually be inexperienced in injection well operation, all details of the system's operating procedures should be documented as thoroughly as possible in an operator's manual. The consultants employed to design and supervise construction of the system should prepare such a manual in cooperation with the well operator's supervisory-level personnel. Since the operating procedures will be unique to each system, no attempt will be made here to specify the contents in detail. However, some of the essential subject matter would include instructions relating to the sources and composition of the wastewater streams to be handled, to the nature and operation of pre-injection wastewater treatment systems, to monitoring procedures, to regulatory requirements, and to any emergency pro-

cedures. It is common to provide training sessions to educate operating personnel when a new system is to be put into operation.

### Contingency Plan

A plan should be developed by the well operator and approved by the state regulatory agency for an alternative waste management procedure if the injection well should become inoperative or if it needs to be shut down. Such a plan requires the availability of standby facilities, which could be a standby well, holding tanks or ponds, or a waste treatment plant.

### Full-Scale Operations

The transition from the last stage of development to full-scale operation should be gradual. The disposal operator must recognize that, as the pressure front and the leading edge of the effluent radiate outwards, exploration and development are a continuous process.

When waste injection into the subsurface is begun, the operator immediately incurs an obligation. The requirements of knowing "what it is," "where it is," and "what it is doing," are not relieved until the project is both chemically and hydrodynamically inactive. This may be a period of months, years, or decades after the cessation of injection.

## PROBLEMS ENCOUNTERED DURING START-UP

### Compatibility of New Wastewater Streams

A tight screening policy is necessary when any new waste streams are added to the injection well system (Veir, 1967). It should be re-emphasized here that any new waste resulting either from a new process or from a process change must first be subjected to compatibility tests that utilize samples of "design" wastewater (as discussed in previous chapters). If compatible, these streams are then routed to the injection well system. If testing shows that these wastes are not compatible, however, further testing should be performed to isolate the particular stream or component causing the sample to fail the compatibility test. If means cannot be found to make a given stream compatible, an alternate disposal route for the waste must be used. Process wastes are frequently found to be incompatible "as received." However, pH alteration or treatment with other wastes will frequently render the waste in question compatible with the "design" wastewater.

The importance of compatibility tests should not be underestimated. An example of incompatibility between an injected fluid and the receiving reservoir occurred when a new injection well system was installed and shut-in pending the start-up of a new plant (Davis and Funk, 1974). During plant construction, the transfer lines to the injection well were pressure-tested with fresh water, but were not drained. When the well was put into service, the fresh water was displaced into the well, causing extensive formation damage due to the hydration of water-sensitive clays. The result was a \$250,000, 6,000-foot hole in the ground.

## Clogging

According to Brown and Spalding (1966), one common start-up problem involves clogging which results from bacterial growth caused by drilling fluid and water that entered the well during the construction, testing, and review periods. Biocides can aid in preventing such problems, especially if wastewater injection is not begun within a few days of the completion and fitting of the injection well.

Another possible problem area is illustrated by West's description (1972) of one of the early problems the Anaconda Company experienced during injection of uranium-mill effluent in New Mexico. After an initial 90-day test indicated that injection was feasible at a rate of approximately 400 gpm under gravity flow, and that the upper aquifers containing potable ground water did not show any indications of contamination, state and federal agencies granted Anaconda permission to use the well for operational injection, provided the injection well was operated with the injection head lower than land surface, i. e., by gravity flow only. Problems developed, however, soon after injection began, when clogging of the well screens and of the injection interval decreased the design input of 400 gpm to 125-250 gpm with an accompanying rise of water level to near land surface.

One cause of the decrease in injectivity was related to low levels in the tailings pond, which picked up fine-grained sediment and overloaded the on-line decanter, allowing entry to the injection well, and subsequently clogging the screens and the injection interval. Another suspected cause compounded the initial problems: wastewater quality varied significantly during the early years of injection, which may have created unexpected compatibility problems. In later years, the wastewater quality was normalized, and tailing ponds were monitored to avoid low levels and the resultant introduction of fine-grained material.

## Routine Checks

Although a properly designed and maintained injection well system should give years of reliable service, reliable records and routine checks on the system's conditions are very important. Inconsistency between a well's actual condition and the condition reported by instruments, records, and operating personnel reports, for example, can cause unnecessary expenditures. In some cases, incorrect or inadequate records can cause the workover costs to exceed the new installation costs. One such experience was with a company that had purchased a small chemical plant with two injection well systems (Davis and Funk, 1974). Since the title and the responsibility for the wells were changing hands, the state required that a series of tests be performed to insure the condition of the wells and to obtain information needed to bring the existing records up to date. The original cost estimate was \$10,000 for both systems. However, when these wells were entered, the casing on one well was so badly damaged that the well had to be plugged back and recompleted. The other well was completed some 200 feet shallower than was shown in the records. Thus, the actual cost to put the wells back into service was almost \$50,000.

Most regulatory agencies require the well operator to keep periodic operating records. Start-up data, which describe the initial operating conditions, are especially important since they will serve as a basis for comparison with later data. Figures 8-1 and 8-2 are typical examples of the formats used.

#### STATE REQUIREMENTS FOR APPROVAL OF OPERATIONS

Walker and Cox (1976) suggest that the variation in details of well operation between individual wells limits the extent to which state control measures lend themselves to formalization as explicit provisions. Thus, in the majority of cases, regulatory procedures do not set forth detailed standards, but rather require that all aspects of operation be subject to approval by the appropriate regulatory agency.

However, formal controls do include specific provisions in some cases in some states. The Nebraska Environmental Control Council (1974), the Michigan Department of Natural Resources (1972), the Oklahoma Water Resources Board (1972), and the Texas Water Quality Board (1972) have specific regulatory provisions relating to operation. The provisions should be reviewed in detail, but, in general, they emphasize many of the topics considered in this and other chapters of this text. Basically, the states emphasize

1. Procedures for operation relating to anomalous behavior of the well;
2. Statements requiring the elimination or correction of leaks or losses of fluids and pressure;
3. Exclusion of operations that may cause or create a condition endangering public health or welfare;
4. Requirements for "adequate" equipment, and installations for "appropriate" testing and monitoring of the operation;
5. Requirements that wastes shall be "treated" prior to injection, unless otherwise authorized;
6. Requirements for the collection of records or reports, forms, charts of operating pressures, of rates of injection, of types and volumes of fluids injected or withdrawn and their submission monthly or at other specified intervals;
7. Requirements that wastes shall be treated and stored before their injection in such a manner to avoid ground water pollution;
8. Requirements for filing requests for change of status before rework operations are commenced; and
9. Requirements that volumes of specific wastes, injection rates, and pressures shall not vary from those specified in the original state approval specifications.

I. OPERATING PERIOD

Month \_\_\_\_\_ Year \_\_\_\_\_

II. WELL OPERATOR

1. Name \_\_\_\_\_
2. Address \_\_\_\_\_
3. City \_\_\_\_\_ State \_\_\_\_\_
4. Phone number \_\_\_\_\_
5. Permit number \_\_\_\_\_

III. SUMMARY OF OPERATIONAL DATA

A. Injected Volumes

1. Maximum daily volume specified in permit \_\_\_\_\_ gal/day
2. Maximum daily volume during operating period \_\_\_\_\_ gal/day
3. Present average daily volume \_\_\_\_\_ gal/day
4. Total volume injected to date \_\_\_\_\_ gal.

B. Injection Rate

1. Maximum injection rate specified in permit \_\_\_\_\_ gpm
2. Maximum injection rate during month \_\_\_\_\_ gpm
3. Average injection rate during month \_\_\_\_\_ gpm

C. Injection Pressure

1. Maximum well-head injection pressure specified in permit \_\_\_\_\_ psi
2. Maximum well-head injection pressure during month \_\_\_\_\_ psi
3. Estimated average well-head injection pressure during month \_\_\_\_\_ psi

IV. DETAILED OPERATIONAL DATA (supply detailed well operating record to accompany this report).

V. INSTRUCTIONS

- A. Each operator of an injection project shall furnish information on this form not later than the 10th day of the month following the month reported.

(Continued)

FIGURE 9-1. MONTHLY OPERATIONAL INFORMATION AND REPORT FORM (NOV. 1975)

FIGURE 8-1. Continued

- B. If several wells are utilized, report each one separately.
- C. Fill in reverse side of form relative to daily injection practices.
- D. Continuous recording charts will be made available upon request.
- E. All operational problems, changes in injection system or wastes are to be reported when they occur.

1. CONTINUOUS OPERATING PERIOD		Length of Period (days & hrs)	2. INJECTION RATE (GPM)		3. PRESSURE (PSI)			4. FLUID INJECTED (GAL)	
Start Date	End Time		Aver	Max	Well-Head Injection Estimated Average	Casing Tubing Annulus	Operating Period	Total Cumulative	

NOTE: Report items 2 and 3 for each day of operating periods that exceed one day.

FIGURE 8-2. INJECTION WELL OPERATING RECORD (CRSANCO, 1973)

## CHAPTER 8

### REFERENCES

- Brown, R. W., and Spaulding, C. W. "Deep-Well Disposal of Spent Hard Wood Pulping Liquors." Journal Water Pollution Control Fed. Vol. 38. 1966. pp. 1916.
- Davis, K. E., and Funk, R. J. "Subsurface Disposal of Industrial Waste." Ind. Water Eng. Sept. - Oct. 1974. pp. 14-17.
- Michigan Department of Natural Resources. "General Rules Governing Mineral Well Operations." June, 1972.
- Nebraska Department of Environmental Control. "Rules and Regulations for the Control of Disposal Wells to Protect Groundwater and Other Subsurface Resources of the State of Nebraska." June, 1975.
- Ohio River Valley Water Sanitation Commission. Underground Injection of Waste-Waters in the Ohio Valley Region. ORSANCO, Cincinnati, Ohio. 1973.
- Texas Water Quality Board. "Subsurface Waste Disposal in Texas." Agency Publication No. 72-05. February, 1972.
- Veir, B. B. "Celanese Deep-Well Disposal Practices." Proc. 7th Ind. Water and Waste Conf. Univ. Texas. June 1-2, 1967. pp. 111-125.
- Walker, W. R., and Cox, W. E. Deep Well Injection of Industrial Wastes: Governmental Controls and Legal Constraints. Virginia Water Resources Research Center, Blacksburg, Virginia. 1976. 163 pp.
- West, S. W. "Disposal of Uranium-Mill Effluent by Well Injection in the Grants Area, Valencia County, New Mexico." U.S.G.S. Prof. Paper 386-D. 1972. 28 pp.



## CHAPTER 9

### INJECTION WELL MONITORING

The principal means of surveillance of wastewater injection that is presently practiced is monitoring at the injection well of the volume, flow rate, chemistry, and biology of the injected wastewater and of the injection and annulus pressures (Figure 9-1). To some this apparently seems inadequate. However, if all of the necessary evaluations have been made during the planning, construction, and testing of the well, then this may be a satisfactory program, when combined with periodic inspection of surface and subsurface facilities. This is because, as pointed out by Talbot (1972), the greatest risk of escape of injected fluids is normally through or around the outside of the injection well itself, rather than from leakage through permeable confining beds, fractures, or unplugged wells.

The purpose of monitoring the volume and chemistry of injected wastewater is to allow for estimates of the distance of wastewater travel, to allow for interpretation of pressure data, and to provide a permanent record. This record is needed as evidence of compliance with restrictions, as an aid in interpretation of well behavior, in well maintenance, and as a precaution in the event that a chemical parameter should deviate from design specifications. Some characteristics that have been monitored continuously are flow, suspended solids, pH, conductance, temperature, density, dissolved oxygen, and chlorine residual. Complete chemical analyses are frequently made on a periodic basis on composite or grab samples. Because bacteria may have a damaging effect on reservoir permeability, periodic biological analysis of some wastewaters may be desirable to insure that organisms are not being introduced.

Injection pressure is monitored to provide a record of reservoir performance and as evidence of compliance with regulatory restrictions. Injection pressures are limited to prevent hydraulic fracturing of the injection reservoir and confining beds, or damage to well facilities. As with flow data, injection pressure should be continuously recorded.

Pressure fall-off data collected after any extended period of continuous operation can be used to check the performance of the reservoir as compared with its original condition. However, it should be noted that the time scale of continuous recorders is not generally adequate for providing data during the early period of a pressure fall-off test, so the continuously recorded data will probably need to be supplemented with additional observations in order to have a complete record of the test. Also, bottom-hole pressure buildup or fall-off can be periodically measured using a Bourdon gage or

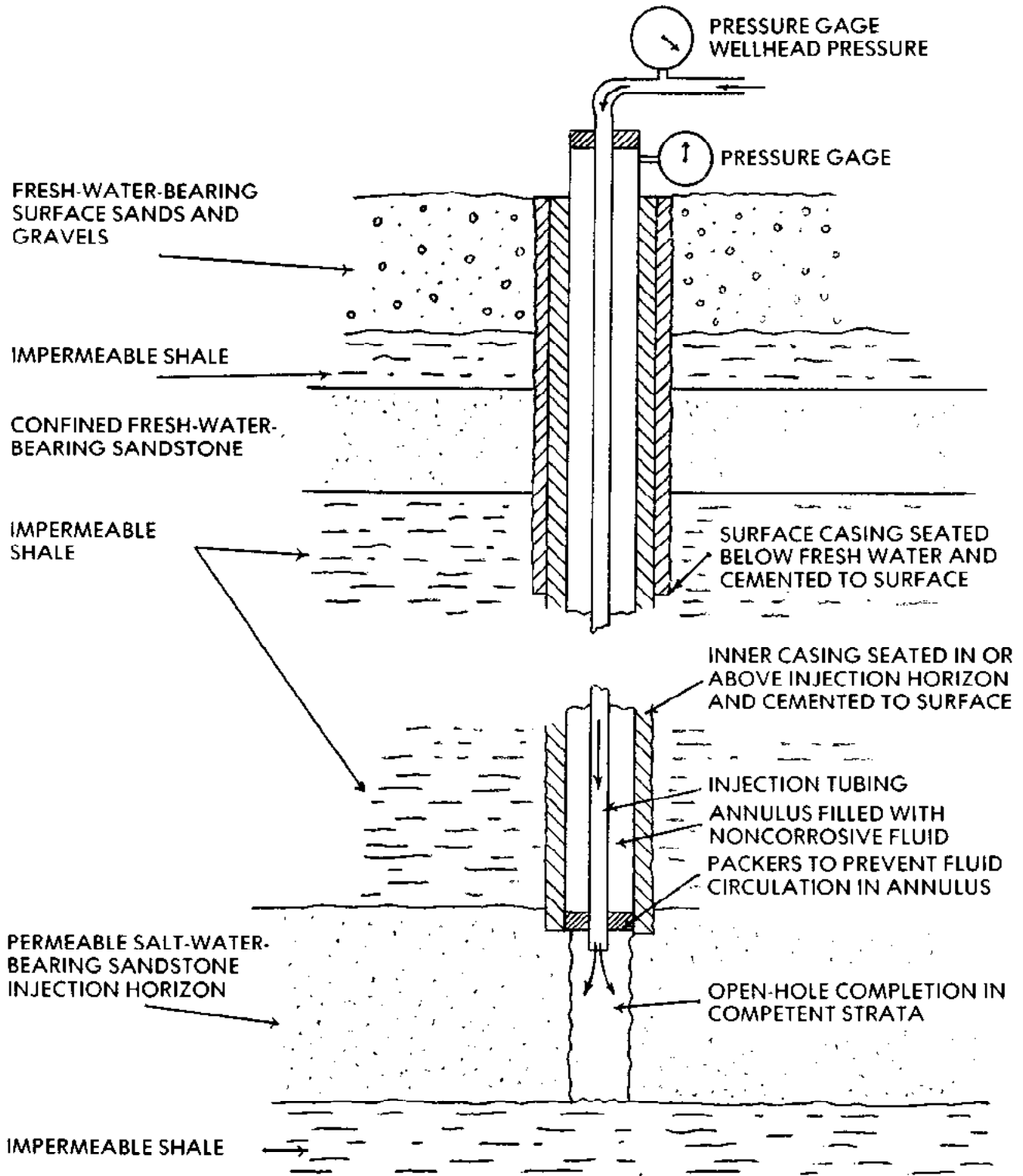

FIGURE 9-1. SCHEMATIC DIAGRAM OF AN INDUSTRIAL WASTE INJECTION WELL COMPLETED IN COMPETENT SANDSTONE (MODIFIED AFTER WARNER, 1965).

a piezoelectric gage. Bottom-hole gages can give a more accurate reading of injection pressure at the formation face than can be obtained by measuring pressure at the surface and computing the bottom-hole pressure.

Figure 3-12 is an example of the pressure response that would ideally be expected during a period of continuous injection. Pressure increase through time should be linear on a semilogarithmic scale, after an early period of adjustment.

In contrast with this ideal behavior, Figure 9-2 shows the injection pressure history of a wastewater injection well completed in a carbonate reservoir. Two marked periods of pressure decline are shown, one in 1967-68 and one in 1970. The explanation for this is believed to be that the wastewater being injected, initially an acid solution, reacted with the carbonate reservoir to increase the permeability and thus decrease the injection pressure. The period of gradual pressure increase during 1969-1970 is probably the normal buildup following this initial period of permeability increase. In 1970, the wastewater composition was changed to include a second acid stream. This new stream apparently caused additional permeability increase and a temporary reduction in injection pressure, after which the expected pressure buildup resumed.

Figure 9-3 shows the plots of two pressure fall-off tests performed in an injection well of the Monsanto Company, Pensacola, Florida. This well is also constructed in a carbonate aquifer. One test was made in November 1967, before injection of an acidic wastewater stream began. The other test was performed in January 1969, after the acidic wastewater had been injected for nine months. The second test shows a much slower rate of fall off, indicating an increased permeability in the vicinity of the well bore caused by a reaction of the acidic wastewater with the carbonate aquifer. This conclusion is substantiated by an increase in the injection index for this and another well during the same time period, as shown in Figure 9-4.

Some other possible causes of deviation from the ideal response are the presence of hydrologic barriers or conduits, leaky confining beds, and permeability reduction from suspended solids, chemical reactions, etc. The variety of factors that may influence well behavior indicates the need for maintaining an accurate, detailed well history so that the probable cause of any unusual performance can be deduced and the appropriate action taken.

Pressure in the casing-tubing annulus is monitored to detect any changes that might indicate leakage through the injection tubing or the tubing-casing packer. When a packer is used, three different operational procedures are possible. If fluid in the casing-tubing annulus is not pressurized, then the pressure would be expected to be zero. However, it often will not be, because of effects such as expansion of injection tubing and thermal expansion or contraction of the fluid in the annulus. If fluid in the annulus is pressurized, it may be kept either below or above the pressure in the injection tubing. In any of the three cases, leakage is indicated by an abnormal change in the annulus fluid pressure.

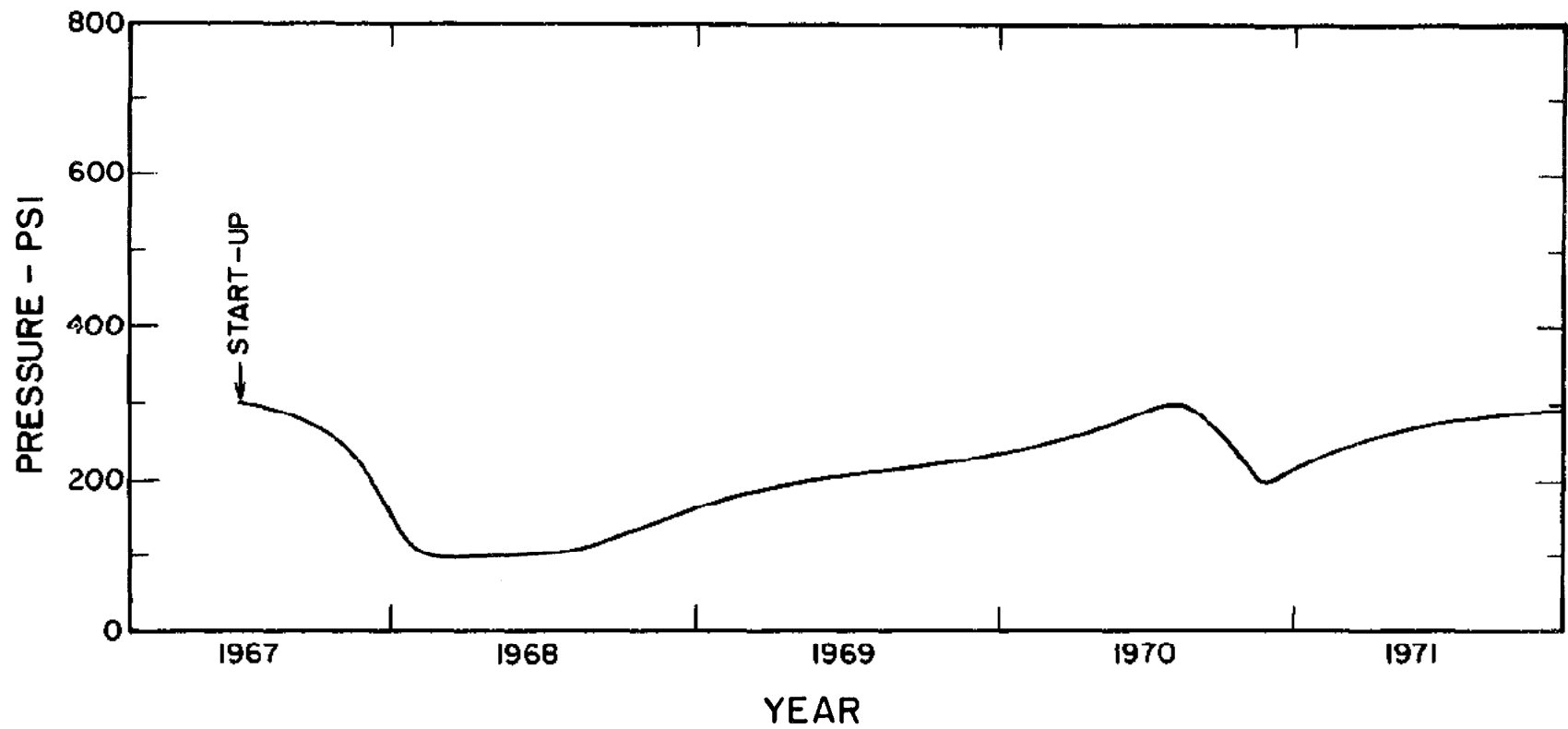

FIGURE 9-2. PRESSURE HISTORY OF A WELL INJECTING INTO A CARBONATE AQUIFER.

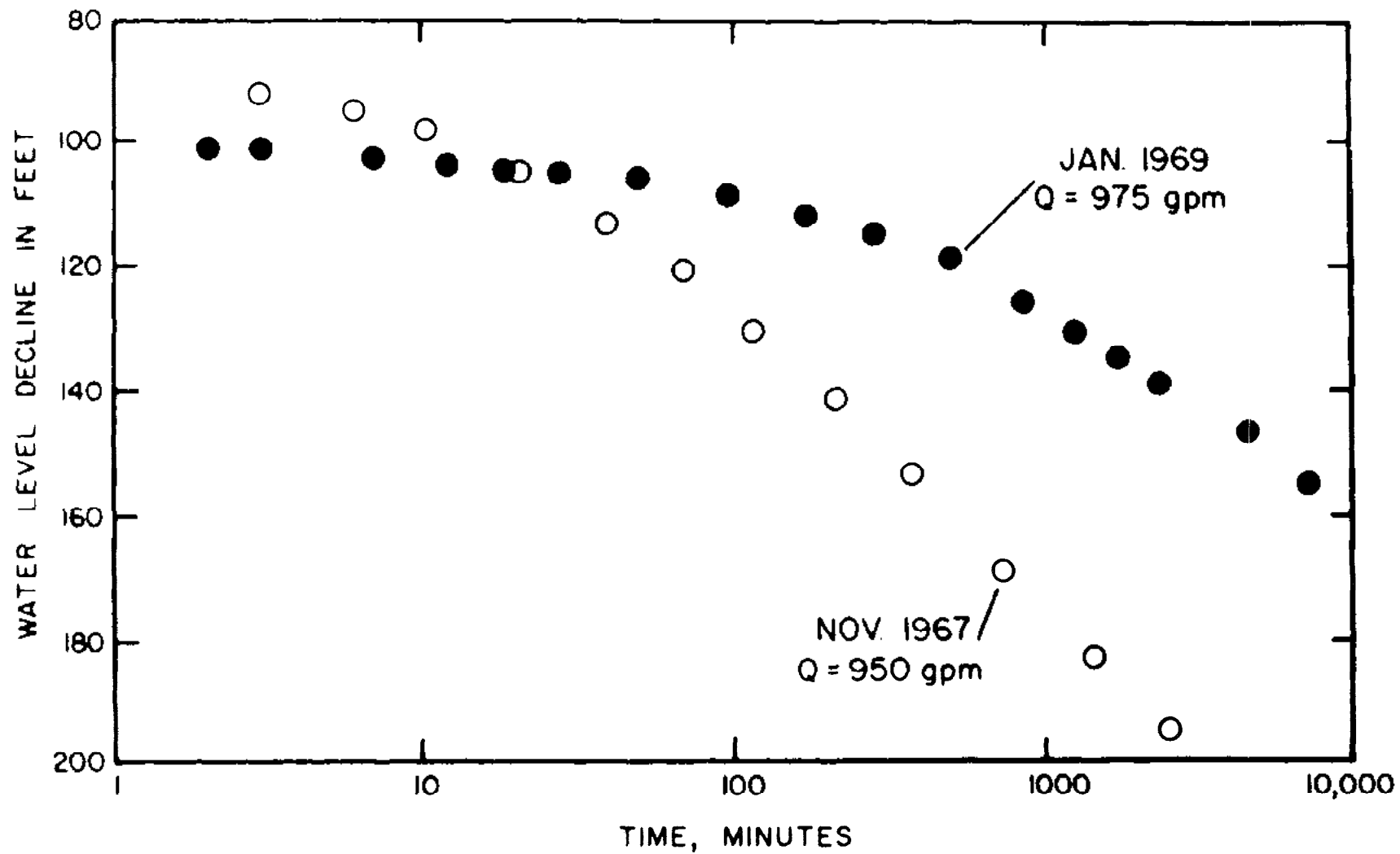

FIGURE 3-3. SEMILOGARITHMIC PLOT OF TWO PRESSURE FALL-OFF TESTS MEASURED IN AN INJECTION WELL OF THE MONSANTO COMPANY, PENSACOLA, FLORIDA (GOOLSBY, 1971).

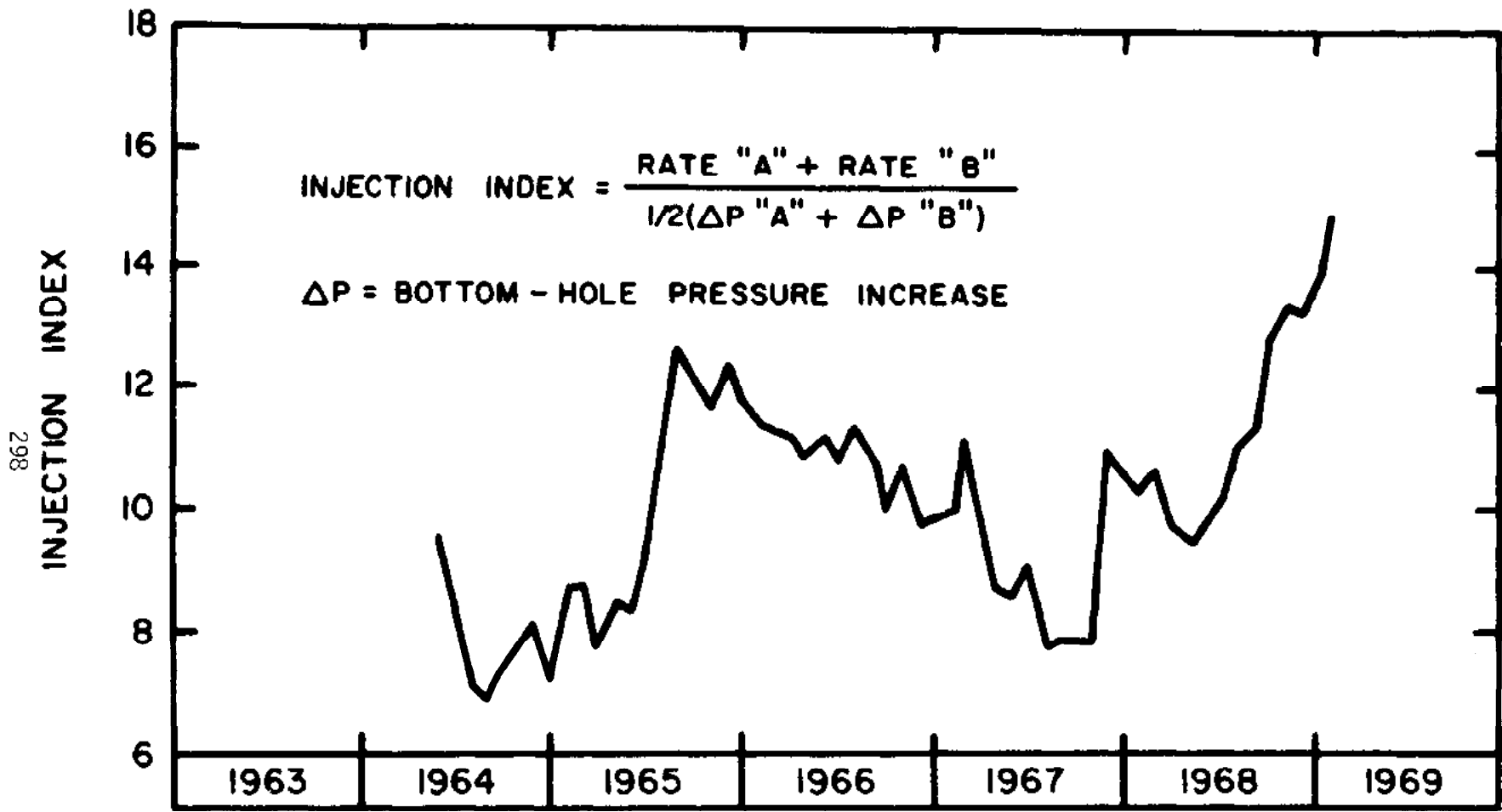

FIGURE 9-4. MONTHLY AVERAGE INJECTION INDEX OF TWO INJECTION WELLS OF THE MONSANTO COMPANY, PENSACOLA, FLORIDA (GOOLSBY, 1971).

Other methods of injection well monitoring also deserve mention. The corrosion rate of well tubing and casing may be monitored by use of corrosion coupons inserted in the well. Corrosion coupons are weight-loss specimens of the same metal as the tubing or casing. They are carefully cleaned and weighed before exposure, exposed for a carefully measured period of time, and then removed, cleaned, and reweighed. The weight was divided by the specimen area and time of exposure gives the corrosion rate, usually in mills per year.

A conductivity probe may be used to detect a change in the chemistry of the fluid in the casing-tubing annulus. In wells with packers, the conductivity probe can be used to detect tubing leaks, and in wells without packers to detect shifts in the interface between the injected fluid and the casing-tubing fluid. Another technique that has been used to monitor the casing-tubing annulus is continuous cycling of the annulus fluid and analysis of the return flow for evidence of contamination by wastewater.

#### PERIODIC INSPECTION AND TESTING

Sufficient incidents have occurred in the past to emphasize the need for periodically inspecting or testing the subsurface facilities of injection wells, particularly when chemically reactive wastes are being injected. The most frequently reported problem has been corrosion of tubing and/or casing. Several cases have been reported in which portions of tubing or casing have failed by corrosion and caused temporary or permanent shutdown of the well. There may also be reason to examine the well bore to check for the location of zones of wastewater entrance, enlargement due to chemical reaction, the location and orientation of induced fractures, build up of precipitates or filtered solids, etc. Examples are available of wells that have been abandoned or modified because of borehole enlargement that led to collapse of the borehole or damage to the casing or cement near the bottom of the casing string.

Methods of inspection of casing, tubing, cement and the well bore are:

1. Pulling of tubing and visual or instrumental inspection.
2. Inspection of casing or tubing in place, using electromagnetic logs.
3. Inspection of casing, tubing in place, or the well bore with caliper or televiewer logs.
4. Pressure testing of casing.
5. Inspection of casing cement with cement bond logs.
6. Inspection of casing cement, or the well bore with injectivity or temperature profiles or other appropriate logs.

The process of pulling and inspecting tubing is self-explanatory. Mechanical methods are available, for example, for inspection of lined steel tubing for flaws in the lining. Individual joints of tubing can be pressure tested at the surface for leakage.

Electro-magnetic down-hole casing or tubing inspection services are provided by oil field service companies. These logs indicate, by virtue of the electromagnetic response of steel pipe, the relative pipe thickness. Thin areas may indicate corrosion or other damage, either on the inside or outside of the pipe. Another similar device relates surface currents induced on the inside of tubing or casing to inside pipe diameter. Figure 9-5 illustrates a typical simultaneous Electronic Casing Caliper Log and Casing Inspection Log run in 7 in. OD casing. The wall thickness as measured by the Casing Inspection Tool is shown on the right. Casing collars are indicated at 6,412; 6,452; and 6,495 ft. The deflection to the right is caused by the mass of the casing collars; the double response is due to the two-coil measuring system. The Electronic Casing Caliper Log is shown on the left side of the depth column. The single sharp deflection to the right at each collar is caused by the natural separation that exists between casing joints. The anomaly at 6,428 ft. is interpreted as a hole caused by external pitting corrosion (McCullough Services, undated). Figure 9-6 is a similar type of log, along with photographs of the casing that was pulled after running the log. If such logs are run early in the life of the well, then runs that are made later after the well has been in operation are more easily interpreted.

Mechanical caliper logs provide a record of the inside diameter of pipe or borehole walls and may show intervals of pipe corrosion, borehole enlargement, or borehole plugging at the formation face. Figure 9-7 shows portions of a caliper log run before injection and after five years of injection of an acidic wastewater into a limestone aquifer. The log indicates considerable borehole enlargement as a result of dissolution of the limestone by the injected acidic waste in the interval from 1500 to 1600 feet. It would be reasonable to conclude that most of the wastewater entered that interval.

Borehole viewers provide an image of the pipe or borehole wall as produced by the reflection of sound waves emitted from a sonde (Zemanek, 1970). The combination sound source and receiver is highly directional and is rotated rapidly as the tool is moved up the hole. Thus, the hole is continuously scanned. The resulting information is displayed on an oscilloscope and a film made of the scope display. The picture obtained depicts the well bore as though it were split open and laid out for inspection. Figure 9-8 illustrates the detail with which the borehole viewer can indicate casing damage. Figure 9-9 depicts viewer logs run in a well in the Piceance Basin, Colorado, before and after hydraulic fracturing. The dark area in the "after" log is a vertical hydraulic fracture (Bredenhoef, et. al., 1976).

Pressure testing can be used to detect casing leaks and it is required by law in many oil-producing states as a method of testing the integrity of casing in new wells at the time that the casing is cemented into the borehole. In such tests, a cement plug is left at the bottom of the casing during cementing and allowed to harden. The interior of the casing is then subjected



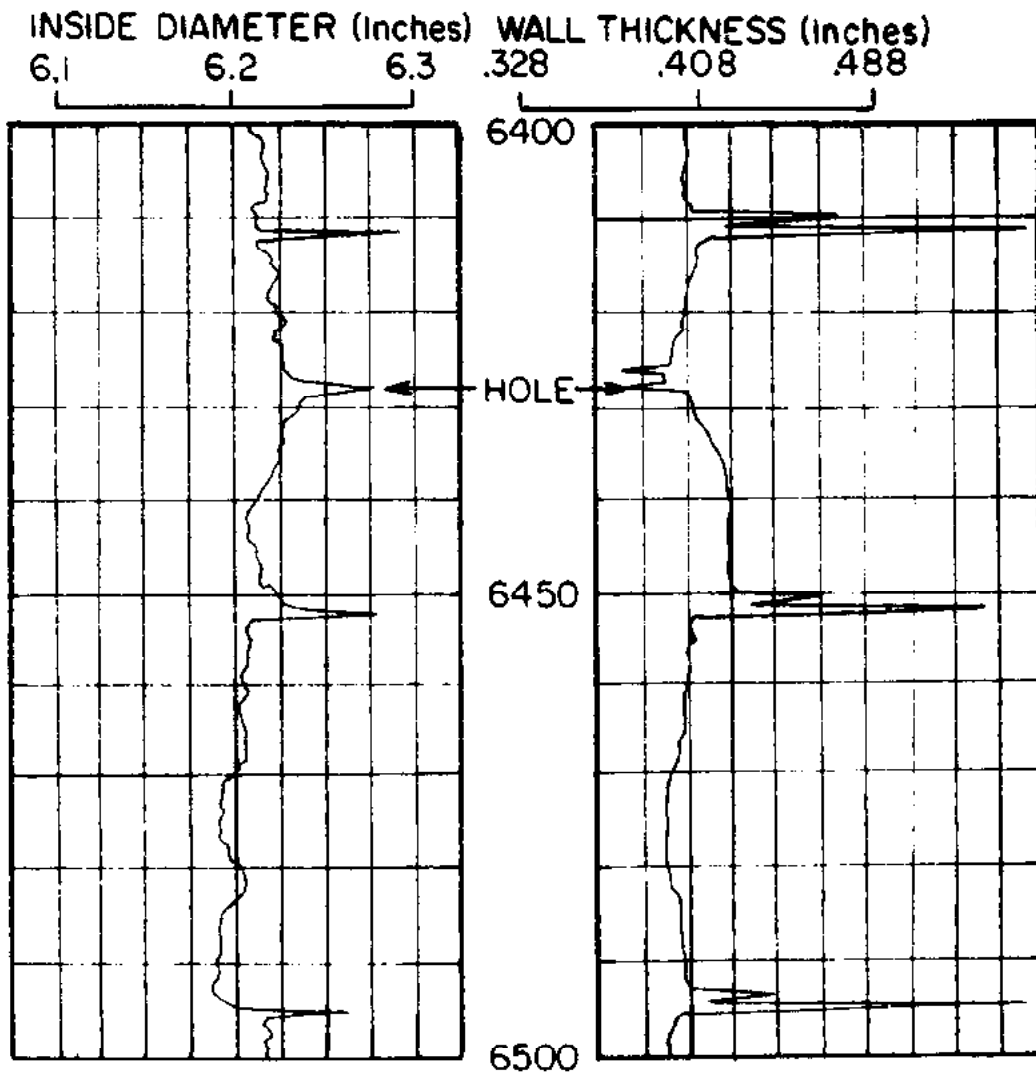

FIGURE 9-5. TYPICAL SIMULTANEOUS ELECTRONIC CASING CALIPER AND CASING INSPECTION LOGS RUN IN 7 INCH O.D. CASING (McCULLOUGH SERVICES, UNDATED).

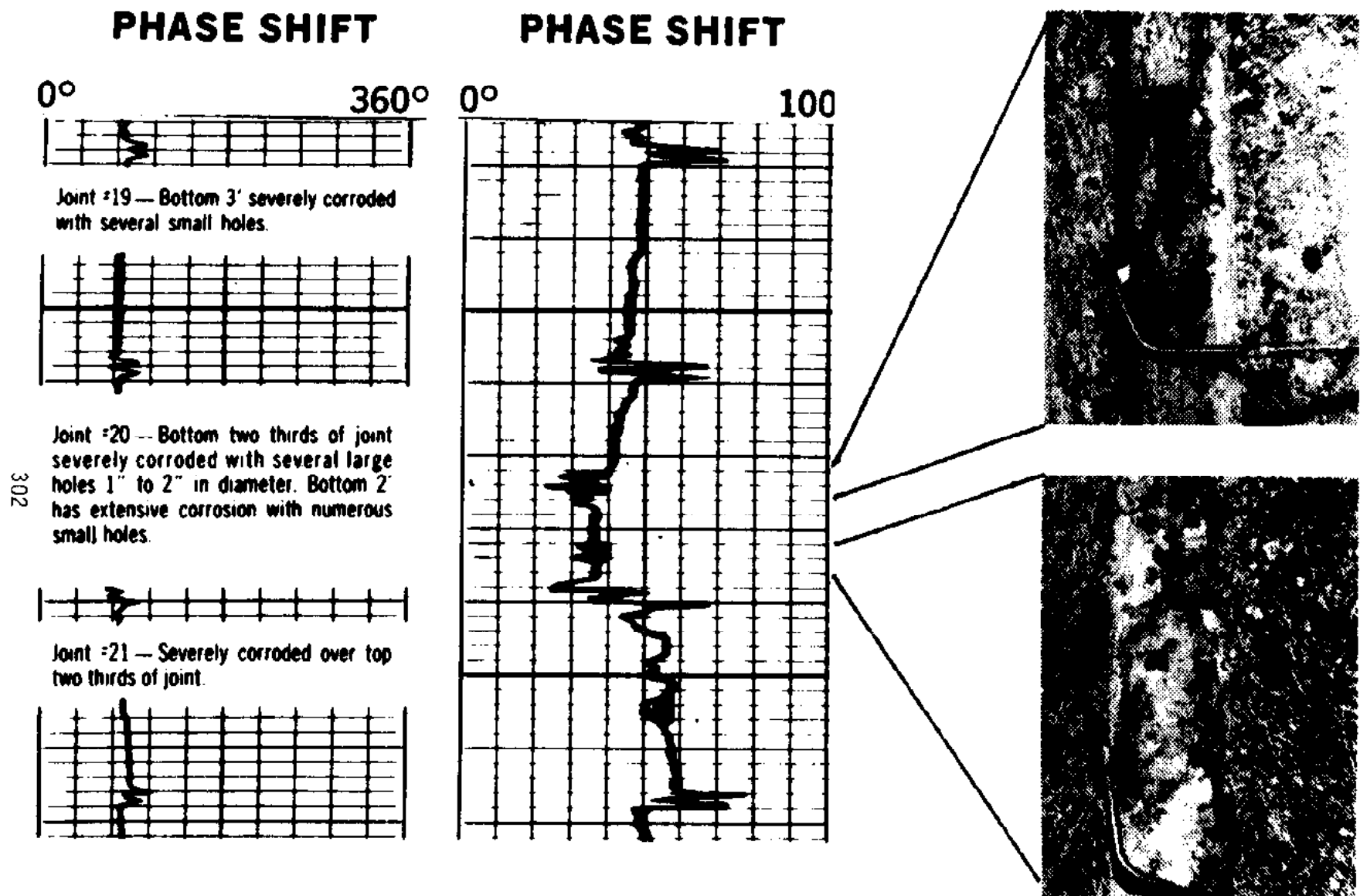

FIGURE 9-6. PIPE INSPECTION LOG AND PHOTOGRAPHS OF CASING PULLED AFTER LOG WAS RUN TO VERIFY THE LOG (SCHLUMBERGER, 1970).

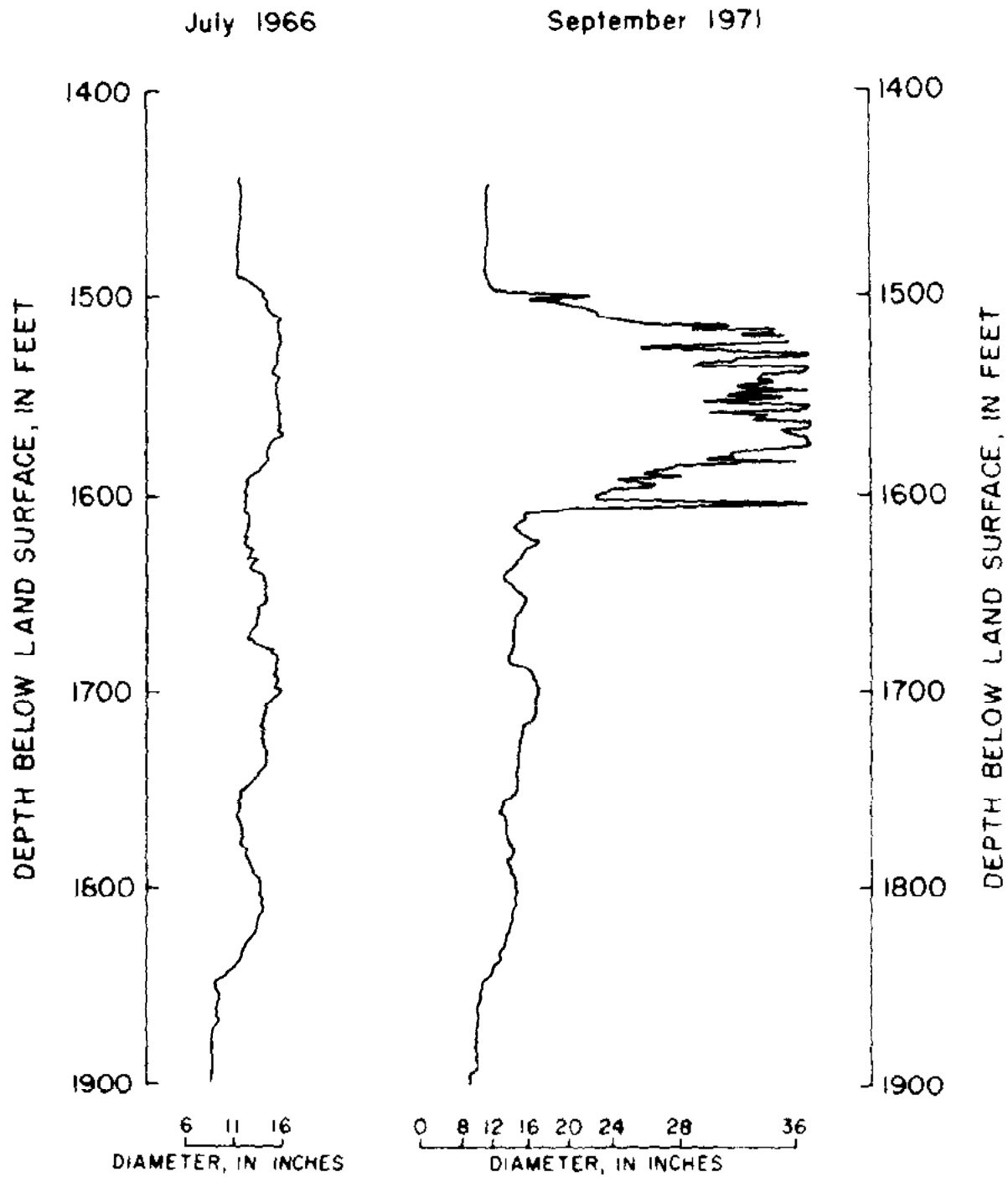

FIGURE 2-7. PPE-INJECTION AND POST-INJECTION CALIPER LOGS FROM A WASTEWATER INJECTION WELL AT BILLY GLADE, FLORIDA, SHOWING SOLUTION OF THE LIMESTONE AQUIFER IN THE 1500- to 1600-FT. INTERVAL BY ACIDIC WASTEWATER (SWAN, CROW, AND LINDNESS, 1972).

# BOREHOLE TELEVIEWER

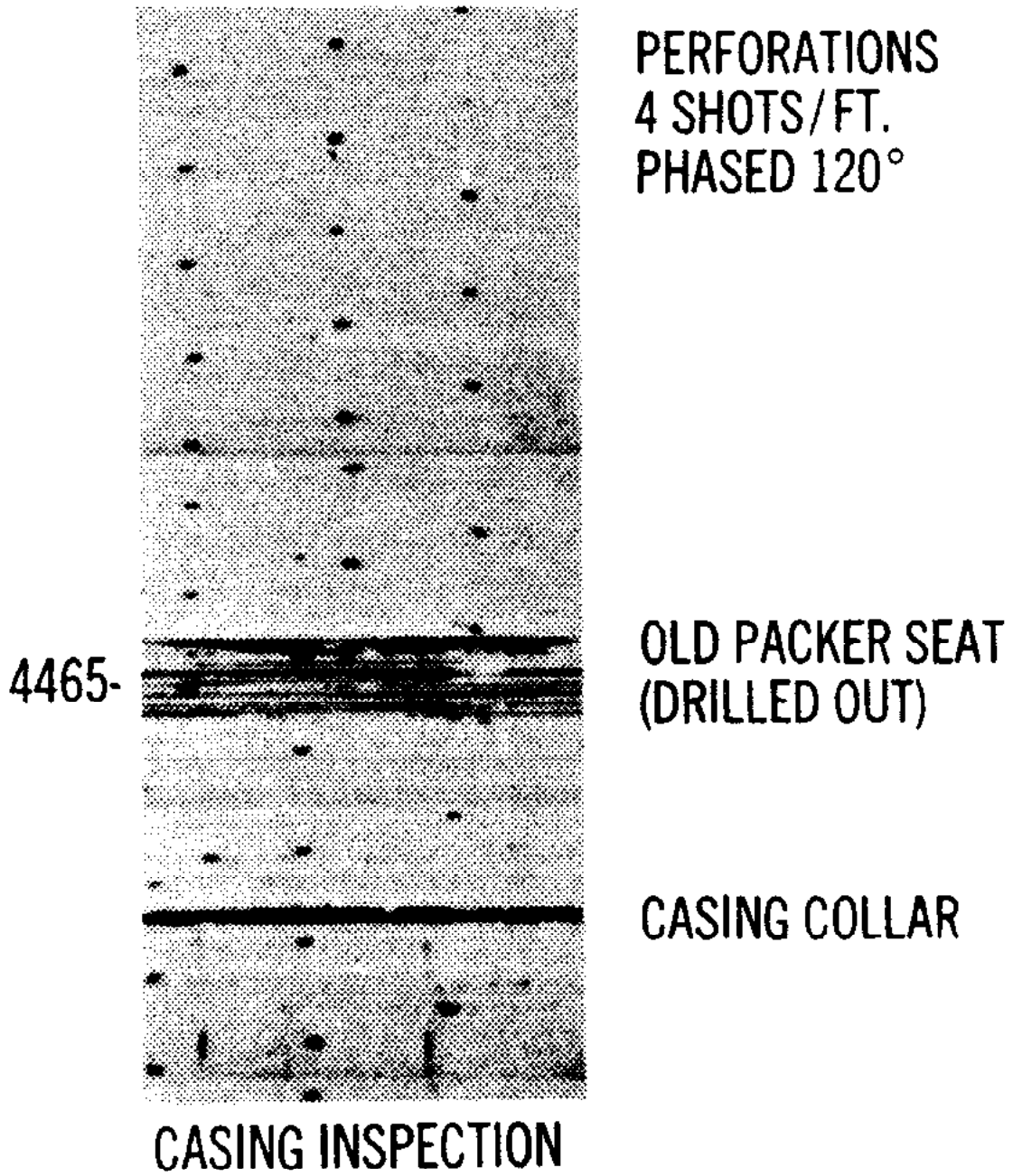

FIGURE 9-8. BOREHOLE TELEVIEWER LOG OF A SECTION OF CASING PERFORATIONS, PACKER SEAT, AND CASING COLLAR (SCHLUMBERGER, 1970).

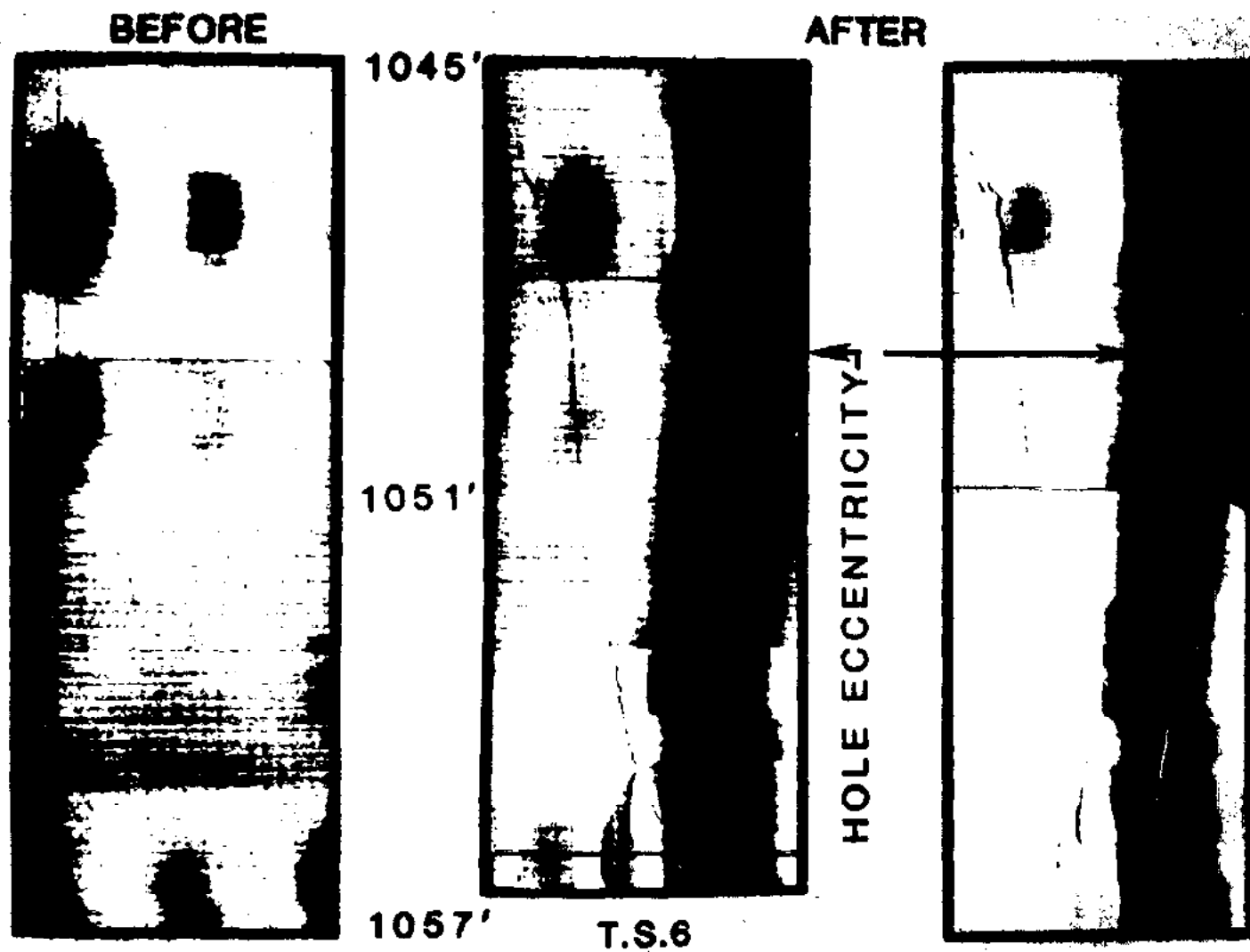

FIGURE 9-9. TELEVIEWER LOGS RUN BEFORE AND AFTER HYDRAULIC FRACTURING OF A WELL IN THE PICEANCE BASIN, COLORADO (BREDEHOEFT, ET. AL., 1976).

to a specified amount of fluid pressure (0.2 psi per foot of casing in Texas).<sup>1</sup> Rapid decline in pressure indicates leakage from the casing. Such a test could also be performed periodically in operating wells by setting temporary plugs or using packers.

The cement bond log is used to determine the quality of the casing-cement bonding and to detect channels in the cement behind the casing, or to detect damage to cement from high-pressure injection or chemical reaction. The cement bond log is a continuous measurement of the amplitude of elastic waves after they have traveled through a short length of pipe, cement, and perhaps formation (Figure 9-10). The amplitude of the elastic wave is maximum in uncemented casing and will generally be lower as the degree of bonding and integrity of the cement improves. Thus, the relative amplitudes of the waves in different portions of a well can be interpreted to indicate the condition of the cement and degree of bonding. Figure 9-11 shows portions of a cement bond log from an acid wastewater injection well. It appears that the casing in the vicinity of 1900 to 2000 feet is not bonded. The interval from 2700 to 2800 feet, near the base of the casing, shows progressively better bonding between the casing and cement. Figure 9-12 is an example of a modern cement bond log, the Acoustic Cement Bond Log/Micro-Seismogram, which consists of a pipe bond curve, formation bond curve, and the Micro-Seismogram. An additional log, usually a gamma ray or neutron log, is run for depth control, since these logs can detect formation contacts behind casing and can be compared with logs run before the well was cased. The figure shows intervals of good bond, poor bond, and no bond. The basis for the interpretation of the current cement bond logging devices is given by Walker (1968). Complications that occur in the interpretation of cement bond logs are discussed by Fertl et. al. (1974).

Some other possible inspection methods are flow-meter injectivity profiles, radioactive tracer injectivity profiles, and temperature profiles. Flow meter profiles indicate the amount of flow from an injection well into the permeable zones in adjacent formations. Measurement is made either continuously throughout the interval of interest or in increments that are isolated by packers. In either case, the measuring device is a spinner-type velocimeter. Only the location of exit of fluids from the well can be measured. The device does not detect fluid movement behind casing. Radioactive tracer injectivity profiles are based on the injection of a radioactive tracer and logging of the borehole with a gamma ray detector. The detector measures concentrations of tracer, which indicate paths of tracer flow. The method is useful in identifying permeable zones; locating casing, tubing, or packer leaks; and in detecting flow channels behind casing. Temperature profiles may indicate anomalies at points where injected fluids enter the receiving formation or where they escape through casing or tubing leaks. Such anomalies would most likely be detectable in wells where significant temperature contrasts exist between injected fluids and the aquifers.

Repetitive running of resistivity or radioactive logs may also be used to locate the zones that are accepting injected wastewater. Resistivity logs

---

<sup>1</sup>Texas Railroad Commission rules.

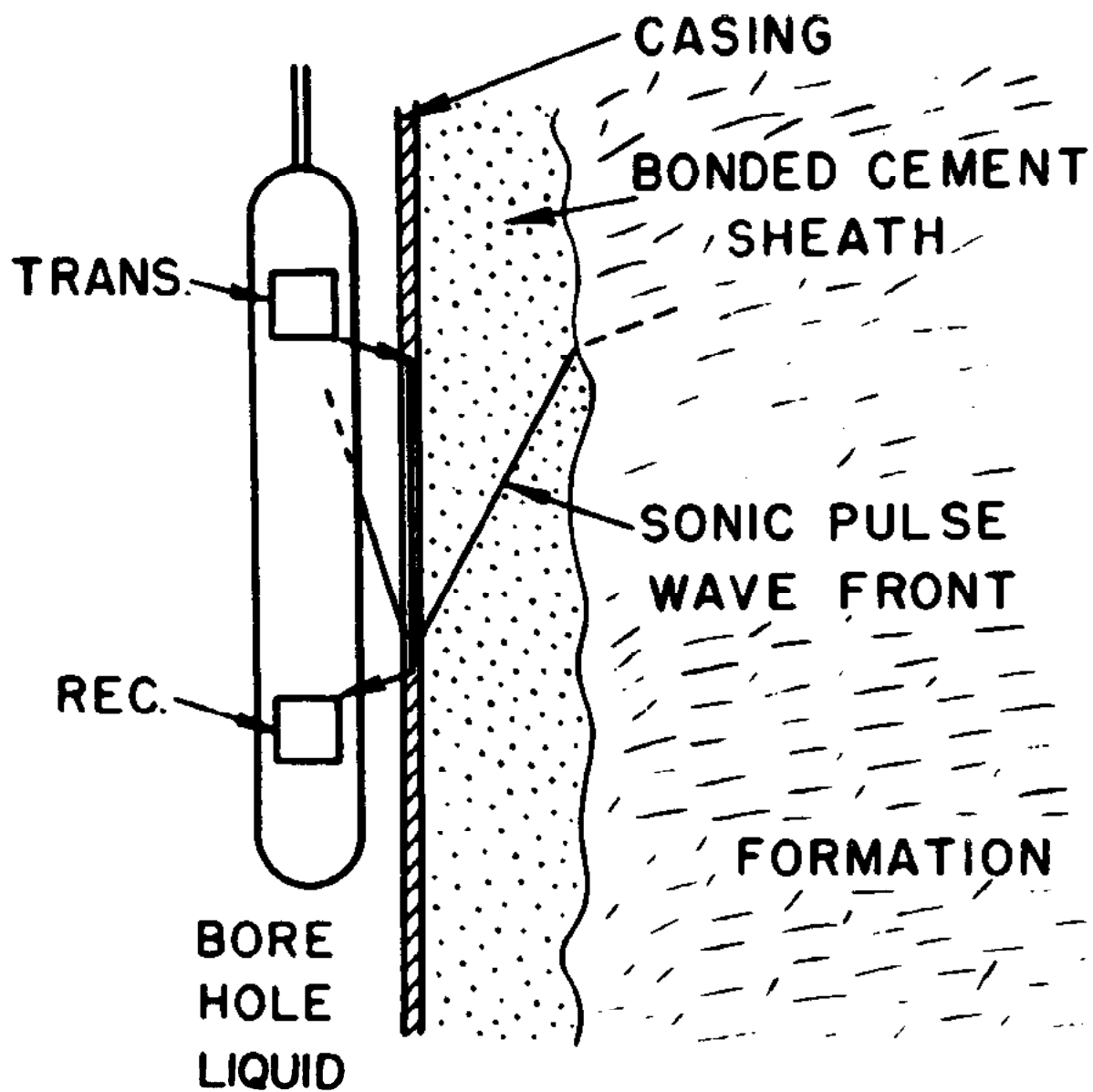

FIGURE 9-19. SCHEMATIC DIAGRAM OF A CEMENT BOND LOGGING TOOL IN A BOREHOLE (GROSMANGIN ET. AL., 1961).

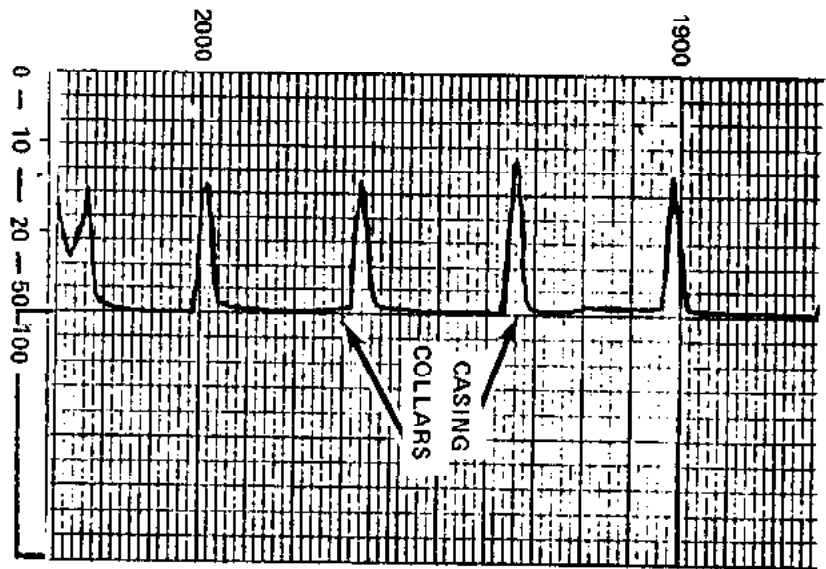
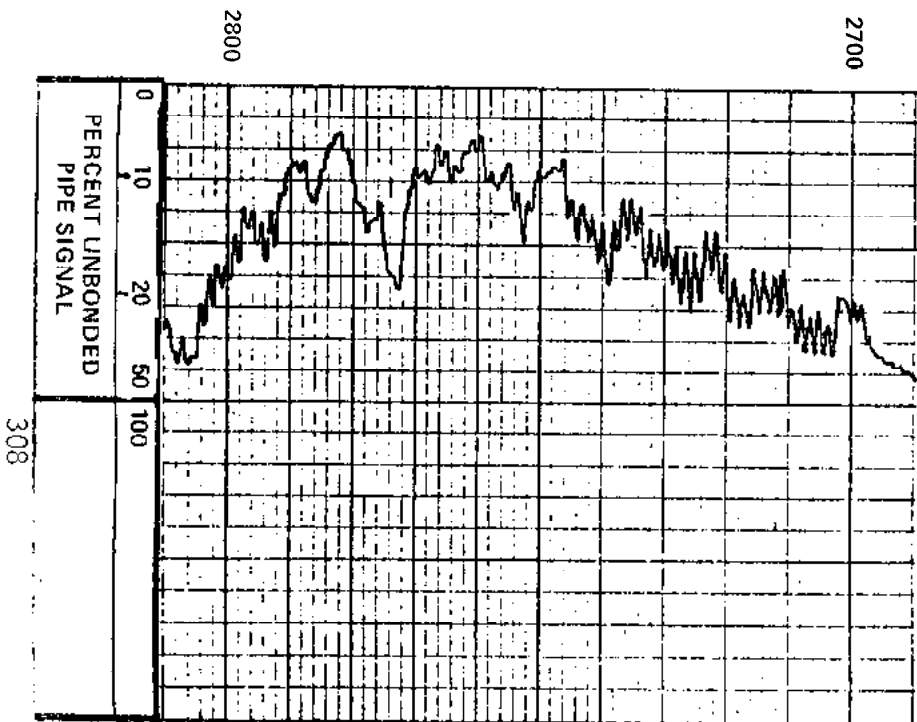
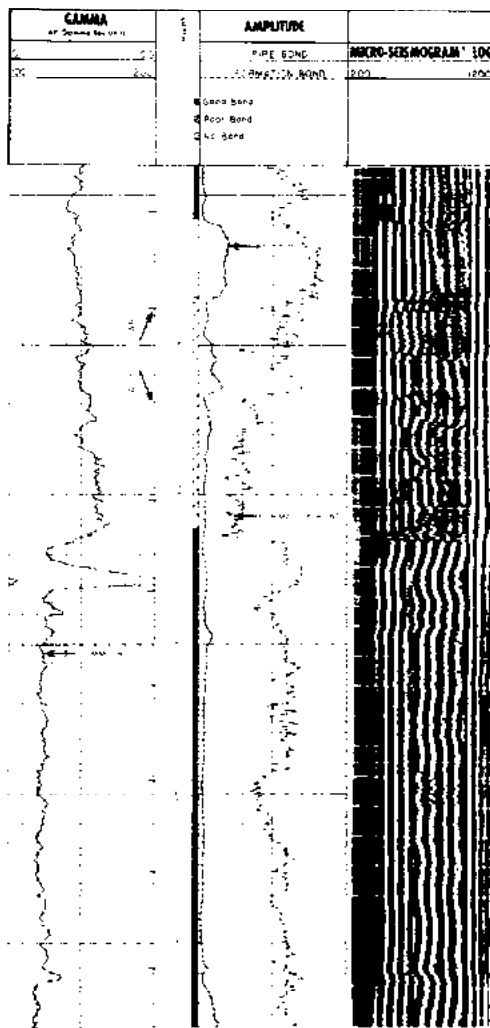

FIGURE 9-11. PORTIONS OF A CEMENT BOND LOG FROM AN ACID WASTEWATER INJECTION WELL.





**TOOL DATA**

O.D.	Length	Weight	Pressure Rating	Temperature Rating
2"	14.3	100#	20,000 psi	325 F
2 1/4"	24.8	160#	20,000 psi	325 F
3 1/4"	20	340#	20,000 psi	325 F
3 1/2"	27	370#	20,000 psi	325 F

**RECOMMENDED MINIMUM CASING SIZE, ID: 3 1/2" Tool, 4 1/2" Tool, 2 1/2" Tool, 2 1/2"**

Reference Literature: SPE Paper #1751

\*Without Gamma Ray

\*\*With Gamma Ray

FIGURE 9-12. EXAMPLE OF AN ACOUSTIC CEMENT BOND LOG/MICROSEISMOGRAM, SHOWING INTERVALS OF GOOD BOND, POOR BOND, AND NO BOND (WELFEX, 1973, P. 87).

are limited to the uncased portion of a well, but radioactive logs have been used to locate a freshwater-saline water interface behind casing (Keys and MacCary, 1973).

## MONITORING WELLS

The subject of monitoring wells has been a controversial one in regulation of wastewater injection. Such wells are routinely used in shallow groundwater studies but are less frequently used in conjunction with wastewater injection, for reasons that will be examined.

At least three hydrogeologically different types of monitor wells can be and have been constructed, each with different objectives as shown below:

<u>Well Type</u>	<u>Objective</u>
1. Constructed in receiving aquifer--nondischarging	<ul style="list-style-type: none"> <li>a. Obtain geologic data</li> <li>b. Monitor pressure in receiving aquifer</li> <li>c. Determine rate and direction of wastewater movement</li> <li>d. Detect geochemical changes in injected wastewater</li> <li>e. Detect shifts in freshwater-saline water interfaces</li> </ul>
2. Constructed in or just above confining unit--nondischarging	<ul style="list-style-type: none"> <li>a. Obtain geologic data</li> <li>b. Detect leakage through confining unit.</li> </ul>
3. Constructed in a freshwater aquifer above receiving aquifer	<ul style="list-style-type: none"> <li>a. Obtain geologic data</li> <li>b. Detect evidence of freshwater contamination</li> </ul>

Monitor wells constructed in the receiving aquifer are normally non-discharging because a discharging well would defeat most of the purposes of this type of monitor well. Also, the produced brines would have to be disposed of. Although it is not normally necessary to monitor pressure in the receiving aquifer except at the injection well, special monitor wells may be desired where pressure at a distance from the injection well is of concern because of the presence of known or suspected faults or abandoned wells that may be inadequately plugged. The pressure response in a monitor well at such locations would indicate the extent of danger of flow through such breaches in the confining beds and possibly also indicate whether leakage was occurring.

Constructing a monitor well or wells in the receiving aquifer is the only direct means of verifying the rate and direction of wastewater movement. More than one well will frequently be necessary to meet this objective, because monitor wells of this type only sample wastewater plumes that pass directly through the well bore; and non-uniformity in aquifer porosity and per-

meability can cause the wastewater to arrive very rapidly or perhaps not at all at a particular well. A single well might be satisfactory where aquifer and fluid properties are such that it is judged most likely that wastewater movement will be radial and reasonably uniform or where the objective is to detect wastewater arrival at a particular point of interest. These same comments apply to wells intended to detect geochemical changes in injected wastewater. A difference is that a well for monitoring geochemical changes would be placed near enough to the injection well so that the wastewater front will arrive within a relatively short time, whereas, a well for detecting wastewater arrival at a point of concern might be beyond the expected ultimate travel distance of the wastewater.

A well intended to detect a shift in a freshwater-saline water interface should be located either within that interface or in the freshwater portion of the aquifer just beyond the interface. Because movement of this interface will be in response to increased aquifer fluid pressure, rather than to actual displacement by the wastewater front, detection of its movement should be possible with a small number of observation wells, perhaps even a single, properly located one. It is possible to estimate rates of movement for a particular case and to determine if a monitor well is likely to detect such a shift. Monitoring would be for confirmation of the calculations and to allow for revisions in regulation if unexpected results occur.

Negative factors should be considered in any case where deep monitor wells are contemplated: monitor wells in the receiving aquifer may be of limited usefulness, and they provide an additional means by which injected wastewater could escape from the receiving aquifer. In a number of cases, multiple injection wells have been constructed at a site, one or more of which may be standby injection wells. Standby wells can be used for monitoring of aquifer pressure, and for sampling of aquifer water. However, if they have been operated or even extensively tested, their use for monitoring may be impaired.

Some examples of the use of observation wells in the receiving aquifer are given by Goolsby (1971 and 1972), Kaufman (1973), Kaufman et. al. (1973), Leenheer and Malcom (1973), Peek and Heath (1973), and Hanby and Kidd (1973). Faulkner and Pascale (1975) updated the earlier reports by Goolsby and Kaufman to provide the most comprehensive and detailed example available of injection well monitoring.

For detection of leakage, the principal of using nondischarging monitor wells completed in the confining beds or in a confined aquifer immediately above the confining beds has been widely discussed but has been little used. This type of well has the potential for acting as a very sensitive indicator of leakage by allowing measurement of small changes in pressure (or water level) that accompany leakage. A well of this type is best suited for use where the confining unit is relatively thin and well-defined and where the engineering properties of the two aquifers are within a range such that pressure response in the monitored aquifer will be rapid if leakage occurs. Use of the concepts outlined by Witherspoon and Neuman (1972) will allow evaluation of the possibilities of success of this monitoring method in a specific situation. In many actual cases, confining beds are several hundred to several thousand feet thick and do not contain aquifers suitable for such monitoring. In other cases, the principal confining beds are amenable to water per-

itoring but several thousands of feet of interbedded aquitards and saline water aquifers are present; in these cases, slow vertical leakage across the aquitard immediately over the injection interval is not significant because it can be predicted that there will be no measurable influence at the stratigraphic level where freshwater or other resources occur.

Two good examples of the usefulness of monitoring an aquifer immediately above the confining beds are provided by Kaufman et. al. (1973) and Leenheer and Malcolm (1973). In the case described by Kaufman et. al., wastewater leakage from the lower Floridan aquifer through 150 feet of confining beds into the upper Floridan aquifer was detected by geochemical analysis of water from a monitor well constructed in the upper Floridan aquifer. No pressure effects were noticed in this instance. Leenheer and Malcolm summarized a case history in which leakage through the confining beds was detected first by pressure increase in an overlying aquifer, and later confirmed by chemical analysis which showed wastewater contamination of water in the aquifer.

The type of monitor well most commonly in use is that which is completed in a freshwater aquifer above the injection horizon for detecting freshwater contamination. In a number of locations, this type of monitoring is provided by wells that are a part of the plant's water supply system. In other cases, the wells have been constructed particularly for monitoring and are not used for water supply. Wells for detection of freshwater contamination should be discharging wells because they then sample an area of aquifer within their cone of depression. As previously mentioned, nondischarging wells are of limited value for detection of contamination because they sample only that water that passes through the well bore. Wells for monitoring freshwater contamination should be located close to the anticipated sources or possible routes of contamination, which are:

1. The injection well itself.
2. Other nearby deep wells, active or abandoned.
3. Nearby faults or fracture zones.

In the preceding discussion, it has been implied that separate wells would need to be constructed for surveillance of aquifers and aquicludes at different depths. This is not necessarily the case. Talbot (1972) shows how the injection well itself can be adapted for monitoring of overlying aquifers, and also how monitor wells may be constructed for surveillance of more than one aquifer. Wilson et. al (1973) describe a case where the injection well was modified as shown in Figure 9-13 for monitoring of two aquifers overlying the injection zone.

Since the objectives for each of the types of monitoring wells discussed are worthwhile ones, why are monitor wells not more widely used? The answer to this question is that the potential benefits are often judged to be small in comparison with the costs and negative aspects. Therefore, such wells may not be voluntarily constructed by the operating companies nor required by the regulatory agencies. In particular, monitor wells constructed in the receiving aquifer are often difficult to justify because such wells are the most

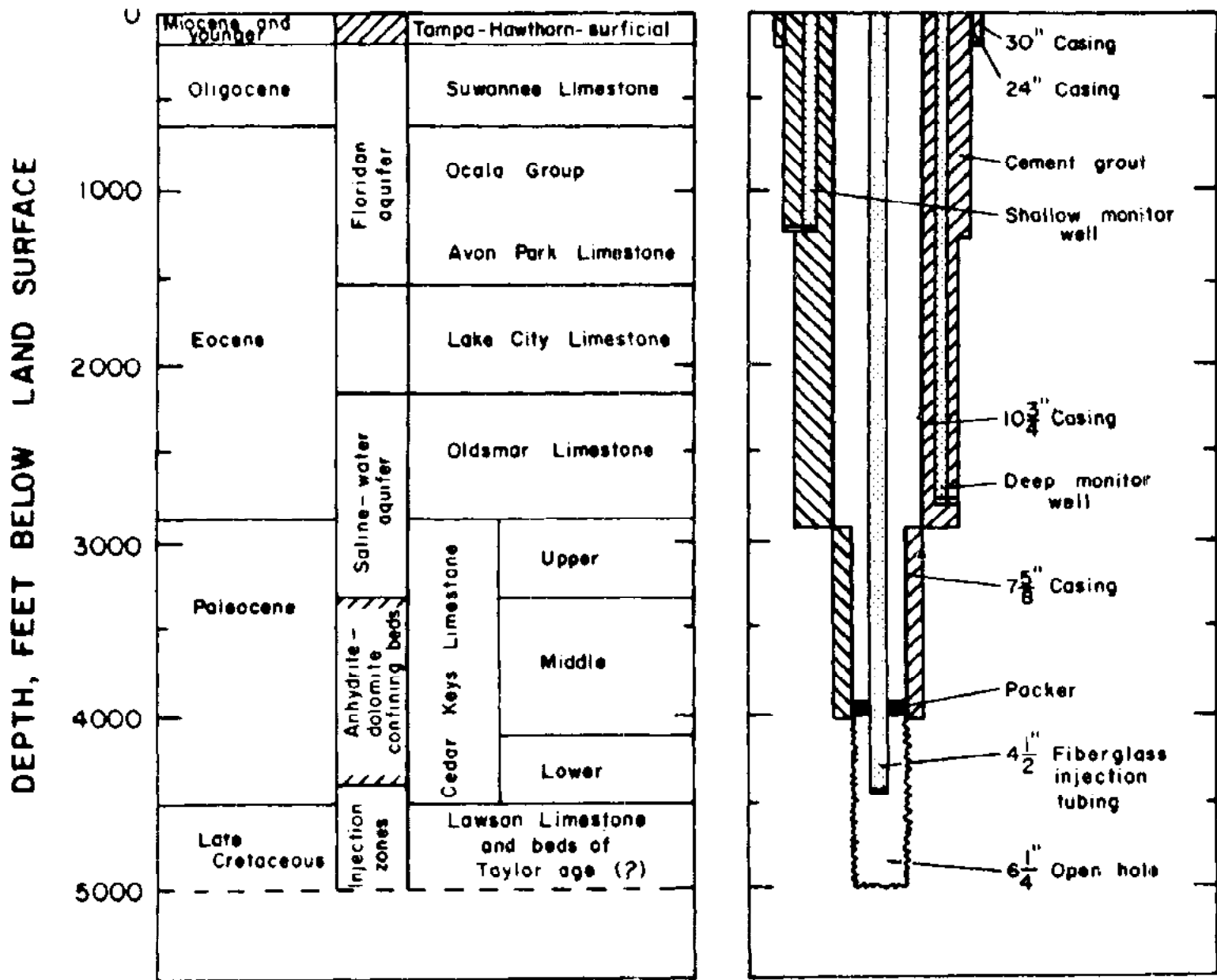

FIGURE 9-13. GEOLOGIC COLUMN AND CONSTRUCTION OF A WASTEWATER INJECTION WELL AT MULBERRY, FLORIDA, WHERE TWO AQUIFERS ABOVE THE INJECTION ZONE ARE MONITORED THROUGH THE INJECTION WELL (WILSON ET. AL., 1973).

expensive form of surveillance and may yield very little information that is important for regulation. It can reasonably be concluded that monitor wells should not be arbitrarily required, but should be used where local circumstances justify them.

#### OTHER MONITORING METHODS

A method of monitoring not so far mentioned is the sampling of springs, streams, or lakes that could be affected by injection. There are few instances where such monitoring would be applicable; but, for example, where springs originate along a fault within the area of pressure influence of the injection well an increase in discharge rate or change in water quality could be an indication of leakage of formation water along the fault in response to the increased pressure from injection. Also, springs and gaining streams act similarly to discharging wells in that they provide a composite sample of groundwater over their area of influence; thus, they might reveal leakage from unknown fracture zones or abandoned wells that connect a shallow groundwater aquifer with the injection interval. In a similar way, lakes may be collecting points for groundwater seepage or streams and may reflect quality changes in shallow groundwater aquifers.

Surface geophysical methods offer some limited possibilities for monitoring of wastewater injection. Barr (1973) discussed the feasibility of monitoring the distribution of injected wastewater with seismic reflection. Monitoring by seismic reflection depends on the existence of a sufficient density contrast between injected and interstitial water, and no field trials of monitoring by seismic reflection have been reported. Electrical resistivity surveying could be useful for monitoring the movement of freshwater-saline water interfaces or for detecting saline water pollution of freshwater aquifers. Recent articles concerning detection of groundwater contamination by resistivity surveying have been published by Stollar and Roux (1975), and Klefstad, et. al. (1975).

Monitoring for earthquake occurrence is accomplished by use of a network of seismometers placed in the vicinity of the injection well and in the vicinity of nearby faults along which seismic events might be triggered. Examples of this form of monitoring are described by Raleigh (1972) and by Hanby and Kidd (1973). In a case where earthquake stimulation is considered a possibility, seismic monitoring should begin before the well is operated to obtain background data.

#### State Monitoring Requirements

Walker and Cox (1976) indicate that regulatory provisions with regard to monitoring, like those concerning other elements of state control procedures, exhibit a wide range of variation. The range extends from complete absence of formal provisions to relatively detailed requirements concerning monitoring procedures, with the general provision for such monitoring as is required by the state regulatory agency falling somewhere in between. States with specific monitoring provisions include Florida, Colorado, Michigan, Nebraska, Oklahoma, and Texas.

The Florida Department of Pollution Control (1972) describes its state's injection well monitoring policy:

"Adequate monitoring systems in disposal and fresh water aquifers are required and shall be adequate to insure knowledge of migration and behavior of injected liquid wastes. Periodic reporting of the following shall be required:

- (1) Results of monitoring the volume, chemical quality, temperature, and other properties of the injected waste.
- (2) Results of continuously monitoring hydraulic pressures at the wellhead, in the annulus, in the injection aquifer, in the lowermost fresh water aquifer, and at other places when required.
- (3) Results of monitoring quality of water in the fresh water aquifers at springs and shallow observation wells and in the injection aquifer at deep observation wells near the injection well."

In Colorado, information submitted with an application for an injection well must include ". . . plans for monitoring injection pressures and formation pressures, i. e., injection wells and observation wells. (Colorado Department of Health, 1974). In addition, this state has two rather unique provisions contained therein: (the regulatory agency) may designate some third party to utilize the monitoring system data developed by or for the operation of the system." Also, regulations provide that "monitoring equipment shall be operated and precautionary steps shall be undertaken after termination or abandonment for as long as the regulatory agency may reasonably require which operation and steps shall be at the sole risk, cost, and expense of the person responsible for the disposal system."

Requirements of the other states mentioned previously are somewhat less extensive. The Michigan Department of Natural Resources (1972) requires monitoring of ". . . operating pressures, rates of injection, types and volumes of fluids injected or withdrawn, and other pertinent information. . ."

The Nebraska Department of Environmental Control (1975) requires monitoring of effluent quality, injection rate and pressure, and pressure in the casing-tubing annulus. The Oklahoma Water Resources Board (1973) requirements include chemical and physical nature of waste material, injected amount of waste material, density of waste (in pounds per cubic foot), injection-pump pressure, annular pressure between tubing and production casing, and pressure and fluid-quality reports from monitoring wells where required.

Although not contained in formal regulations, monitoring requirements in Texas have been described by the Texas Water Quality Board (1972):

"The Agency usually requires that a pressure gauge be installed on the wellhead for monitoring the pressure on the annulus between the injection tubing and the protection casing. Should a leak occur in the tubing or the packer seat, a pressure increase on the annulus during injection would be indicated by the gauge, and remedial action can be initiated to correct the malfunction. A gauge on the injection tubing is also required to monitor the surface injection pressure."



## CHAPTER 9

### REFERENCES

- Barr, F. J., Jr. "Feasibility Study of a Seismic Reflection Monitoring System for Underground Waste-Material Injection Sites." in Underground Waste Management and Artificial Recharge. Jules Braunstein, ed. 1973. pp. 207-218.
- Black, Crow, and Eidsness, Inc. Engineering Report on Modification to Deep-Well Disposal System: Effect of Monitoring Wells and Future Monitoring Requirements for Sugar Cane Growers' Cooperative of Florida, Belle Glade, Palm Beach County, Florida. Engr. Rept. Proj. No. 387-71-01. 1972. 40 pp.
- Bredehoeft, et. al. "Hydraulic Fracturing to Determine the Regional In-Site Stress Field, Piceance Basin, Colorado." Geol. Soc. of Amer. Bulletin. Vol. 87. 1976. pp. 250-258.
- Colorado Department of Health. "Rules for Subsurface Disposal Systems." January, 1974.
- Faulkner, G. L., and Pascale, C. A. "Monitoring Regional Effects of High Pressure Injection of Industrial Wastewater in a Limestone Aquifer." Ground Water. Vol. 13, No. 2. 1975. pp. 197-208.
- Fertl, W. H., et. al. "A Look at Cement Bond Logs." Journal of Petroleum Technology. Vol. 26. June, 1974. pp. 607-617.
- Florida Department of Pollution Control. "Revised Policy on Drainage and Injection Wells." Technical Memo No. B-12. issued June 1, 1972.
- Goolsby, D. A. "Geochemical Effects and Movement of Injected Industrial Waste in a Limestone Aquifer." in Underground Waste Management and Environmental Implications. T. D. Cook, ed. Amer. Assoc. of Petroleum Geologists Memoir 18. Tulsa, Oklahoma. 1972. pp. 355-367.
- Goolsby, D. A. "Hydrogeochemical Effects of Injecting Wastes into a Limestone Aquifer near Pensacola, Florida." Ground Water. Vol. 9, No. 1. 1971. pp. 13-19.
- Grossman, M., et. al. "A Sonic Method for Analyzing the Quality of Cementation of Borehole Casings." Journal of Petroleum Technology. February, 1961. pp. 165-171.

- Hanby, K. P., and Kidd, R. E. "Subsurface Disposal of Liquid Industrial Wastes in Alabama--A Current Status Report." in Underground Waste Management and Artificial Recharge. Jules Braunstein, ed. Amer. Assoc. Petroleum Geologists, Tulsa, Oklahoma. 1973. pp. 72-90.
- Kaufman, M. I. "Subsurface Wastewater Investigation, Florida." Amer. Soc. Civil Engineers Proc. Journal Irrigation and Drainage Div. Vol. 99, No. 1R1. 1973. pp. 53-70.
- Keys, W. S., and MacCary, L. M. Location and Characteristics of the Interface between Brine and Fresh Water from Geophysical Logs of Boreholes in the Upper Brazos River Basin, Texas. U. S. Geological Survey Prof. Paper 809-B. 1973. 23 pp.
- Klefstad, G., et. al. "Limitations of the Electrical Resistivity Method in Landfill Investigations." Ground Water. Vol. 13, No. 5. 1975. pp. 418-427.
- Leenheer, J. A., and Malcolm, R. L. "Case History of Subsurface Waste Injection of an Industrial Organic Waste." in Underground Waste Management and Artificial Recharge. Jules Braunstein, ed. Amer. Assoc. Petroleum Geologists, Tulsa, Oklahoma. 1973. pp. 565-584.
- McCullough Services. Casing Inspection/Casing Caliper Logging Service. McCullough Services, Houston, Texas. undated.
- Michigan Department of Natural Resources. "General Rules Governing Mineral Well Operations." June, 1972.
- Nebraska Department of Environmental Control. "Rules and Regulations for the Control of Disposal Wells to Protect Ground Water and Other Subsurface Resources of the State of Nebraska." June, 1975.
- Oklahoma Water Resources Board. "Rules and Regulations." Chapter V., Sec. 530. 1973.
- Peek, H. J., and Heath, R. C. "Feasibility Study of Liquid-Waste Injection into Aquifers Containing Salt Water, Wilmington, North Carolina." in Underground Waste Management and Artificial Recharge. Jules Braunstein, ed. Amer. Assoc. Petroleum Geologists. Tulsa, Oklahoma. 1973. pp. 851-878.
- Raleigh, C. B. "Earthquakes and Fluid Injection." in Underground Waste Management and Environmental Implications. T. D. Cook, ed. Amer. Assoc. of Petroleum Geologists Memoir 18. 1972. pp. 273-279.
- Schlumberger. Schlumberger Engineered Production Services. Schlumberger, Houston, Texas. 1970.
- Stollar, R. L., and Roux, P. "Earth Resistivity Surveys--A Method for Defining Groundwater Contamination." Ground Water. Vol. 13, No. 2. 1975. pp. 145-150.

- Talbot, J. S. "Requirements for Monitoring of Industrial Deep Well Disposal Systems." in Underground Waste Management and Environmental Implications. T. D. Cook, ed. Amer. Assoc. Petroleum Geologists Memoir 18. 1972. pp. 85-92.
- Texas Water Quality Board. "Subsurface Waste Disposal in Texas." Agency Publication No. 72-05. February, 1972.
- Walker, Terry. "A Full Wave Display of Acoustic Signal in Cased Holes." Journal of Petroleum Technology. 1963. pp. 17-22.
- Walker, W. R., and Cox, W. E. Deep Well Injection of Industrial Wastes: Government Controls and Legal Constraints. Virginia Water Resources Research Center, Blacksburg, Virginia. 1976. 163 pp.
- Warner, D. L. Deep-Well Injection of Liquid Waste. U. S. Dept. of Health, Education, and Welfare, Public Health Service Publication No. 99-WP-21. 1965. 55 pp.
- Welex. "Services." Service Memoranda 3. Welex, Houston, Texas. 1973.
- Wilson, W. E., et. al. "Hydrologic Evaluation of Industrial-Waste Injection at Mulberry, Florida." in Underground Waste Management and Artificial Recharge. Jules Braunstein, ed. Amer. Assoc. Petroleum Geologists, Tulsa, Oklahoma. 1973. pp. 552-564.
- Witherspoon, P. A., and Neuman, S. P. "Hydrodynamics of Fluid Injection." in Underground Waste Management and Environmental Implications. T. D. Cook, ed. Amer. Assos. Petroleum Geologists Memoir 18. Tulsa, Oklahoma. 1972.
- Zemanek, Joe, et. al. "Formation Evaluation by Inspection with the Borehole Televiewer." Geophysics. Vol. 35, No. 2. 1970. pp. 254-269.

## CHAPTER 10

### INJECTION WELL ABANDONMENT

Injection wells can be categorized according to their state of use or non-use. In Table 1-1, Chapter 1, the categories of drilled wells include: (1) drilled, but never used; (2) operating; (3) not operating, but unplugged; and (4) not operating and plugged. All wells will eventually be permanently removed from use for technical, economic or regulatory reasons. When a well is permanently removed from use, it is plugged. A well that has been plugged is considered abandoned. This chapter discusses the procedures for injection well abandonment.

Abandonment may occur after many years of successful operation merely because the well is no longer needed. At the other extreme, wells are occasionally abandoned during construction, before there has ever been any injection, because of damage to the well or adverse geologic conditions. Usually, however, the process of abandoning an injection well is thought of as beginning when injection is permanently stopped. Because it is possible that a well may need to be abandoned at any time, as a result of unforeseen circumstances, Rudd (1972) recommends that tentative abandonment plans be made before injection begins.

Normally, abandonment consists of shutting-in a well, allowing some of the built-up reservoir pressure to decline, and then plugging the well with the appropriate materials. In some unusual cases, it might be desired to remove injected wastewater before plugging, either to reduce the reservoir pressure more rapidly and/or to remove pollutants from the subsurface. An additional objective that has been suggested for wastewater removal is the recovery of valuable components from the previously injected wastewater. So far as is known, there has never been any extensive removal of injected wastewater prior to abandonment for any of these purposes. However, if the need to remove injected wastewater is considered a possibility, then a plan for storing or disposing of the pumped wastewater should be available.

The purpose of plugging any deep well is to prevent mixing of fluids from different geologic levels through an open well or hole, to prevent flow of fluids from pressurized zones to the surface, and to maintain existing pressures in the individual subsurface intervals. In the case of wastewater injection wells, the principal objective is to provide for containment of the injected waste within the interval selected for that purpose. However, complete segregation of all water-bearing intervals should be achieved at the same time.

Rudd (1972) has suggested that wells should not be plugged immediately so that they may be left open for observation until pressures have equalized at a safe level and until the potentially harmful characteristics of the effluent have been attenuated. It would probably always be desirable to wait for the reservoir pressure to decline to its preoperational level, or nearly so, before plugging. However, the amount of pressure fall-off that is actually achieved before plugging will be quite variable, since there may or may not be other operating wells in the immediate vicinity, and there can be an urgent need to proceed with the plugging of a well that has experienced an engineering failure.

There probably are some wastewaters that, as Rudd (1972) suggests, should be observed until their harmful characteristics have been attenuated before the injection well is plugged. However, many wastewaters will change little, if any, with time and there are others whose chemical character is such that any changes would be unimportant. Therefore, this observational procedure should be applied only where it will yield significant information.

In spite of the extensive number of wells of all types that are plugged each year, there is little published information concerning plugging, except in the state regulations. States with extensive oil and gas resources have long had regulations concerning the abandonment and plugging of deep wells. Many states have regulations concerning abandonment of water wells and other shallow holes, such as shot holes for seismic exploration. In most states, abandonment procedures for wastewater injection wells, if regulated, are regulated by oil and gas agencies which permit and control abandonment of all deep wells.

In a few states, injection wells are specifically covered by laws, regulations, or rules, in which abandonment requirements are included. Walker and Cox (1976) provide a summary of the abandonment requirements for injection wells in Michigan, Nebraska, Ohio, Oklahoma, and Texas. According to Walker and Cox (1976), the following requirements, in effect in Oklahoma, appear to be the most comprehensive:

The owner and/or operator of any industrial disposal well shall be jointly and individually liable and responsible for the proper plugging of said well.

The owner and/or operator of any disposal well not in operation for a period of six (6) months must either apply for a new permit as specified in Item 10.6 above or immediately plug the well.

Any well to be permanently abandoned shall be immediately plugged.

The owner and/or operator of a disposal well shall notify Oklahoma Water Resources Board of his intention to plug. Written notification shall be received at least ten (10) days prior to the commencement of plugging operations.

The staff of Oklahoma Water Resources Board shall be given the opportunity to be present at plugging operations. The plugging operator shall notify the Oklahoma Water Resources Board of the exact time during which all plugging operations will take place.

Every well shall be plugged in such a manner as to permanently prevent the migration of any disposed substances out of the disposal zone, as well as the migration of oil, gas, or salt water into or out of any productive formations, by means of the well bore. Plugging shall also seal off all fresh ground water strata encountered in the well so as to prevent the entrance of salt water or the escape of fresh ground water by means of the well bore.

Before any casing is removed from a well, all liquids shall be removed or displaced and the well filled with mud. As the casing is removed, the well shall be kept filled with mud.

Any uncased hole below the shoe of any casing to be left in the well shall be filled with cement to a depth of at least fifty (50) feet above the shoe of the casing. If the well is completed with a screen or liner and the screen or liner is not removed, the well bore shall be filled with cement at least fifty (50) feet above the screen or liner.

Whenever production casing is severed and removed, the well bore shall be cemented from a point fifty (50) feet below to a point fifty (50) feet above the point of severance; provided that, if after such cement plug has been set, the same string of casing is again severed in the process of removal, further cementing thereof shall not be required.

All fresh water zones encountered in the well shall be sealed off and protected by adequate casing extending from a point at least fifty (50) feet below the base of the lowest freshwater zone to within three (3) feet of the top of the well bore, and by completely filling the annular space behind such casing with cement. If the surface or other casing in the well meets these requirements, a cement plug may be set at least fifty (50) feet below the shoe of the casing. If the casing and cement behind the casing do not meet the requirements of this subsection, the well bore shall be filled with cement

from a point fifty (50) feet below the base of the lowest fresh-water zone to a point fifty (50) feet above the shoe of the surface casing. The well bore shall, in all events, be filled with cement from a point three (3) feet below ground surface to a point thirty-three (33) feet below ground surface.

All intervals between cement plugs in the well bore shall be filled with mud.

Any "rat" or "mouse hole" used in the drilling of a well with rotary tools shall be filled with mud to a point eight (8) feet below ground level and with cement from such point to a point three (3) feet below ground level, and filled in with earth above the top of the cement.

The top of the plug of any plugged well shall show clearly, by permanent markings, whether inscribed in the cement, or on a steel plate embedded in the cement, the well number and date of plugging.

Within fifteen (15) days after a well has been plugged, the owner or operator shall file a plugging record, in duplicate, with the Oklahoma Water Resources Board. If there is not a complete and correct log of the well on file with the Board, then the owner at the time of plugging shall furnish and file a complete and correct log thereof, or the best information available. The well bond will be released only when the requirements of this rule have been met.

Although the requirements of other states differ in detail, the Oklahoma rules can be regarded as generally similar to rules or regulations found elsewhere. Detailed suggestions for the abandonment of water wells and test holes are given in the recently published "Manual of Water Well Construction Practices" (U. S. Environmental Protection Agency, 1975), which was prepared by the National Water Well Association.

Plugging procedures in well abandonment differ greatly. Historically, plugging has evolved from the driving of a "seasoned wooden plug" into the well bore at the surface to requirements for the emplacement of cement plugs and mud as described in the Oklahoma rules. In addition, existing state abandonment regulations often allow removal of casing from a well before plugging but require the cutting-off of any remaining casing below the ground. In contrast with these provisions, which were developed for the oil industry, it is frequently stated in the literature that wastewater injection wells should be plugged from the bottom to the surface with cement (Van Everdingen and Freese, 1971; Rudd, 1972; Ohio River Valley Water Sanitation Commission, 1973). Whether casing should be removed or not depends on the method of well construction. If all casing is cemented from bottom to top,

as is usually the case today, then no casing will be removed prior to plugging. Surface casing should always be completely cemented when it is installed, and it should never be removed. If intermediate and injection strings of casing are not completely cemented during installation, then it is recommended that they be pulled, perforated, slotted, or ripped, so that cement can be emplaced in the annular space between the casing and the borehole wall, particularly adjacent to permeable intervals. The purpose of cutting off casing below the ground is to avoid interference with agriculture and other land use. Because it may be important to accurately locate an abandoned wastewater injection well at some time in the future, the Ohio River Valley Water Sanitation Commission (1973) recommends that a permanent surface monument be established. As far as is known, this recommendation has not been implemented by any state, but it is believed to be worthy of consideration.

Wells that are abandoned during construction will vary so much in their character that an individual abandonment procedure will need to be developed for each well. Therefore, no general recommendations for the abandonment of such wells are suggested.

The regulatory procedure for abandonment should include:

1. Approval of abandonment plan by the regulatory agency.
2. Witnessing of plugging by a representative of the regulatory agency.
3. Filing of abandonment and plugging report by the well operator.

The Ohio River Valley Water Sanitation Commission (1973) provides sample forms of an application for an injection well abandonment permit (Figure 10-1) and of a plugging and abandonment report (Figure 10-2).



I. Well operator:

1. Name \_\_\_\_\_
2. Address \_\_\_\_\_
3. City \_\_\_\_\_
4. Waste injection well permit number \_\_\_\_\_

II. Detailed description of proposed plugging procedure (attach additional sheets if necessary) \_\_\_\_\_

III. Planned date and time of plugging: \_\_\_\_\_

IV. Present well status:

1. Total volume of waste injected \_\_\_\_\_
2. Present injection rate \_\_\_\_\_
3. Present injection pressure (well-head) \_\_\_\_\_
4. Present well shut-in pressure \_\_\_\_\_

V. Plugging operations will be conducted by:

1. Name of Company \_\_\_\_\_
2. Address \_\_\_\_\_
3. City \_\_\_\_\_ State \_\_\_\_\_

Signature of Authorized Representative of Operator \_\_\_\_\_ Date \_\_\_\_\_

1. Application for a permit to plug and abandon shall be filed at least 30 days in advance of planned date of operation.
2. The planned date and time of plugging should be specific and the operation must be witnessed by a representative of the \_\_\_\_\_ (State regulatory agency)

FIGURE 10-1. APPLICATION FOR PERMIT TO PLUG AND ABANDON A WELL (ORSANCO-1973)

I. WELL OPERATOR:

Name \_\_\_\_\_

Address \_\_\_\_\_

Waste injection well permit number \_\_\_\_\_

II. DESCRIPTION OF PLUGGING: (add additional sheets if necessary)

Plug materials -- type and volume	Depth	
	From	To (feet)
_____	_____	_____
_____	_____	_____
_____	_____	_____
_____	_____	_____

III. FINAL STATUS

Total volume of waste injected \_\_\_\_\_ as of \_\_\_\_\_ (date)

Final well shut-in pressure \_\_\_\_\_

Estimated horizontal extent of injected waste \_\_\_\_\_

IV. ASSOCIATED WORK

Pits and excavations filled ( ) yes

Equipment and debris removed ( ) yes

Permanent monument emplaced ( ) yes

Executed this \_\_\_\_\_ day of \_\_\_\_\_, 19 \_\_.

State of \_\_\_\_\_ County of \_\_\_\_\_

\_\_\_\_\_  
(Signature of affiant)

\_\_\_\_\_  
(Typewritten name and title)

(Continued)

FIGURE 10-2. PLUGGING INFORMATION AND ABANDONMENT AFFIDAVIT (ORSANCO-1973)

Figure 10-2. Continued

On this \_\_\_\_\_ day of \_\_\_\_\_, 19 \_\_, before me appeared \_\_\_\_\_, known to me to be the person whose name is subscribed to the above instrument, who being by me duly sworn in oath, states that he is authorized to make the above report and that he has knowledge of the facts stated therein, and that said report is true and correct.

SEAL

My commission expires \_\_\_\_\_

\_\_\_\_\_  
(Notary Public)

Plugging witnessed by \_\_\_\_\_  
Authorized state representative

## REFERENCES

### CHAPTER 10

- Ohio River Valley Water Sanitation Commission. Underground Injection of Waste-Waters in the Ohio Valley Region. ORSANCO, Cincinnati, Ohio. 1973.
- Rudd, Heilson. Subsurface Liquid Waste Disposal and its Feasibility in Pennsylvania. Pennsylvania Bureau of Topographic and Geologic Survey. Environmental Geology Report 3. 1972. 103 pp.
- U. S. Environmental Protection Agency. Manual of Water Well Construction Practices. EPA-570/9-75-001. U. S. Gov't. Printing Office, Washington, D. C. 1976. 156 pp.
- Van Everdingen, R. O., and Freese, R. A. Subsurface Disposal of Waste in Canada. Inland Waters Branch, Department of the Environment Technical Bulletin No. 49. 1971. 64 pp.
- Walker, W. R., and Cox, W. E. Deep Well Injection of Industrial Wastes: Government Controls and Legal Constraints. Virginia Water Resources Research Center, Blacksburg, Virginia. 1976. 163 pp.

## GLOSSARY

**abandoned well:** A well whose use has been permanently discontinued or which is in a state of disrepair such that it cannot be used for its intended purpose or for observation purposes.

**acidizing:** The injection of acid through the borehole or well into a carbonate or sandstone formation to effect an increase of permeability and porosity by dissolving the acid soluble portion of the rock constituents. Frequently used with hydraulic fracturing methods.

**aeration:** The mechanism by which air and liquid are brought into close contact. This can be accomplished by one or more of the following methods:  
(a) spraying the liquid in the air (b) bubbling air through the liquid  
(c) agitating the liquid to promote surface absorption of air.

**aquiclude:** A body of relatively impermeable rock that is capable of absorbing water slowly, but functions as an upper or lower boundary of an aquifer and does not transmit ground water rapidly enough to supply a well or spring.

**aquifer:** A porous, permeable, water-bearing geologic body of rock. Generally restricted to materials capable of yielding an appreciable amount of water.

**aquitard:** A confining bed that retards but does not prevent the flow of water to or from an adjacent aquifer; a leaky confining bed. It does not readily yield water to wells or springs, but may serve as a storage unit for ground water.

**arkose:** A feldspar-rich, typically coarse-grained sandstone, commonly pink or reddish to pale gray or buff, composed of angular to subangular grains that may be either poorly or moderately well sorted, usually derived from the rapid disintegration of granite or granitic rocks (including high-grade feldspathic gneisses and schists), and often closely resembling or having the appearance of a granite.

**artesian:** An adjective referring to ground water confined under sufficient hydrostatic pressure to rise above the upper surface of the aquifer.

**artesian aquifer:** Confined aquifer.

**artesian basin:** A terrane, often, but not necessarily basin-shaped, including an artesian aquifer whose potentiometric surface typically is above the land surface in the topographically lower portion of the terrane. Examples range in size from areas a few hundred feet across to several hundred miles across.

**baffles:** Deflector vanes, guides, grids, gratings, or similar devices constructed or placed in flowing water or wastewater systems to check or affect a more uniform distribution of velocities; adsorb energy; divert, guide, or agitate the liquids; and check eddies.

**biological wastewater treatment:** Forms of wastewater treatment in which bacterial or biochemical action is intensified to stabilize, oxidize, and nitrify the unstable organic matter present. Intermittent sand filters, contact beds, trickling filters, and activated sludge processes are examples.

**BOD:** The abbreviation for biochemical oxygen demand. The quantity of oxygen used in the biochemical oxidation of organic matter in a specified time, at a specified temperature, and under specified conditions. Also, a standard test used in assessing required wastewater treatment.

**brine:** Concentrated salt solution remaining after removal of distilled product; also, concentrated brackish saline or sea waters containing more than 100,000 mg/l of total dissolved solids.

**capillary conductivity:** The ability of an unsaturated soil or rock to transmit water or another liquid. As the larger interstices are partly occupied by air or other gas, rather than a liquid, the liquid must move through and in bodies surrounding point contacts of rock or soil particles. For water, the conductivity increases with the moisture content, from zero in a perfectly dry material to a maximum equal to the hydraulic conductivity, or effective permeability at 100% water saturation.

**capillary head:** The capillary potential expressed as head of water.

**capillary potential:** A number representing the work required to move a unit of mass of water from soil or rock to an arbitrary reference location and energy state (SSSA, 1965, p. 348). Symbol: M.Cf: capillary head.

**cement:** Chemically precipitated mineral material that occurs in the spaces among the individual grains of a consolidated sedimentary rock, thereby binding the grains together as a rigid coherent mass; it may be derived from the sediment or its entrapped waters, or it may be brought in by solution from outside sources. The most common cements are silica (quartz, opal, chalcedony), carbonates (calcite, dolomite, siderite), and various iron oxides; others include barite, gypsum, anhydrite, and pyrite. Clay minerals and other fine clastic particles should not be considered as cements.

**cementation:** The diagenetic process by which coarse clastic sediments become lithified or consolidated into hard, compact rocks through the deposition or precipitation of minerals in the spaces among the individual grains of the sediment. It may occur simultaneously with sedimentation, or the cement may be introduced at a later time. Cementation may occur by secondary enlargement. Syn: agglutination.

**cementing:** The operation whereby a cement slurry is pumped into a drill hole and/or forced behind the casing for such purposes as: sealing the casing to the walls of the hole; preventing unwanted leakage of fluids into the hole or migration of liquids or gas into or out of the hole; closing the hole back to a shallower depth; sealing a dry hole; or re-drilling to straighten the hole; and plugging and abandonment.

**centipoise:** A unit of viscosity based on the standard of water at 20° C., which has a viscosity of 1.005 centipoises.

**CGS system:** A metric system of physical measurements in which the fundamental units of length, mass, and time are the centimeter, the gram, and the mean solar second.

**chelating agent:** A chemical or complex which causes an ion, usually a metal, to be joined in the same molecule by both ordinary and coordinate valence forces. Such linkages result in the formation of one or more heterocyclic rings in which the metal atom is part of the ring. Commercially available chelating agents may be used to remove traces of metal ions in industrial and biological processes.

**chemical oxygen demand (COD):** A measure of the oxygen-consuming capacity of inorganic and organic matter present in water or wastewater. It is expressed as the amount of oxygen consumed from a chemical oxidant in a specific test. It does not differentiate between stable and unstable organic matter and thus does not necessarily correlate with biochemical oxygen demand.

**chemical precipitation:** Precipitation induced by addition of chemicals.

**chemical treatment:** Any process involving the addition of chemicals to obtain a desired result.

**clay minerals:** One of a complex and loosely defined group of finely crystalline, meta colloidal, or amorphous hydrous silicates essentially of aluminum with a monoclinic crystal lattice of the two or three layer type in which silicon and aluminum ions have tetrahedral coordination in respect to oxygen. Clay minerals are formed chiefly by chemical alteration or weathering of primary silicate minerals such as feldspars, pyroxenes, and amphiboles and are found in clay deposits, soils, shales, and mixed with sand grains in many sandstones. They are characterized by small particle size and ability to adsorb substantial amounts of water and ions on the surfaces of the particles. The most common clay minerals belong to the kaolin, montmorillonite, and illite groups.

**coagulation:** The destabilization and initial aggregation of colloidal and finely divided suspended matter by the addition of a floc-forming chemical or by biological processes.

**compressibility:** The reciprocal of bulk modulus of elasticity. Its symbol is  $\beta$ . Syn: modulus of compression.

concentration: (1) The amount of a given substance dissolved in a unit volume of solution. (2) The process of increasing the dissolved solids per unit volume of solution, usually by evaporation of the liquid.

concentration tank: A settling tank of relatively short detention period in which sludge is concentrated by sedimentation or floatation before treatment, dewatering, or disposal.

conductivity bridge: A device which provides a means of measuring conductivity, whereby a conductivity cell forms one arm of a Wheatstone Bridge, a standard fixed resistance forms another arm, and a calibrated slide wire resistance with end coils provides the remaining two arms. A high-frequency alternating current is supplied to the bridge.

confined aquifer: An aquifer bounded above and below by impermeable beds or beds of distinctly lower permeability than that of the aquifer itself; an aquifer containing confined ground water.

confined ground water: A body of ground water overlain by material sufficiently impervious to sever free hydraulic connection with overlying ground water except at the intake. Confined water moves in conduits under the pressure due to difference in head between intake and discharge areas of the confined water body.

confining bed: A body of impermeable or distinctly less permeable material stratigraphically adjacent to one or more aquifers. Cf: aquitard; aquifuge; aquiclude.

core barrel: (a) A hollow tube or cylinder above the bit of a core drill, used to receive and preserve a continuous section or core of the material penetrated during drilling. The core is recovered from the core barrel. (b) The tubular section of a corer, in which ocean-bottom sediments are collected either directly in the tube or in a plastic liner placed inside the tube.

core bit: A hollow, cylindrical drill bit for carving, removing, and holding a core or sample of rock or soil material from the drill hole; the cutting end of a core drill. Syn: coring bit.

core drill: (a) A drill (usually a rotary drill, rarely a cable-tool drill) that cuts, removes, and brings to the surface a cylindrical rock sample (core) from the drill hole. It is equipped with a core bit and a core barrel. (b) A lightweight, usually mobile drill that uses drill tubing instead of drill pipe and that can (but need not) core down from grass roots.

core drilling: Drilling with a core drill; the act or process of obtaining a core by drilling. Syn: coring.



corrosion: The gradual deterioration or destruction of a substance or material by chemical action, frequently induced by electrochemical processes. The action proceeds inward from the surface.

cuttings: Rock chips or fragments produced by drilling and brought to the surface. The term does not include the core recovered from core drilling. Also: well cuttings; sludge; drillings. Syn: drill cuttings.

darcy: A standard unit of permeability, equivalent to the passage of one cubic centimeter of fluid of one centipoise viscosity flowing in one second under a pressure differential of one atmosphere through a porous medium having an area of cross-section of one square centimeter and a length of one centimeter. A millidarcy is one one-thousandth of a darcy.

Darcy's law: A derived formula for the flow of fluids on the assumption that the flow is laminar and that inertia can be neglected. The numerical formulation of this law is used generally in studies of gas, oil, and water production from underground formations.

degasification: The removal of a gas from a liquid medium. In water treatment, the removal of oxygen from water to lessen its corrosion potential. This may be accomplished by mechanical methods, chemical methods, or a combination of both.

diatomaceous earth: A fine, siliceous earth consisting mainly of the skeletal remains of diatoms (unicellular animals).

diatomaceous earth filter: A filter used in water treatment, in which a built-up layer of diatomaceous earth serves as the filtering medium.

dissolved oxygen: The oxygen dissolved in water, wastewater, or other liquid, usually expressed in milligrams per liter, parts per million, or percent of saturation. Abbreviated DO.

dissolved solids: The anhydrous residues of the dissolved constituents in water, or the sum of the dissolved constituents.

distillation: A process of evaporation and re-condensation used for separating liquids into various fractions according to their boiling points or boiling ranges.

drilling fluid: A heavy suspension, usually in water but sometimes in oil, used in rotary drilling, consisting of various substances in a finely divided state (commonly bentonitic clays and chemical additives such as barite), introduced continuously down the drill pipe under hydrostatic pressure, out through openings in the drill bit, and back up in the annular space between the pipe and the borehole walls and to a surface pit where cuttings are removed. The fluid is then reintroduced into the pipe. It is used to lubricate and cool the bit, to carry the cuttings up from the bottom, and to prevent sloughing and cave-ins by plastering and consolidating the walls with a clay lining, thereby making casing unnecessary during drilling, and also offsetting pressures of fluid in the formation that may exist in the case of an over-pressured

drill-stem test: A procedure for determining productivity of an oil or gas well by measuring reservoir pressures and flow capacities while the drill pipe is in the hole and the well is full of drilling mud. A drill stem test may be done in a cased or uncased hole.

effective porosity: The measure of the total volume of interconnected void space of a rock, soil or other substance. Effective porosity is usually expressed as a percentage of the bulk volume of material occupied by the interconnected void space.

effective stress: The average normal force per unit area transmitted directly from particle to particle of a soil or rock mass. It is the stress that is effective in mobilizing internal friction. In a saturated soil, in equilibrium, the effective stress is the difference between the total stress and the neutral stress of the water in the voids; it attains a maximum value at complete consolidation of the soil.

emulsion: A heterogeneous mixture of two or more liquids not normally dissolved in one another, but held in suspension one in the other by forceful agitation or by emulsifiers which modify the surface tension of the droplets to prevent coalescence.

emulsifying agent: A compound which enhances the strength of the interfacial film around the droplets of the dispersed liquid by providing layers of electrical charges, thus increasing the stability of emulsions. Stability is created because finely divided droplets are prevented from coalescing into large droplets.

facies: A term used to refer to a distinguished part or parts of a single geologic entity, differing from other parts in some general aspect; e. g., any two or more significantly different parts of a recognized body of rock or stratigraphic composition. The term implies physical closeness and genetic relation or connection between the parts.

facies change: A lateral or vertical variation in the lithologic or paleontologic characteristics of contemporaneous sedimentary deposits. It is caused by, or reflects, a change in the depositional environment.  
Cf: facies evolution.

facies contour: The trace (on a map) of a vertical surface that cuts a three-dimensional rock body into facies segments; a line indicating equivalence in lithofacies development.

facies map: A broad term for a stratigraphic map showing the gross areal variation or distribution (in total or relative content) of observable attributes or aspects of different rock types occurring within a designated stratigraphic unit, without regard to the position or thickness of individual beds in the vertical succession; specif. a lithofacies map. Conventional facies maps are prepared by drawing lines of equal magnitude through a field of numbers representing the observed values of the measured rock attributes. Cf: vertical-variability map.

- fault:** A surface or zone of rock fracture along which there has been displacement, from a few centimeters to a few kilometers.
- filtrate:** The liquid which has passed through a filter.
- filtration:** The process of passing a liquid through a filtering medium (which may consist of granular material, such as sand, magnetite, or diatomaceous earth, finely woven cloth, unglazed porcelain, or specially prepared paper). for the removal of suspended or colloidal matter.
- fishing tools:** The specialized equipment used for searching for and attempting to recover a piece or pieces of drilling equipment (such as sections of pipe, cables, or casing) that has become detached, broken or lost from a drilling tool and left or that has been accidentally dropped into the borehole.
- floc:** Small masses, commonly gelatinous, formed in a liquid by the reaction of a coagulant, through biochemical processes, or by agglomeration.
- flocculation:** The agglomeration of colloidal and finely divided suspended matter after coagulation by gentle stirring either by mechanical or hydraulic means.
- flotation:** The raising of suspended matter to the surface of the liquid in a tank as scum - by aeration, the evolution of gas, chemicals, electrolysis, heat, or bacterial decomposition - and the subsequent removal of the scum by skimming.
- flow rate:** The volume per time unit given to the flow of water or other liquid substance which emerges from an orifice, pump, turbine or passes along a conduit or channel, usually expressed as cubic feet per second (cfs), gallons per minute (gpm) or million gallons per day (mgd).
- fluid potential:** With reference to ground water, the mechanical energy per unit mass of a fluid (here, water) of any given point in space and time, with respect to an arbitrary state and datum. At a given point in a body of liquid, the fluid potential is proportional to the head; it is the head multiplied by the acceleration due to gravity.
- formation:** A body of rock characterized by a degree of lithologic homogeneity; it is prevailingly, but not necessarily, tabular and is mappable on the earth's surface or traceable in the subsurface.
- formation water:** Water present in a water-bearing formation under natural conditions as opposed to introduced fluids, such as drilling mud.
- geophysical logs:** The records of a variety of logging tools which measure the geophysical properties of geologic formations penetrated and their contained fluids. These properties include electrical conductivity and resistivity, the ability to transmit and reflect sonic energy, natural radioactivity, hydrogen ion content, temperature, gravity, etc. These

geophysical properties are then interpreted in terms of lithology, porosity, fluid content and chemistry.

geothermal gradient: The rate of increase of temperature in the earth with depth. The gradient near the surface of the earth varies from place to place depending upon the heat flow in the region and on the thermal conductivity of the rocks. The approximate geothermal gradient in the earth's crust is about 25°C/km.

gravity prospecting: The determination of specific gravity differences of rock masses by mapping the force of gravity of an area, using a gravimeter. Syn: gravitational method.

gravity separation: A separation process by which an oil and water mixture is allowed to separate into two phases, with the lighter oil phase rising to the surface of the heavier water phase.

group: General: An association of any kind based upon some feature of similarity or relationship. Stratig: Lithostratigraphic unit consisting of two or more formations; more or less informally recognized succession of strata too thick or inclusive to be considered a formation; subdivisions of a series.

grout: A cementitious component of high water content, fluid enough to be poured or injected into spaces such as fissures surrounding a well bore and thereby filling or sealing them. Specifically a pumpable slurry of portland cement, sand, and water forced under pressure into a borehole during well drilling to seal crevices and prevent the mixing of ground water from different aquifers.

hardness (water): A property of water causing formation of an insoluble residue when used with soap and causing formation of a scale in vessels in which water has been allowed to evaporate. It is primarily due to the presence of calcium and magnesium ions but also to ions of other alkali metals. Incrustation caused by the precipitation of carbonate minerals in hard water frequently will cause well screens and areas of the rock formation around the well to clog, resulting in a reduction of fluid flow into or out of the well. Hardness of water is generally expressed as parts per million  $\text{CaCO}_3$ , also milligrams per liter.

hydraulic conductivity: Ratio of flow velocity to driving force for viscous flow under saturated conditions of a specified liquid in a porous medium.

hydraulic head: (a) The height of the free surface of a body of water above a given subsurface point (b) The water level at a point upstream from a given subsurface point downstream (c) The elevation of the hydraulic grade line at a given point above a given point of a pressure pipe.

image-well theory: The effect of a barrier boundary on the drawdown in a well, as a result of pumping from another well, is the same as though the aquifer were infinite and a like discharging well were located across the real boundary on a perpendicular thereto and at the same distance from the boundary as the real pumping well.

injection schedule: A timetable for the disposal of liquid waste in an injection well. This timetable is based on the characteristics of the waste liquid, i. e., viscosity, temperature, chemistry, reactivity, etc.; the injection rate; and the physical characteristics of the receiving formation.

injection well: (a) A recharge well. (b) A well into which water or a gas is pumped for the purpose of increasing the yield of other wells in the area. (c) A well used to dispose of fluids in the subsurface environment by allowing it to enter by gravity flow, or injection under pressure.

interstice: An opening or space in a rock or soil that is not occupied by solid matter.

interstitial water: Water contained in the interstices of rocks. It may or may not be connate water. The origin of the water is not specified.

ion exchange: A chemical process involving reversible interchange of ions between a liquid and a solid or a liquid and a liquid, but no radical change in structure of the solid.

isopach: A line drawn on a map through points of equal thickness of a designated stratigraphic unit or group of stratigraphic units.

isopach map: A map that shows the thickness of a bed, formation or other tabular body throughout a geographic area; a map that shows the varying true thickness of a designated stratigraphic unit or group of stratigraphic units by means of isopachs plotted normal to the bedding or other bounding surface at regular intervals.

jetting: (a) A method of well construction where the casing is sunk by driving while the material inside is washed out by a water jet and carried to the top of the casing (b) A method of inserting well points by means of a water jet.

liner casing: Any string of casing whose top is situated at any point below the surface.

lithology: (a) The description of rocks on the basis of such characteristics as color, structures, mineralogic composition, and grain size. (b) The physical character of a rock.

magnetic survey: Measurement of a component or element of the geomagnetic field at different locations. It is usually made to map either the broad patterns of the Earth's main field or local anomalies due to variation in rock magnetization. Also: aeromagnetic survey.

mechanical agitation: The mixing of liquids, including introduction of atmospheric oxygen into a liquid by the mechanical action of a paddle, paddle-wheel, spray, or turbine mechanism.

- member: A division of a formation, generally of distinct lithologic character or of only local extent. A specially developed part of a varied formation is called a member, if it has considerable geographic extent. Members are commonly, though not necessarily, named.
- millidarcy: The customary unit of fluid permeability, equivalent to 0.001 darcy. Abbrev: md.
- mud logs: The record of continuous analysis of a drilling mud or fluid for oil and gas content.
- neutralization: Reaction of acid or alkali with the opposite reagent until the concentrations of hydrogen and hydroxyl ions in the solution are approximately equal.
- oil-field brine: Connate waters encountered during drilling rocks at depth. These waters usually have a high concentration of calcium and sodium salts and a dominance of chloride ion.
- organic chemicals: Chemical substances of animal or vegetable origin, or more correctly, of basically carbon structure, comprising compounds consisting of hydrocarbons and their derivatives.
- oxidation: The addition of oxygen to a compound. More generally, any reaction which involves the loss of electrons from an atom.
- pH: The negative logarithm of the hydrogen-ion concentration. The concentration is the weight of hydrogen ions, in grams, per liter or solution. Neutral water, for example, has a pH value of 7 and a hydrogen ion concentration of  $10^{-7}$ .
- packer: In well drilling, a device lowered in the lining tubes which swells automatically or can be expanded by manipulation from the surface at the correct time to produce a water-tight joint against the sides of the borehole or the casing, thus entirely excluding water from different horizons.
- percentage map: A facies map that depicts the relative amount (thickness) of a single rock type in a given stratigraphic unit.
- permeability: The property or capacity of a porous rock, sediment, or soil for transmitting a fluid without impairment of the structure of the medium; it is a measure of the relative ease of fluid flow under unequal pressure. The customary unit of measurement is the millidarcy.
- piezometric surface: See potentiometric surface.
- plugging: The act or process of stopping the flow of water, oil, or gas in strata penetrated by a borehole or well so that fluid from one stratum will not escape into another or to the surface; especially the sealing up a well that is tube abandoned. It is usually accomplished by inserting a plug into the hole, by sealing off cracks and openings in the

sidewalls of the hole, or by cementing a block inside the casing. Capping the hole with a metal plate should never be considered as an adequate method of plugging a well.

plugging records: A systematic listing of permanent or temporary abandonment of water, oil, gas, test, exploration and waste injection wells. The plugging record should contain a well log, description of amounts and types of plugging material used, the method employed for plugging, a description of formations which are sealed and a graphic log of the well showing formation location, formation thickness, and location of plugging structures.

polymerization: A chemical reaction in which two or more small molecules combine to form larger molecules that contain repeating structural units of the original molecules.

porosity: The property of a rock, soil, or other material of containing interstices. It is commonly expressed as a percentage of the bulk volume of material occupied by interstices, whether isolated or connected.

potentiometric surface: An imaginary surface representing the static head of ground water and defined by the level to which water will rise in a well. The water table is a particular potentiometric surface.

pre-injection treatment: The conditioning of a liquid waste to remove or neutralize substances which may be damaging to the injection system equipment or tend to plug the system.

pressure: (1) The total load or force acting on a surface. (2) In hydraulics, without qualifications, usually the pressure per unit area or intensity of pressure above local atmospheric pressure expressed, for example, in pounds per square inch, kilograms per square centimeter.

pressure flotation: A process in which the wastewater is saturated with air under pressure and then passed into a floatation chamber at atmospheric pressure. Under reduced pressure, the air is released from solution as small bubbles that carry the oil globules to the surface, where they are skimmed off.

primary cementing: Is the process of placing cement behind the casing to fill the annular space between the casing and the open hole. It also functions: (1) to bond the casing to the formation, (2) to protect injection zones - reduces caving, (3) to seal off fresh water or mineral zones, (4) to isolate high pressure zones, (5) and protects casing from corrosive waters.

primary porosity: The porosity that develops during the final stages of sedimentation or that was present within sedimentary particles at the time of deposition. It includes all depositional porosity of the sediments, or the rock.

ratio-type lithofacies map: A map showing areal relations of lithofacies based on limiting values of two ratios, commonly clastic and sand-shale ratios.

rapid sand filters: There are two types: (1) Gravity rapid sand are composed of a bed several feet thick that is generally deposited as several layers of varying grain sizes, with fine sand at the top and gravel at the base. Anthracite of varying particle size is also used as a filter medium. A typical rate of flow is 2 gpm per ft<sup>2</sup>. (2) Pressure sand filter - pressure sand filters are based on the same principles as the gravity-feed rapid sand filter, except that the filter media and underdrain system are placed in a cylindrical tank, and the water is passed through the filter under pressure.

reduction: The opposite of oxidation. The chemical action which works to decrease the positive valence of an ion.

reverse rotary drilling: A method of drilling wells where waste material is carried away by water or mud forced up the inside of the drill pipe rather than the outside of the pipe as in the normal rotary drilling technique. Greater upward velocities in the small interior area add a greater waste carrying capacity.

rotary drilling: A common method of drilling, being a hydraulic process consisting of a rotating drill pipe at the bottom of which is attached to a hard-toothed drill bit. The rotary motion is transmitted through the pipe from a rotary table at the surface: as the pipe turns, the bit loosens or grinds a hole in the bottom material. During drilling, a stream of drilling mud is in constant circulation down the pipe and out through the bit from where it and the cuttings from the bit are forced back up the hole outside the pipe and into pits where the cuttings are removed and the mud is picked up by pumps and forced back down the pipe.

secondary cementing: Is used for maintenance repair operations, and is undertaken to plug damaged casing, caving injection zones and to abandon inefficient injection wells.

secondary porosity: The porosity developed in a rock formation subsequent to its deposition or emplacement, either through natural processes of dissolution, stress distortion, or artificially through acidization or the mechanical injection of coarse sand.

sedimentation: The process of removal of solids from water by gravity settling.

seismic survey: The gathering of seismic data from an area; the initial phase of seismic prospecting.

sequestering agent: A chemical that causes the coordination complex of certain phosphates with metallic ions in solution so that they may no longer be precipitated. Hexametaphosphates are an example: calcium soap pre-



precipitates are not produced from hard water treated with them. Also, any agent that prevents an ion from exhibiting its usual properties because of close combination with an added material.

settling reservoir: A reservoir consisting of a series of shallow basins arranged in steps and connected by long conduits allowing the removal of only the clear upper layer of water in each basin.

sludge: (1) Mud obtained from a drill hole in boring; mud from drill cuttings. The term has also been used for the cuttings produced by drilling. (2) A semi-fluid, slushy, and murky mass or sediment of solid matter resulting from treatment of water, sewage, or industrial and mining wastes, and often appearing as local bottom deposits in polluted bodies of water.

slow sand filter: A filter composed of beds of granular particles classified as slow which implies a very low flow velocity ( $<0.2$  gpm/ft<sup>2</sup>). This filter is not generally useful for pre-injection treatment.

slurry: A very wet, highly mobile, semiviscous mixture or suspension of finely divided, insoluble matter.

solubility: The equilibrium concentration of a solute in a solution saturated with respect to that solute at a given temperature and pressure.

solution: A process of chemical weathering by which rock material passes into calcium carbonate in limestone or chalk by carbonic acid derived from rainwater containing carbon dioxide acquired during its passage through the atmosphere.

solution cavity: (a) An opening produced by direct solution by water penetrating pre-existing interstices. (b) An opening resulting from the decomposition of less soluble rocks by water penetrating pre-existing interstices, followed by solution and removal of the decomposition products. (c) solution channel.

specific capacity: The rate of discharge of a water well per unit of draw-down, commonly expressed in gallons per minute per foot. It varies slowly with duration of discharge. If the specific capacity is constant except for the time variation, it is proportional to the transmissivity of the aquifer.

specific conductance: The electrical conductivity of a water sample at 25° C. (77° F), expressed in micro-ohms per centimeter.

specific gravity: The ratio of the mass of a body to the mass of an equal volume of water.

- specific yield: The ratio of the volume of water a given mass of saturated rock or soil will yield by gravity to the volume of that mass. This ratio is stated as a percentage. Cf: effective porosity; storage coefficient.
- storage coefficient: In an aquifer, the volume of water released from storage in a vertical column of 1.0 square feet when the water table or other potentiometric surface declines 1.0 foot. In an unconfined aquifer, it is approximately equal to the specific yield.
- structure-contour map: A map that portrays subsurface configuration by means of structure contour lines; contour map; tectonic map. Syn: structural map; structure map.
- sulfate-reducing bacteria: Anaerobic bacteria capable of assimilating oxygen from sulfate compounds, thereby reducing them to sulfides.
- surface casing: The first string of well casing to be installed in the well. The length will vary according to the surface conditions and the type of well.
- surfactant: An abbreviation for surface-active agent. The active agent in detergents that possesses a high cleaning ability. These agents in solution exhibit special characteristics that include concentrations of interfaces, formation of micelles, solubilization, the lowering of surface tension, and the increased penetration of the liquid in which they are dissolved.
- surge: A momentary increase in flow in an open conduit or pressure in a closed conduit that passes longitudinally along the conduit, usually due to sudden changes in velocity.
- suspended solids: (1) Solids that either float on the surface of, or are in suspension in, water, wastewater, or other liquids, and which are largely removable by laboratory filtering. (2) The quantity of material removed from wastewater in a laboratory test, as prescribed in "Standard Methods for the Examination of Water and Wastewater" and referred to as nonfilterable residue.
- swab: A piston-like device equipped with an upward-opening check valve and provided with flexible rubber suction caps, lowered into a borehole or casing by means of a wire line for the purpose of cleaning out drilling mud or of lifting oil.
- tectonic: Said of or pertaining to the forces involved in, or the resulting structures or features of, tectonics. Syn: geotectonic.
- test hole: A general term for any type of hole, pit, shaft, etc., dug or drilled for subsurface reconnaissance.

**thinner:** Is applied to a substance that reduces the apparent viscosity and gel development of mud without lowering the density. The effectiveness of a thinner depends upon the condition of the mud, the pH, and the amount of the contaminants present.

**tie-back liner:** A liner which extends from the top of a liner all the way back to the surface. They are fully cemented to protect other casing strings against pressure and/or corrosion.

**total porosity:** The measure of all void space of a rock, soil or other substance. Total porosity is usually expressed as a percentage of the bulk volume of material occupied by the void space.

**toxin:** A colloidal, proteinaceous, poisonous substance that is a specific product of the metabolic activities of a living organism and is usually very unstable, notably toxic when introduced into the tissues and typically capable of inducing antibody formation.

**transmissivity:** In an aquifer, the rate of which water of the prevailing kinematic viscosity is transmitted through a unit width under a unit hydraulic gradient. Though spoken of as a property of the aquifer, it embodies also the saturated thickness and the properties of the contained liquid.

**turbidity:** The state, condition, or quality of opaqueness or reduced clarity of a fluid, due to the presence of suspended matter. A measure of the ability of suspended material to disturb or diminish the penetration of light through a fluid.

**unconsolidated material:** A sediment that is loosely arranged, or whose particles are not cemented together, occurring either at the surface or at depth.

**viscosity:** The property of a substance to offer internal resistance to flow; its internal friction. Specifically, the ratio of the rate of shear stress to the rate of shear strain. This ratio is known as the coefficient of viscosity.

**volatile chemicals:** Chemicals capable of being evaporated at relatively low temperatures.

**wastewater:** Spent water. According to the source, it may be a combination of the liquid and water-carried wastes from residence, commercial buildings, industrial plants, and institutions, together with any ground water, surface water, and storm water which may be present. In recent years, the term wastewater has taken precedence over the term sewage.

**water quality:** The chemical, physical, and biological characteristics of water with respect to its suitability for a particular purpose.

**well log:** A log obtained from a well, showing such information as resistivity, radioactivity, spontaneous potential, and acoustic velocity as a function of depth; esp. a lithologic record of the rocks penetrated.

- well plug: A water tight and gas tight seal installed in a borehole or well to prevent movement of fluids. The plug can be a block cemented inside the casing.
- well record: A concise statement of the available data regarding a well, such as a scout ticket; a full history or day-by-day account of a well, from the day the well was surveyed to the day production ceased.
- well stimulation: Term used to describe several processes used to clean the well bore, enlarge channels, and increase pore space in the interval to be injected thus making it possible for wastewater to move more readily into the formation. The following are well stimulation techniques: (1) surging, (2) jetting, (3) blasting, (4) acidizing, and (5) hydraulic fracturing.
- well monitoring: The measurement, by on-site instruments or laboratory methods, of the water quality of a water well. Monitoring may be periodic or continuous.
- WOC: "Waiting on Cement" is the period beginning when the plug bumps the float collars and ends when the cement plug is drilled out. It is required for the cement to attain required strength.

**TECHNICAL REPORT DATA**

*(Please read Instructions on the reverse before completing)*

1. REPORT NO. EPA-600/2-77-240	2.	3. RECIPIENT'S ACCESSION NO.
4. TITLE AND SUBTITLE AN INTRODUCTION TO THE TECHNOLOGY OF SUBSURFACE WASTEWATER INJECTION	5. REPORT DATE December 1977 issuing date	6. PERFORMING ORGANIZATION CODE
	8. PERFORMING ORGANIZATION REPORT NO.	
7. AUTHOR(S) Don L. Warner, University of Missouri--Rolla Jay H. Lehr, NWWA	10. PROGRAM ELEMENT NO. ICC614	
9. PERFORMING ORGANIZATION NAME AND ADDRESS National Water Well Association 500 West Wilson Bridge Road Worthington, Ohio 43085	11. CONTRACT/GRANT NO. No. R-803889	
	13. TYPE OF REPORT AND PERIOD COVERED Final (July '75 - July '77)	14. SPONSORING AGENCY CODE EPA/600/15 EPA/600/14
12. SPONSORING AGENCY NAME AND ADDRESS Robert S. Kerr Environmental Research Lab. - Ada, OK Office of Research and Development U.S. Environmental Protection Agency Ada, Oklahoma 74820		
15. SUPPLEMENTARY NOTES This report was co-sponsored by the Municipal Environmental Research Laboratory, Office of Research and Development, U.S. Environmental Protection Agency, Cincinnati, Ohio 45268		
16. ABSTRACT  An introduction to the design, construction, operation, and abandonment of subsurface wastewater injection systems is presented.  Local geologic and hydrologic characteristics of the injection and confining intervals are considered along with the physical, chemical, and biological compatibility of the receiving zone with the wastewater to be injected.  Design and construction aspects of injection wells are presented along with recommended preinjection testing, operating procedures, and emergency precautions. Monitoring requirements are discussed, in addition to records maintenance and proper well abandonment procedures.		
17. KEY WORDS AND DOCUMENT ANALYSIS		
DESCRIPTORS Injection Wells Waste Disposal Design Construction	IDENTIFIERS OPEN ENDED TERMS Technology Development Underground Disposal Monitoring	COSATI Field Group 13 B
18. STATEMENT OF WORK OR CONTRACT NUMBER Release to Public	19. SECURITY CLASSIFICATION Unclassified	20. NUMBER OF PAGES 355

